

INSTRUCTION MANUAL

TECO INVERTER

200V Class

1/3 phase 0.75~2.2KW
1~3HP

3 phase 3.7~110KW
5~150HP

400V Class

3 phase 0.75~315KW
1~425HP



TECO INVERTER

A510 Series

Table of Contents

Preface	0-1
Chapter 1 Safety Precautions	1-1
1.1 Before Supplying Power to the Inverter.....	1-1
1.2 Wiring.....	1-2
1.3 Before Operation	1-3
1.4 Parameters Setting.....	1-3
1.5 Operation	1-4
1.6 Maintenance, Inspection and Replacement	1-5
1.7 Disposal of the Inverter.....	1-5
Chapter 2 Model Description	2-1
2.1 Nameplate Data.....	2-1
2.2 Inverter Models – Motor Power Rating (HD-Heavy Duty)	2-2
Chapter 3 Environment and Installation	3-1
3.1 Environment.....	3-1
3.2 Installation.....	3-2
3.3 External View.....	3-3
3.4 Warning Labels.....	3-5
3.5 Removing the Front Cover and Keypad.....	3-6
3.5.1 Standard type.....	3-6
3.5.2 Built-in filter type (400V 1 ~60HP).....	3-12
3.6 Wire Gauges and Tightening Torque	3-13
3.7 Wiring Peripheral Power Devices	3-14
3.8 General Wiring Diagram	3-16
3.9 User Terminals	3-17
3.10 Power Terminals.....	3-21
3.11 Input / Output Section Block Diagram	3-24
3.11.1 Cooling Fan Supply Voltage Selection (400V class)	3-28
3.12 Inverter Wiring	3-29
3.13 Input Power and Motor Cable Length.....	3-30

3.14 Cable Length vs, Carrier Frequency.....	3-30
3.15 Installing an AC Line Reactor	3-30
3.16 Power Input Wire Size, NFB and MCB Part Numbers	3-31
3.17 Control Circuit Wiring.....	3-33
3.18 Inverter Specifications	3-35
3.19 Inverter Derating Based on Carrier Frequency	3-41
3.20 Inverter Derating Based on Temperature.....	3-43
3.21 Inverter Dimensions.....	3-44
3.22 Dimensions for Models with Built-in Filter	3-51
Chapter 4 Keypad and Programming Functions.....	4-1
4.1 LED Keypad.....	4-1
4.1.1 Keypad Display and Keys	4-1
4.1.2 Seven Segment Display Description.....	4-3
4.1.3 LED Indicator Description.....	4-5
4.1.4 Power-up Monitor.....	4-7
4.1.5 Modifying Parameters/ Set Frequency Reference.....	4-8
4.1.6 Operation Control.....	4-10
4.2 LCD Keypad (Option).....	4-11
4.2.1 Keypad Display and Keys	4-11
4.2.2 Keypad Menu Structure	4-13
4.3 Parameters	4-18
4.4 Description of Parameters	4-61
4.5 Built-in PLC Function	4-257
4.5.1 Basic Command.....	4-257
4.5.2 Basic Command Function.....	4-258
4.5.3 Application Functions.....	4-259
4.6 Modbus Protocol Descriptions.....	4-268
4.6.1 Communication Connection and Data Frame.....	4-268
4.6.2 Register and Data Format.....	4-272
4.6.3 Parameter Data.....	4-280
Chapter 5 Check Motor Rotation and Direction	5-1

Chapter 6 Speed Reference Command Configuration	6-1
6.1 Reference from the Keypad.....	6-1
6.2 Reference from External Analog Signal (0-10V / 4-20mA).....	6-2
6.3 Reference from Serial Communication RS485	6-4
6.4 Reference from Pulse Input.....	6-6
6.5 Reference from two Analog Inputs	6-7
6.6 Change Frequency Unit from Hz to rpm.....	6-7
Chapter 7 Operation Method Configuration (Run / Stop).....	7-1
7.1 Run / Stop from the LED/ LCD Keypad.....	7-1
7.2 Run / Stop from External Switch / Contact or Pushbutton.....	7-2
7.3 Run / Stop from Serial Communication RS485.....	7-4
Chapter 8 Motor and Application Specific Settings.....	8-1
8.1 Set Motor Nameplate Data	8-1
8.2 Acceleration and Deceleration Time.....	8-2
8.3 Torque Compensation Gain	8-3
8.4 Automatic Energy Saving Functions.....	8-4
8.5 Emergency Stop	8-6
8.6 Forward and Reverse Jog	8-7
8.7 Direct / Unattended Startup	8-7
8.8 Analog Output Setup	8-8
Chapter 9 Using PID Control for Constant Flow / Pressure Applications	9-1
9.1 What is PID Control	9-1
9.2 Connect Transducer Feedback Signal	9-3
9.3 Engineering Units	9-4
9.4 Sleep / Wakeup Function	9-5



Chapter 10 Troubleshooting and Fault Diagnostics	10-1
10.1 General	10-1
10.2 Fault Detection Function.....	10-1
10.3 Warning / Self-diagnosis Detection Function	10-7
10.4 Auto-tuning Error	10-15
10.5 PM Motor Auto-tuning Error.....	10-16
Chapter 11 Inverter Peripheral Devices and Options	11-1
11.1 Braking Resistors and Braking Units	11-1
11.2 AC Line Reactors.....	11-4
11.3 Harmonic Filters.....	11-6
11.4 Input Noise Filters.....	11-10
11.5 Output Filters	11-12
11.6 Input Current and Fuse Specifications	11-14
11.7 PG Speed Feedback Card	11-16
11.8 Other Options	11-20
11.9 Communication Options	11-22
11.10 Protective Cover	11-22
Appendix A: Communication Networks	A1-1
A1.1 RS485-- Network (Modbus)	A1-1
A1.2 Profibus DP Network	A1-2
Appendix B: UL Instructions	B-1

Information provided by **EMAG**
Tel: 01902 601403
www.emag-ltd.co.uk

Preface

The A510 product is an inverter designed to control a three-phase induction motor. Please read this manual carefully to ensure correct operation, safety and to become familiar with the inverter functions.

The A510 inverter is an electrical / electronic product and must be installed and handled by qualified service personnel.

Improper handling may result in incorrect operation, shorter life cycle, or failure of this product as well as the motor.

All A510 documentation is subject to change without notice. Be sure to obtain the latest editions for use or visit our website at <http://globalsa.teco.com.tw>



Available Documentation:

1. A510 Start-up and Installation Manual
2. A510 Instruction Manual

Ensure you have sound knowledge of the device and familiarize yourself with all safety information and precautions before proceeding to operate the inverter.

Ensure you have sound knowledge of the inverter and familiarize yourself with all safety information and precautions before proceeding to operate the inverter.

Please pay close attention to the safety precautions indicated by the warning  and caution  symbol.

 Warning	Failure to ignore the information indicated by the warning symbol may result in death or serious injury.
 Caution	Failure to ignore the information indicated by the caution symbol may result in minor or moderate injury and/or substantial property damage.

Chapter 1 Safety Precautions

1.1 Before Supplying Power to the Inverter



Warning

The main circuit must be correctly wired. For single phase supply use input terminals (R/L1, T/L3) and for three phase supply use input terminals (R/L1, S/L2, T/L3). Terminals U/T1, V/T2, W/T3 must only be used to connect the motor. Connecting the input supply to any of the U/T1, V/T2 or W/T3 terminals will cause damage to the inverter.



Caution

- To avoid the front cover from disengaging or other physical damage, do not carry the inverter by its cover. Support the unit by its heat sink when transporting. Improper handling can damage the inverter or injure personnel, and should be avoided.
- To avoid the risk of fire, do not install the inverter on or near flammable objects. Install on nonflammable objects such as metal surfaces.
- If several inverters are placed inside the same control panel, provide adequate ventilation to maintain the temperature below 40°C/104°F (50°C/122°F) without a dust cover) to avoid overheating or fire.
- When removing or installing the digital operator, turn off the power first, and then follow the instructions in this manual to avoid operator error or loss of display caused by faulty connections.



Warning

- This product is sold subject to IEC 61800-3. In a domestic environment this product may cause radio interference in which case the user may need to apply corrective measures.
- **Motor over temperature protection is not provided.**

1.2 Wiring



Warning

- Always turn OFF the power supply before attempting inverter installation and wiring of the user terminals.
- Wiring must be performed by a qualified personnel / certified electrician.
- Make sure the inverter is properly grounded. (200V Class: Grounding impedance shall be less than 100Ω. 400V Class: Grounding impedance shall be less than 10Ω.)
- Please check and test emergency stop circuits after wiring. (Installer is responsible for the correct wiring.)
- Never touch any of the input or output power lines directly or allow any input or output power lines to come in contact with the inverter case.
- Do not perform a dielectric voltage withstand test (megger) on the inverter this will result in inverter damage to the semiconductor components.



Caution

- The line voltage applied must comply with the inverter's specified input voltage. (See product nameplate section 2.1)
- Connect braking resistor and braking unit to the designated terminals. (See section 3.10)
- Do not connect a braking resistor directly to the DC terminals P (+) and N (-), otherwise fire may result.
- Use wire gauge recommendations and torque specifications. (See Wire Gauge and Torque Specification section 3.6)
- Never connect input power to the inverter output terminals U/T1, V/T2, W/T3.
- Do not connect a contactor or switch in series with the inverter and the motor.
- Do not connect a power factor correction capacitor or surge suppressor to the inverter output.
- Ensure the interference generated by the inverter and motor does not affect peripheral devices.

1.3 Before Operation



Warning

- Make sure the inverter capacity matches the parameters 13-00.
- Reduce the carrier frequency (parameter 11-01) if the cable from the inverter to the motor is greater than 80 ft (25m). A high-frequency current can be generated by stray capacitance between the cables and result in an overcurrent trip of the inverter, an increase in leakage current, or an inaccurate current readout.
- Be sure to install all covers before turning on power. Do not remove any of the covers while power to the inverter is on, otherwise electric shock may occur.
- Do not operate switches with wet hands, otherwise electric shock may result.
- Do not touch inverter terminals when energized even if inverter has stopped, otherwise electric shock may result.

1.4 Parameters Setting



Caution

- Do not connect a load to the motor while performing a rotational auto-tune.
- Make sure the motor can freely run and there is sufficient space around the motor when performing a rotational auto-tune.

1.5 Operation



Warning

- Be sure to install all covers before turning on power. Do not remove any of the covers while power to the inverter is on, otherwise electric shock may occur.
- Do not connect or disconnect the motor during operation. This will cause the inverter to trip and may cause damage to the inverter.
- Operations may start suddenly if an alarm or fault is reset with a run command active. Confirm that no run command is active upon resetting the alarm or fault, otherwise accidents may occur.
- Do not operate switches with wet hands, otherwise electric shock may result.
- It provides an independent external hardware emergency switch, which emergently shuts down the inverter output in the case of danger.
- If automatic restart after power recovery (parameter 07-00) is enabled, the inverter will start automatically after power is restored.
- Make sure it is safe to operate the inverter and motor before performing a rotational auto-tune.
- Do not touch inverter terminals when energized even if inverter has stopped, otherwise electric shock may result.
- Do not check signals on circuit boards while the inverter is running.
- After the power is turned off, the cooling fan may continue to run for some time.



Caution

- Do not touch heat-generating components such as heat sinks and braking resistors.
- Carefully check the performance of motor or machine before operating at high speed, otherwise Injury may result.
- Note the parameter settings related to the braking unit when applicable.
- Do not use the inverter braking function for mechanical holding, otherwise injury may result.
- Do not check signals on circuit boards while the inverter is running.

1.6 Maintenance, Inspection and Replacement



Warning

- Wait a minimum of five minutes after power has been turned OFF before starting an inspection. Also confirm that the charge light is OFF and that the DC bus voltage has dropped below 25Vdc.
- Never touch high voltage terminals in the inverter.
- Make sure power to the inverter is disconnected before disassembling the inverter.
- Only authorized personnel should perform maintenance, inspection, and replacement operations. (Take off metal jewelry such as watches and rings and use insulated tools.)



Caution

- The Inverter can be used in an environment with a temperature range from 14° -104°F (-10-40°C) and relative humidity of 95% non-condensing.
- The inverter must be operated in a dust, gas, mist and moisture free environment.

1.7 Disposal of the Inverter



Caution

- Please dispose of this unit with care as an industrial waste and according to your required local regulations.
- The capacitors of inverter main circuit and printed circuit board are considered as hazardous waste and must not be burned.
- The Plastic enclosure and parts of the inverter such as the top cover board will release harmful gases if burned.

Chapter 2 Model Description

2.1 Nameplate Data

It is essential to verify the A510 inverter nameplate and make sure that the A510 inverter has the correct rating so it can be used in your application with the proper sized AC motor.

Unpack the A510 inverter and check the following:

- (1) The A510 inverter and start-up and installation manual are contained in the package.
- (2) The A510 inverter has not been damaged during transportation there should be no dents or parts missing.
- (3) The A510 inverter is the type you ordered. You can check the type and specifications on the main nameplate.
- (4) Check that the input voltage range meets the input power requirements.
- (5) Ensure that the motor HP matches the motor rating of the inverter.

HD: Heavy Duty (Constant Torque); ND: Normal Duty (Variable Torque) (1HP = 0.746 kW)

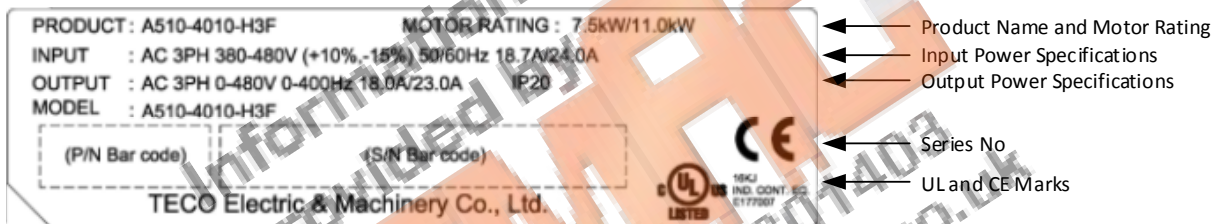

Model Identification

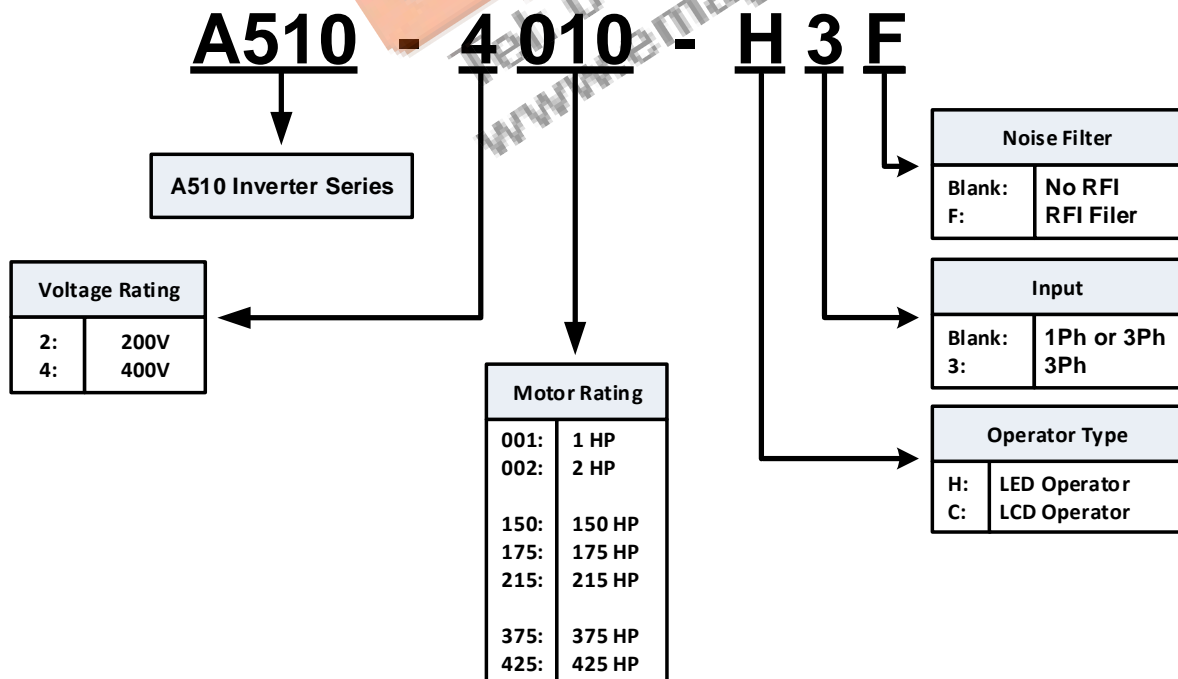

2.2 Inverter Models – Motor Power Rating (HD – Heavy Duty)

200V Class

Voltage	A510 Model	Applied Motor (HP)	Applied Motor (KW)	Filter	
				with	without
1ph/3ph, 200~240V +10%/-15% 50/60Hz	A510-2001-H	1	0.75		⊙
	A510-2002-H	2	1.5		⊙
	A510-2003-H	3	2.2		⊙
3ph, 200~240V +10%/-15% 50/60Hz	A510-2005-H3	5	3.7		⊙
	A510-2008-H3	7.5	5.5		⊙
	A510-2010-H3	10	7.5		⊙
	A510-2015-H3	15	11		⊙
	A510-2020-H3	20	15		⊙
	A510-2025-H3	25	18.5		⊙
	A510-2030-H3	30	22		⊙
	A510-2040-H3	40	30		⊙
	A510-2050-H3	50	37		⊙
	A510-2060-H3	60	45		⊙
	A510-2075-H3	75	55		⊙
	A510-2100-H3	100	75		⊙
	A510-2125-H3	125	94		⊙
A510-2150-H3	150	112		⊙	

Short Circuit Rating: 200V Class: 5kA

400V Class

Voltage	A510 Model	Applied Motor (HP)	Applied Motor (KW)	Filter	
				with	without
3ph, 380~480V +10%/-15% 50/60Hz	A510-4001-H3	1	0.75		⊙
	A510-4001-H3F	1	0.75	⊙	
	A510-4002-H3	2	1.5		⊙
	A510-4002-H3F	2	1.5	⊙	
	A510-4003-H3	3	2.2		⊙
	A510-4003-H3F	3	2.2	⊙	
	A510-4005-H3	5	3.7		⊙
	A510-4005-H3F	5	3.7	⊙	
	A510-4008-H3	7.5	5.5		⊙
	A510-4008-H3F	7.5	5.5	⊙	
	A510-4010-H3	10	7.5		⊙
	A510-4010-H3F	10	7.5	⊙	
	A510-4015-H3	15	11		⊙
	A510-4015-H3F	15	11	⊙	
	A510-4020-H3	20	15		⊙
	A510-4020-H3F	20	15	⊙	
	A510-4025-H3	25	18.5		⊙
	A510-4025-H3F	25	18.5	⊙	
	A510-4030-H3	30	22		⊙
	A510-4030-H3F	30	22	⊙	
	A510-4040-H3	40	30		⊙
	A510-4040-H3F	40	30	⊙	
	A510-4050-H3	50	37		⊙
	A510-4050-H3F	50	37	⊙	
	A510-4060-H3	60	45		⊙
	A510-4060-H3F	60	45	⊙	
	A510-4075-H3	75	55		⊙
	A510-4100-H3	100	75		⊙
	A510-4125-H3	125	94		⊙
	A510-4150-H3	150	112		⊙
A510-4175-H3	175	130		⊙	
A510-4215-H3	215	160		⊙	
A510-4250-H3	250	185		⊙	
A510-4300-H3	300	220		⊙	
A510-4375-H3	375	280		⊙	
A510-4425-H3	425	315		⊙	

Short Circuit Rating: 400V Class: 5kA

Chapter 3 Environment and Installation

3.1 Environment

The environment will directly affect the proper operation and the life span of the inverter. To ensure that the inverter will give maximum service life, please comply with the following environmental conditions:

Protection	
Protection Class	IP20/NEMA 1 or IP00
Operating Temperature	Ambient Temperature: (-10°C - +40°C (14 -104 °F) Without Cover: -10°C - +50°C (14-122 °F) If several inverters are placed in the same control panel, provide a heat removal means to maintain ambient temperatures below 40°C
Storage Temperature	-20°C - +70°C (-4 -158 °F)
Humidity	95% non-condensing Relative humidity 5% to 95%, free of moisture. (Follow IEC60068-2-78 standard)
Altitude	< 1000m (3,281 ft.)
Installation Site	Avoid exposure to rain or moisture.
	Avoid direct sunlight.
	Avoid oil mist and salinity.
	Avoid corrosive liquid and gas.
	Avoid dust, lint fibers, and small metal filings.
	Keep away from radioactive and flammable materials.
	Avoid electromagnetic interference (soldering machines, power machines).
Avoid vibration (stamping, punching machines etc.). Add a vibration-proof pad if the situation cannot be avoided.	
Shock	Maximum acceleration: 1.2G (12m/s ²), from 49.84 to 150 Hz Displacement amplitude : 0.3mm (peak value), from 10 to 49.84 Hz (Follow IEC60068-2-6 standard)

3.2 Installation

When installing the inverter, ensure that inverter is installed in upright position (vertical direction) and there is adequate space around the unit to allow normal heat dissipation as per the following Fig. 3.2.1

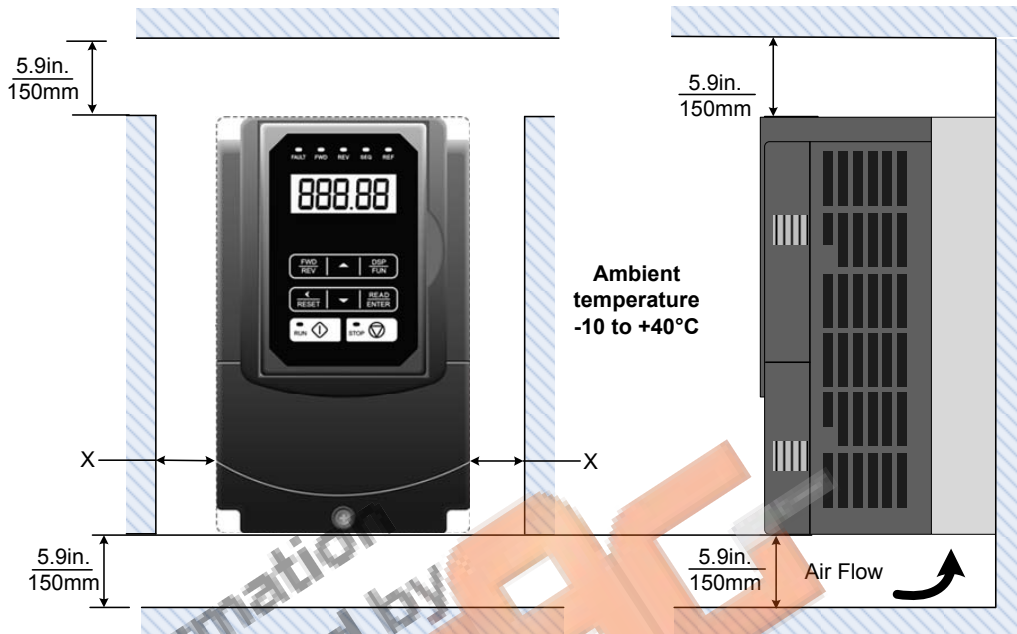

Fig 3.2.1: A510 Installation space

X = 1.18" (30mm) for inverter ratings up to 25HP

X = 1.96" (50mm) for inverter ratings 30HP or higher

Important Note: The inverter heatsink temperature can reach up to 194°F / 90°C during operation; make sure to use insulation material rated for this temperature.

3.3 External View

(a) 200V 1 ~ 5 HP / 400V 1 ~ 7.5 HP

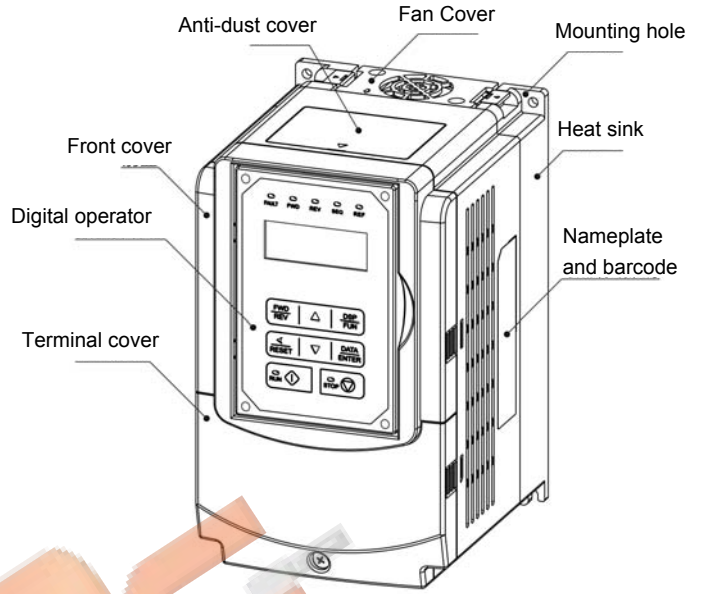
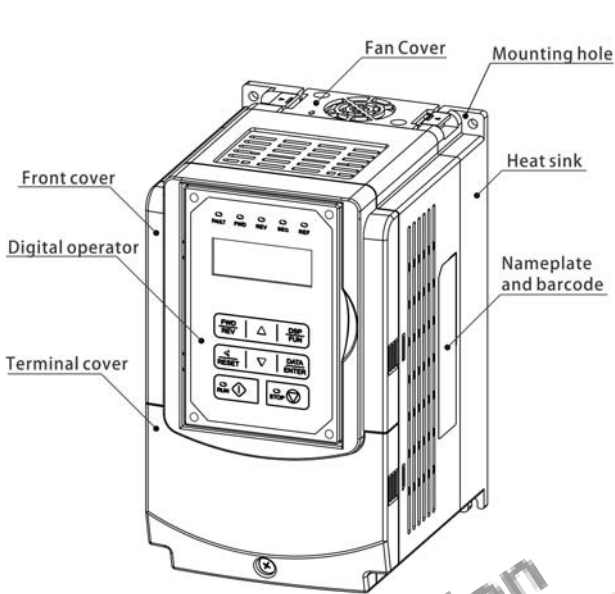

(Wall-mounted type, IEC IP20)

(Wall-mounted type, IEC IP20, NEMA1)

(b) 200V 7.5 ~ 25 HP / 400V 10 ~ 30 HP

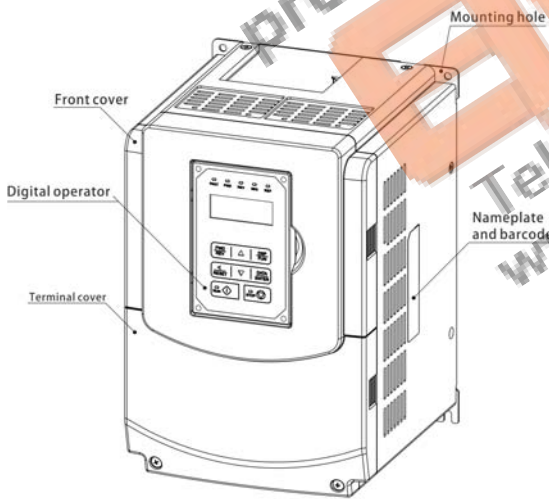

(Wall-mounted type, IEC IP20)

(Wall-mounted type, IEC IP20, NEMA1)

(c) 200V 30 ~ 40 HP / 400V 40 ~ 60 HP

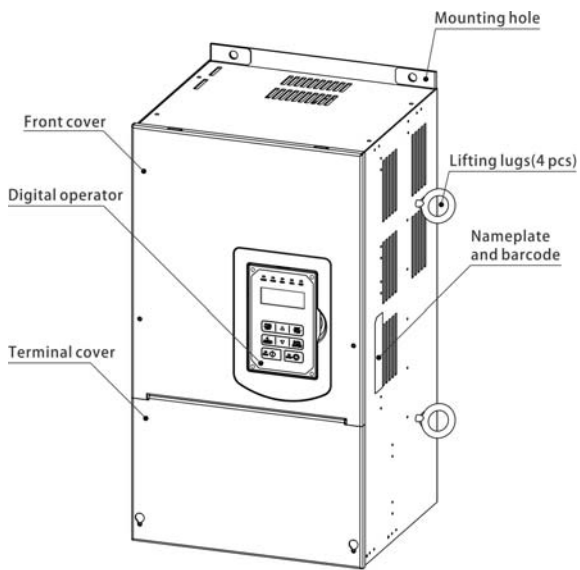

(Wall-mounted type, IEC IP20, NEMA1)

(d) 200V 50 ~ 100 HP / 400V 75 ~ 215 HP

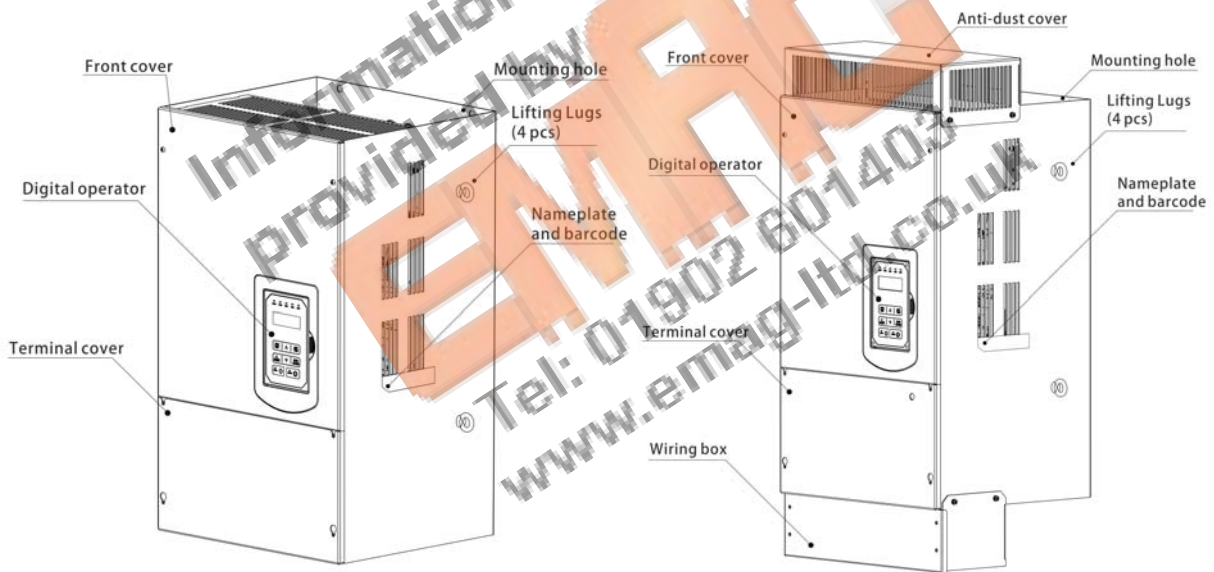

(Wall-mounted type, IEC IP00)

(Wall-mounted type, IEC IP20, NEMA1)

(e) 200V 125 ~ 150 HP / 400V 250 ~ 425 HP

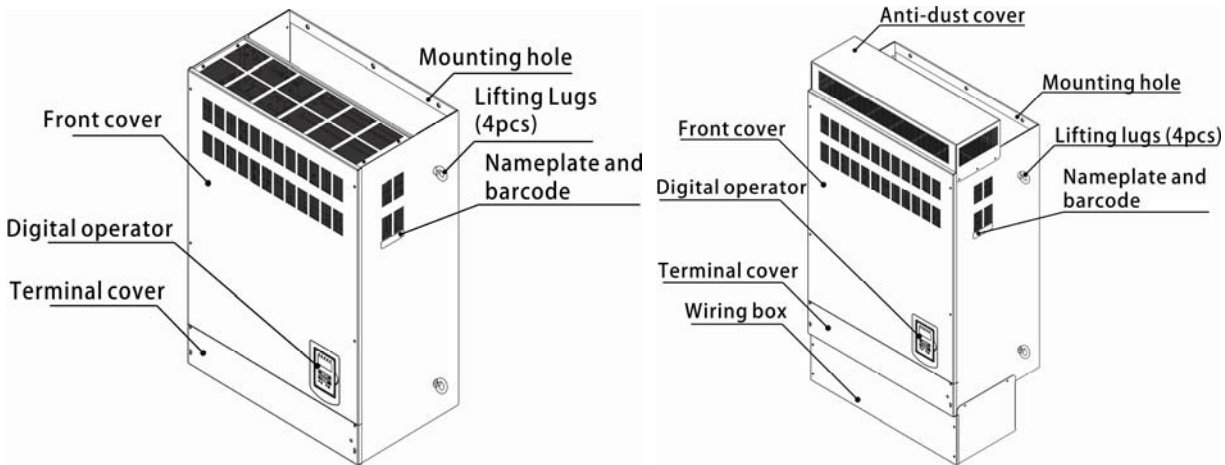

(Wall-mounted type, IEC IP00)

(Wall-mounted type, IEC IP20, NEMA1)

3.4 Warning Labels

Important: Warning information located on the front cover must be read upon installation of the inverter.



(a) 200V: 1 ~ 5HP / 400V: 1 ~ 7.5HP



(b) 200V: 7.5 ~ 10HP / 400V: 10 ~ 15HP

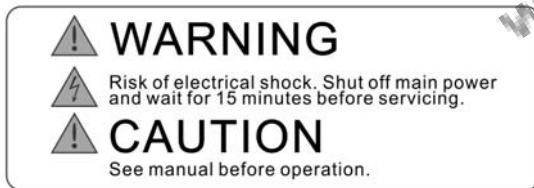

(c) 200V: 15 ~ 150HP / 400V: 20 ~ 425HP

3.5 Removing the Front Cover and Keypad

Caution

- Before making any wiring connections to the inverter the front cover needs to be removed.
- It is not required to remove the digital operator before making any wiring connections.
- Models 200V, 1 – 25 HP and 400V, 1 – 30 HP have a plastic cover. Loosen the screws and remove the cover to gain access to the terminals and make wiring connections. Place the plastic cover back and fasten screws when wiring connections have been made.
- Models 200V, 1 - 25HP and 400V, 1 - 30HP have a metal cover. Loosen the screws and remove the cover to gain access to the terminals and make wiring connections. Place the metal cover back and fasten screws when wiring connections have been made.

3.5.1 Standard Type

(a) 200V: 1 ~ 5 HP / 400V: 1 ~ 7.5 HP

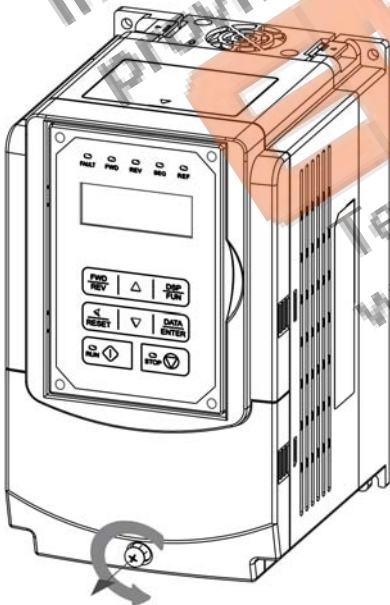

Step 1: Unscrew

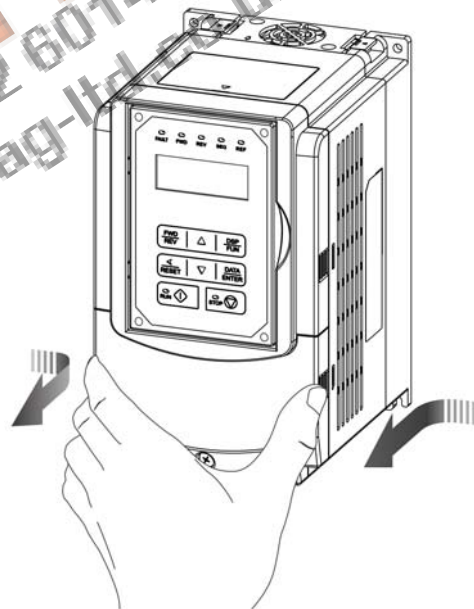

Step 2: Remove cover

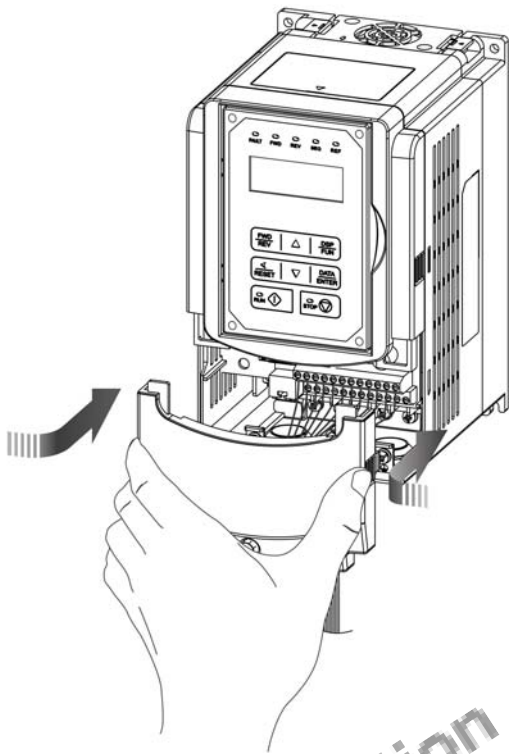

Step 3: Make wire connections and place cover back

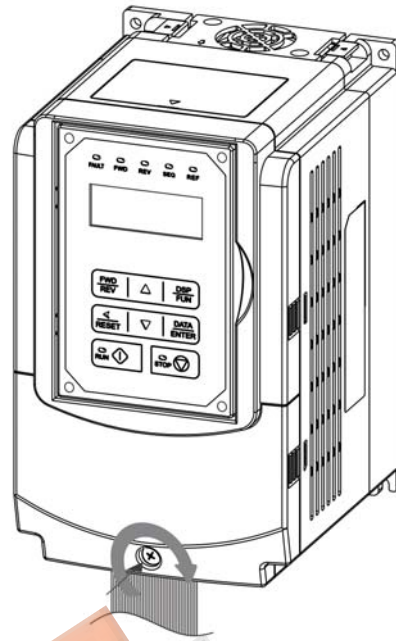

Step 4: Fasten screw

(b) 200V: 7.5 ~ 25 HP / 400V: 10 ~ 30 HP

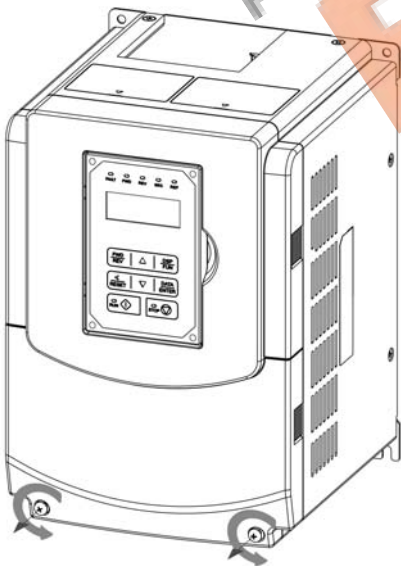

Step 1: Unscrew cover

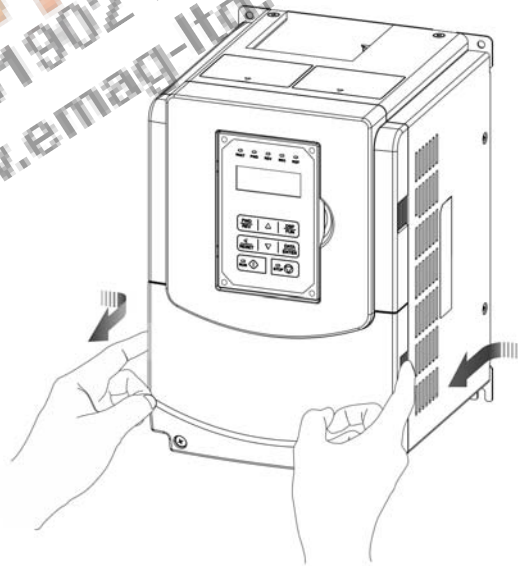

Step 2: Remove cover

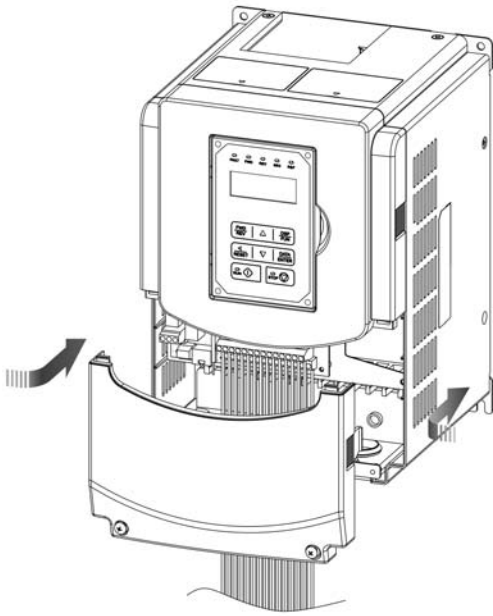

Step 3: Make wire connections and place cover back

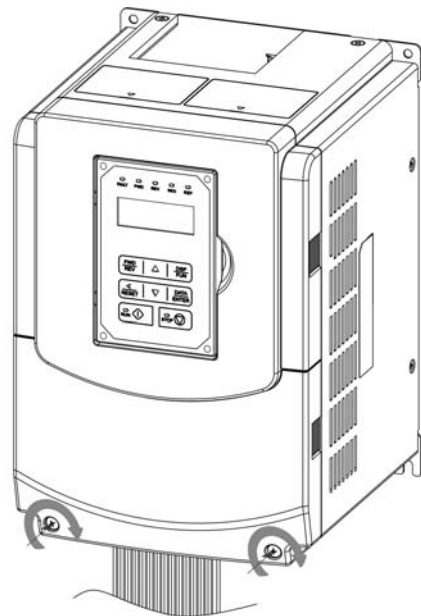

Step 4: Fasten screw

(c) 200V: 30 ~ 40 HP / 400V: 40 ~ 60 HP (Chassis Type)

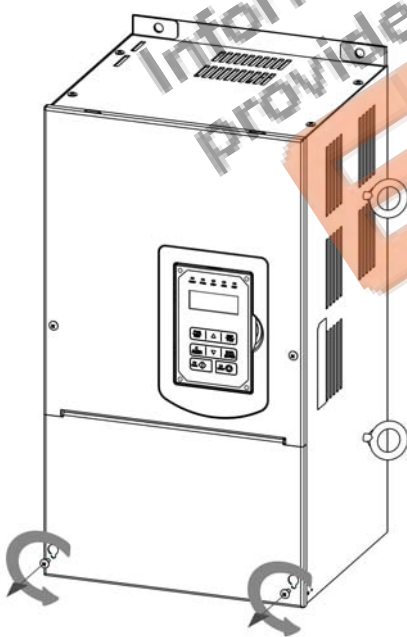

Step 1: Unscrew cover

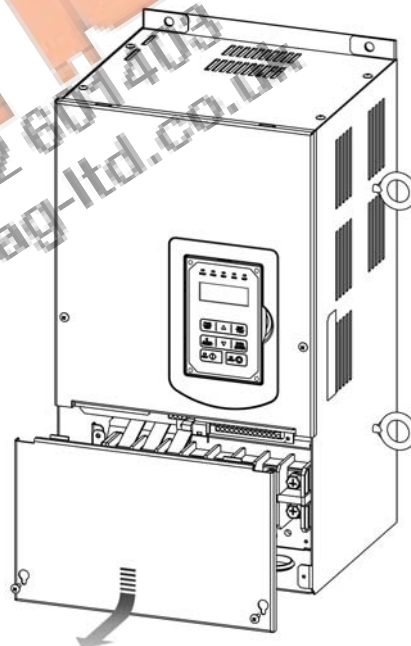

Step 2: Remove cover

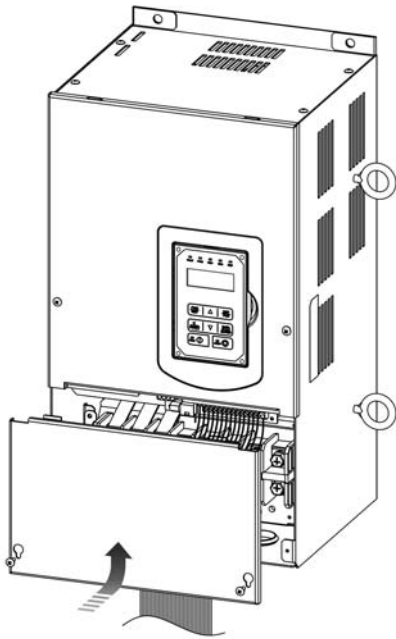

Step 3: Make wire connections and place cover back

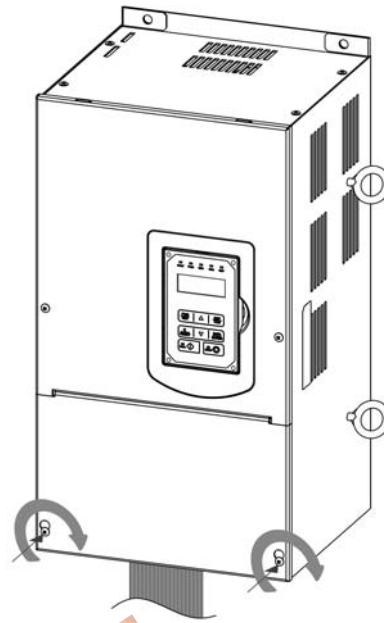

Step 4: Fasten screw

(d) 200V: 50 ~ 100 HP / 400V: 75 ~ 215 HP (Chassis Type)

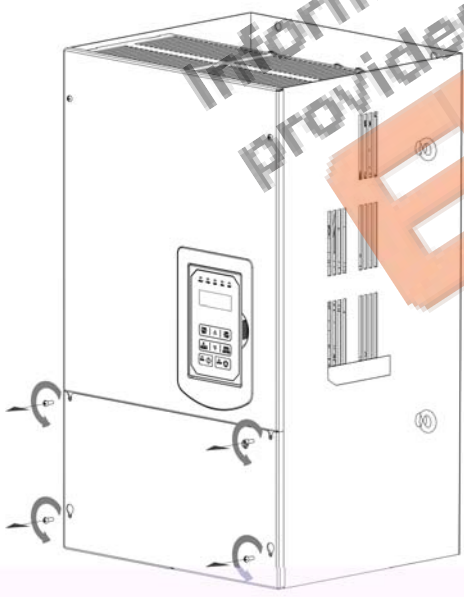

Step 1: Unscrew cover

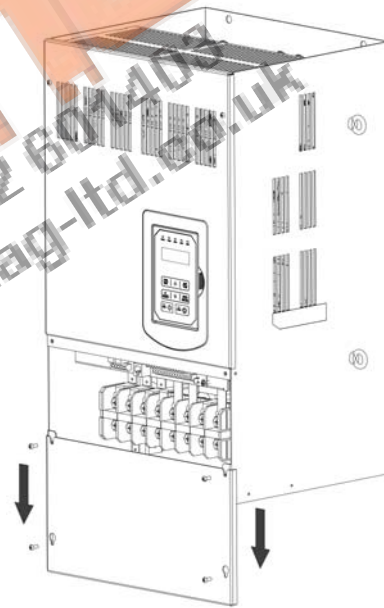

Step 2: Remove cover

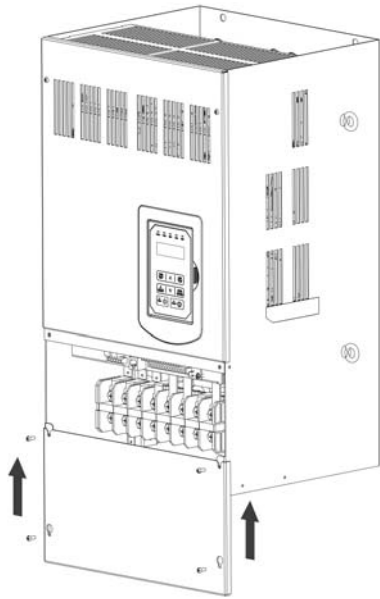

Step 3: Make wire connections and place cover back

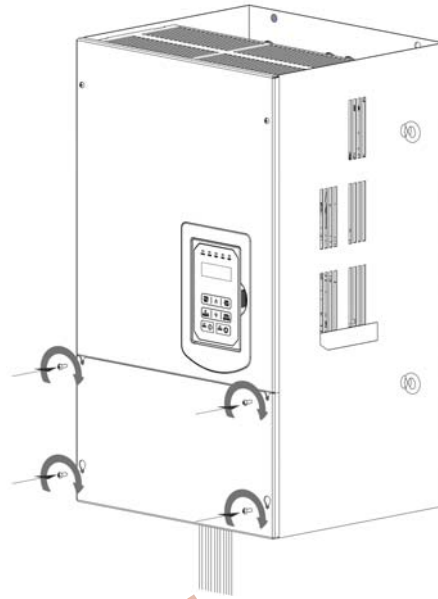

Step 4: Fasten screw

(e) 200V: 125 ~ 150 HP / 400V: 250 ~ 425 HP (Chassis Type)



Step 1: Unscrew cover

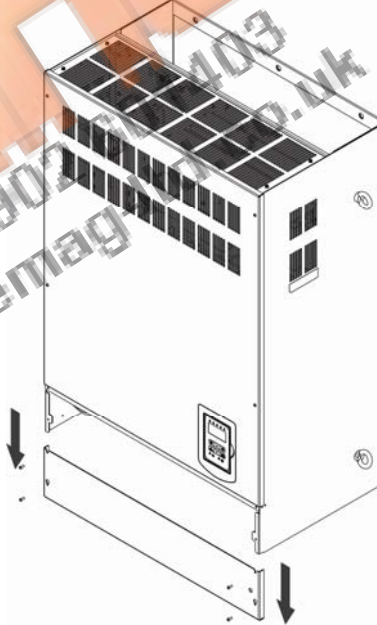

Step 2: Remove cover

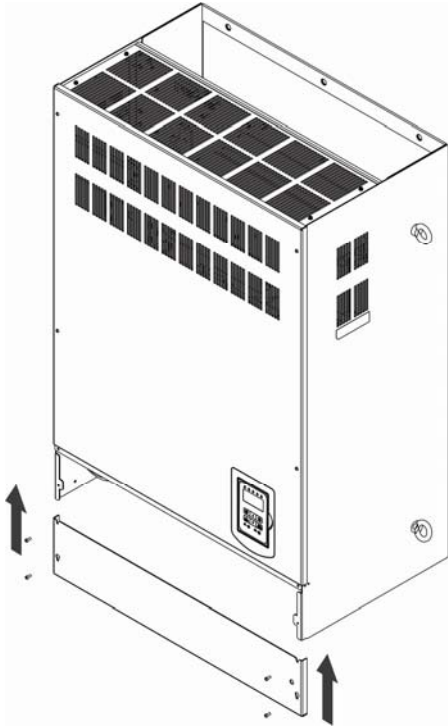

Step 3: Make wire connections and place cover back

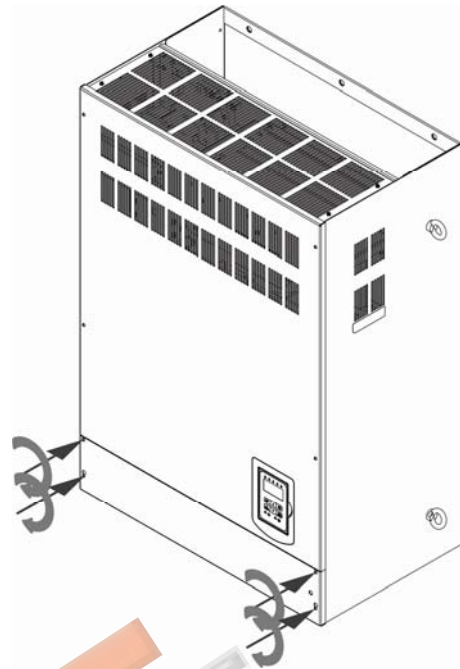

Step 4: Fasten screw

Information
provided by
EMAG
Tel: 01902 601403
www.emag-ltd.co.uk

3.5.2 Built-in filter type (400V: 1 ~ 60 HP)



Step 1: Unscrew cover

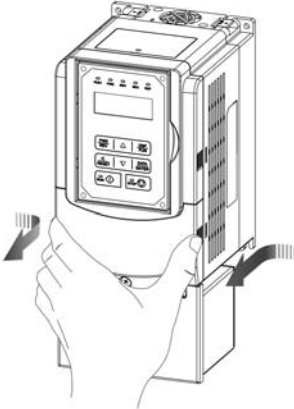

Step 2: Remove cover

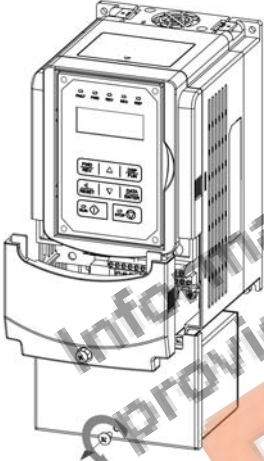

Step 3: Unscrew filter section

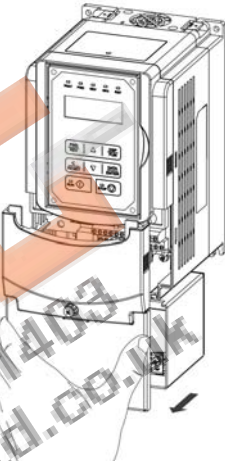

Step 4: Remove filter cover

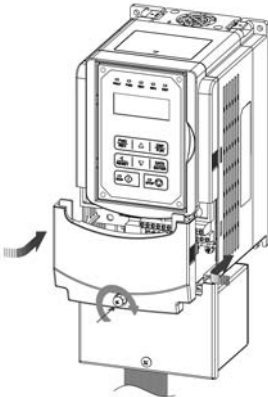

Step 5: Make connections and place filter cover back

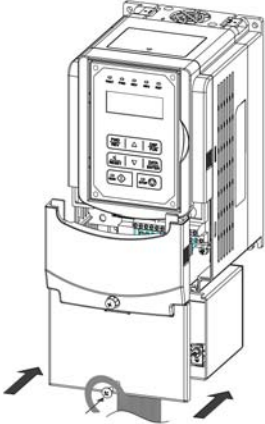

Step 6: Fasten screw

Information provided by **EMAG**
Tel: 01902 601403
www.emag-ltd.co.uk

3.6 Wire Gauges and Tightening Torque

To comply with UL standards, use UL approved copper wires (rated 75° C) and round crimp terminals (UL Listed products) as shown in table below when connecting to the main circuit terminals. TECO recommends using crimp terminals manufactured by NICHIFU Terminal Industry Co., Ltd and the terminal crimping tool recommended by the manufacturer for crimping terminals and the insulating sleeve.

Wire size mm ² (AWG)	Terminal screw size	Model of the round crimp terminal	Fastening torque kgf.cm (in.lbs)	Model of insulating sleeve	Model of crimp tool
0.75 (18)	M3.5	R1.25-3.5	8.2 to 10 (7.1 to 8.7)	TIC 1.25	NH 1
	M4	R1.25-4	12.2 to 14 (10.4 to 12.1)	TIC 1.25	NH 1
1.25 (16)	M3.5	R1.25-3.5	8.2 to 10 (7.1 to 8.7)	TIC 1.25	NH 1
	M4	R1.25-4	12.2 to 14 (10.4 to 12.1)	TIC 1.25	NH 1
2 (14)	M3.5	R2-3.5	8.2 to 10 (7.1 to 8.7)	TIC 2	NH 1 / 9
	M4	R2-4	12.2 to 14 (10.4 to 12.1)	TIC 2	NH 1 / 9
	M5	R2-5	22.1 to 24 (17.7 to 20.8)	TIC 2	NH 1 / 9
	M6	R2-6	25.5 to 30.0 (22.1 to 26.0)	TIC 2	NH 1 / 9
3.5 / 5.5 (12/10)	M4	R5.5-4	12.2 to 14 (10.4 to 12.1)	TIC 5.5	NH 1 / 9
	M5	R5.5-5	20.4 to 24 (17.7 to 20.8)	TIC 5.5	NH 1 / 9
	M6	R5.5-6	25.5 to 30.0 (22.1 to 26.0)	TIC 5.5	NH 1 / 9
	M8	R5.5-8	61.2 to 66.0 (53.0 to 57.2)	TIC 5.5	NH 1 / 9
8 (8)	M4	R8-4	12.2 to 14 (10.4 to 12.1)	TIC 8	NOP 60
	M5	R8-5	20.4 to 24 (17.7 to 20.8)	TIC 8	NOP 60
	M6	R8-6	25.5 to 30.0 (22.1 to 26.0)	TIC 8	NOP 60
	M8	R8-8	61.2 to 66.0 (53.0 to 57.2)	TIC 8	NOP 60
14 (6)	M4	R14-4	12.2 to 14 (10.4 to 12.1)	TIC 14	NH 1 / 9
	M5	R14-5	20.4 to 24 (17.7 to 20.8)	TIC 14	NH 1 / 9
	M6	R14-6	25.5 to 30.0 (22.1 to 26.0)	TIC 14	NH 1 / 9
	M8	R14-8	61.2 to 66.0 (53.0 to 57.2)	TIC 14	NH 1 / 9
22 (4)	M6	R22-6	25.5 to 30.0 (22.1 to 26.0)	TIC 22	NOP 60/ 150H
	M8	R22-8	61.2 to 66.0 (53.0 to 57.2)	TIC 22	NOP 60/ 150H
30 / 38 (3 / 2)	M6	R38-6	25.5 to 30.0 (22.1 to 26.0)	TIC 38	NOP 60/ 150H
	M8	R38-8	61.2 to 66.0 (53.0 to 57.2)	TIC 38	NOP 60/ 150H
50 / 60 (1/1/0)	M8	R60-8	61.2 to 66.0 (53.0 to 57.2)	TIC 60	NOP 60/ 150H
	M10	R60-10	102 to 120 (88.5 to 104)	TIC 60	NOP 150H
70 (2/0)	M8	R70-8	61.2 to 66.0 (53.0 to 57.2)	TIC 60	NOP 150H
	M10	R70-10	102 to 120 (88.5 to 104)	TIC 60	NOP 150H
80 (3/0)	M10	R80-10	102 to 120 (88.5 to 104)	TIC 80	NOP 150H
	M16	R80-16	255 to 280 (221 to 243)	TIC 80	NOP 150H
100 (4/0)	M10	R100-10	102 to 120 (88.5 to 104)	TIC 100	NOP 150H
	M12	R100-12	143 to 157 (124 to 136)	TIC 100	NOP 150H
	M16	R80-16	255 to 280 (221 to 243)	TIC 80	NOP 150H

3.7 Wiring Peripheral Power Devices

 **Caution**

- After power is shut off to the inverter the capacitors will slowly discharge. Do NOT touch and of the inverter circuitry or replace any components until the “CHARGE” indicator is off.
- Do NOT wire or connect/disconnect internal connectors of the inverter when the inverter is powered up or when powered off and the “CHARGE” indicator is on.
- Do NOT connect inverter output U, V and W to the supply power. This will result in damage to the inverter.
- The inverter must be properly grounded. Use terminal E to connect earth ground and comply with local standards.
- Do NOT perform a dielectric voltage withstand test (Megger) on the inverter this will result in inverter damage to the semiconductor components.
- Do NOT touch any of the components on the inverter control board to prevent damage to the inverter by static electricity.

 **Caution**

- Refer to the recommended wire size table for the appropriate wire to use. The voltage between the power supply and the input of the inverter may not exceed 2%.

Phase-to-phase voltage drop (V) = $\sqrt{3}$ × resistance of wire (Ω/km) × length of line m) × current × 10⁻³.
(km=3280 x feet) / (m=3.28 x feet)

- Reduce the carrier frequency (parameter 11-01) If the cable from the inverter to the motor is greater than 25m (82ft). A high-frequency current can be generated by stray capacitance between the cables and result in an overcurrent trip of the inverter, an increase in leakage current, or an inaccurate current readout.
- To protect peripheral equipment, install fast acting fuses on the input side of the inverter. Refer to section 11.6 for additional information.

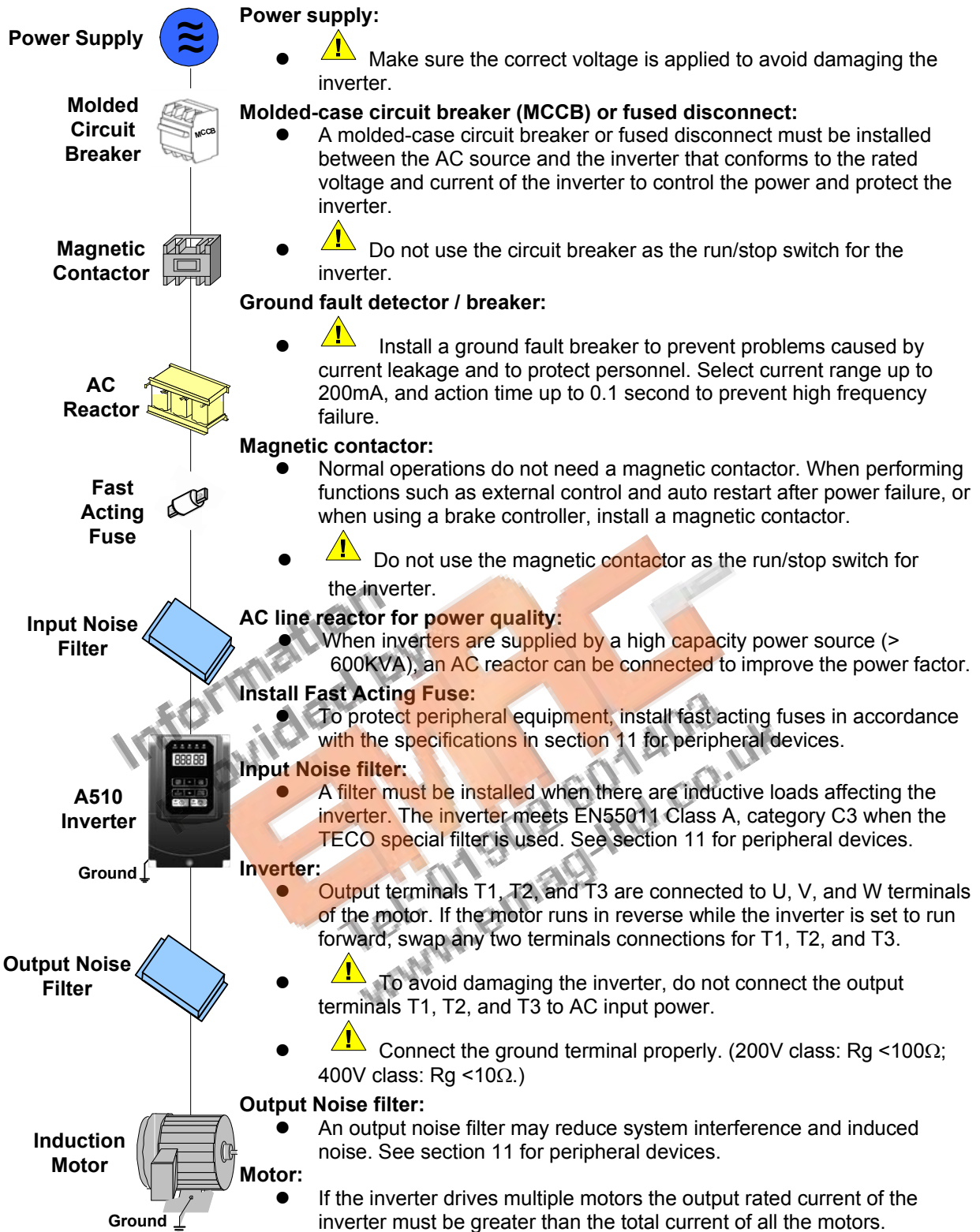

3.8 General Wiring Diagram

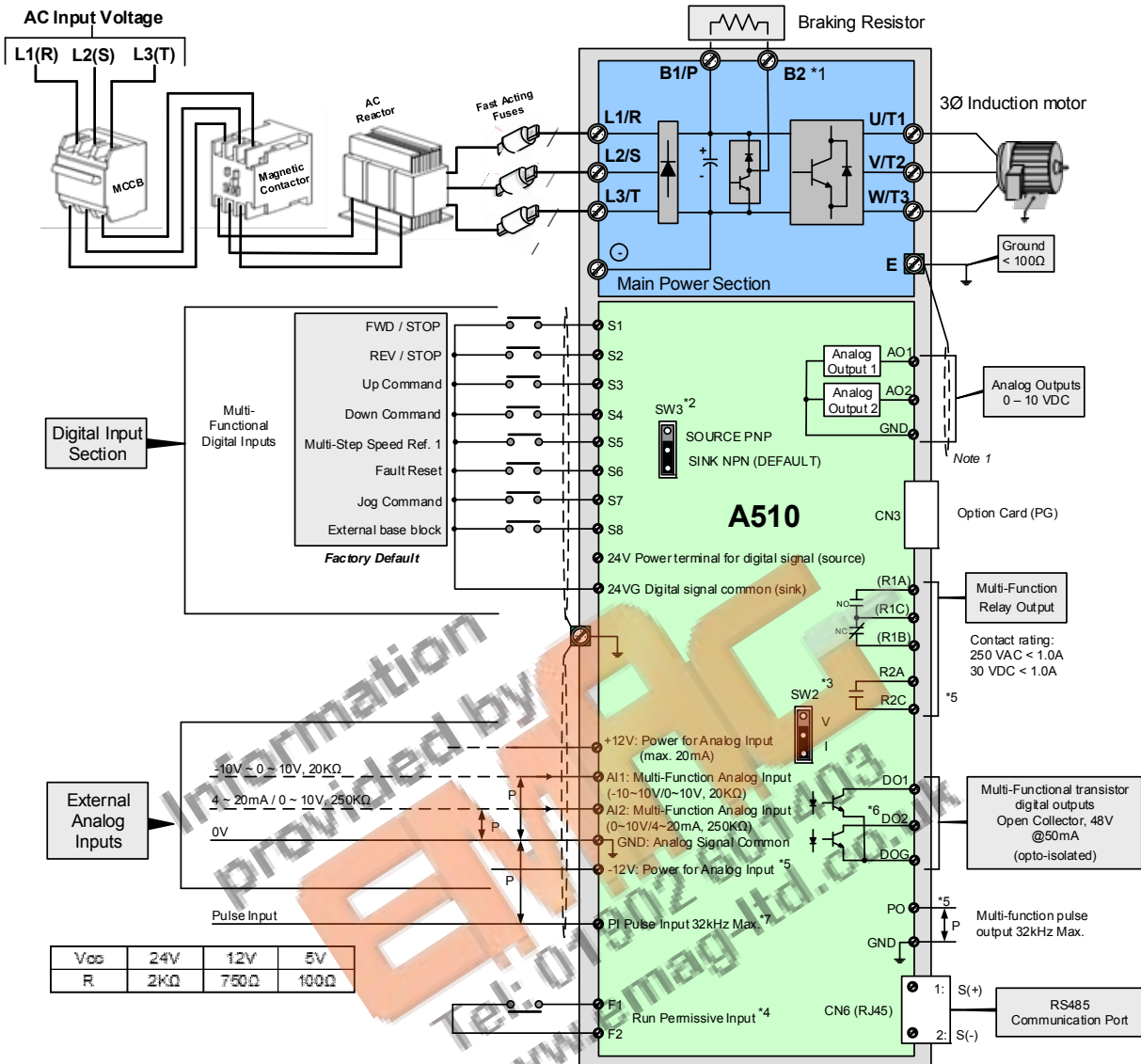

Notes:

- *1: Models 200V 1 ~ 25HP and 400V 1 ~ 30HP or lower ratings have a built-in braking transistor. To use this braking transistor a braking resistor can be connected between B1 and B2.
- *2: Use SW3 to select between Sink (NPN, with 24VG common) or Source (PNP, with +24V common) for multi-function digital input terminals S1~S8.
- *3: Use SW2 to switch between voltage and current input for Multi-function analog input 2 (AI2).
- *4: Run Permissive input F1 and F2 is a normally closed input. This input should be closed to enable the inverter output. To activate this input remove the jumper wire between F1 and F2.
- *5: Models 200V 3HP and 400V 5HP and higher ratings include terminals -12V, R2A-R2C and PO-GND.
- *6: 200V 2HP and 400V 3HP and lower ratings include terminal DO2.
- *7: When using the open collector for pulse input, the connected resistors need to follow the input voltage.

3.9 User Terminals (Control Circuit Terminals)

200V: 1 ~ 2 HP, 400V: 1 ~ 3HP

E	DO2	24VG	S2	S4	S6	S8	24V	+12V	GND	A1	A2
DO1	DOG	S1	S3	S5	S7	F1	F2	PI	AO1	AO2	E
R1A	R1B	R1C									

200V: 3 ~ 40 HP, 400V: 5 ~ 60HP

E	24VG	S1	S3	S5	S7	24V	+12V	GND	-12V	GND	GND	A1	A2
DO1	DOG	S2	S4	S6	S8	F1	F2	E	PO	PI	AO1	AO2	E
R1A	R1B	R1C											
		R2A	R2C										

200V: 50 ~ 150 HP, 400V: 75 ~ 425HP

E	24VG	S1	S3	S5	S7	24V	+12V	GND	-12V	GND	GND	A1	A2
DO1	DOG	S2	S4	S6	S8	F1	F2	E	PO	PI	AO1	AO2	E
R2A	R2C	R1A	R1B	R1C									

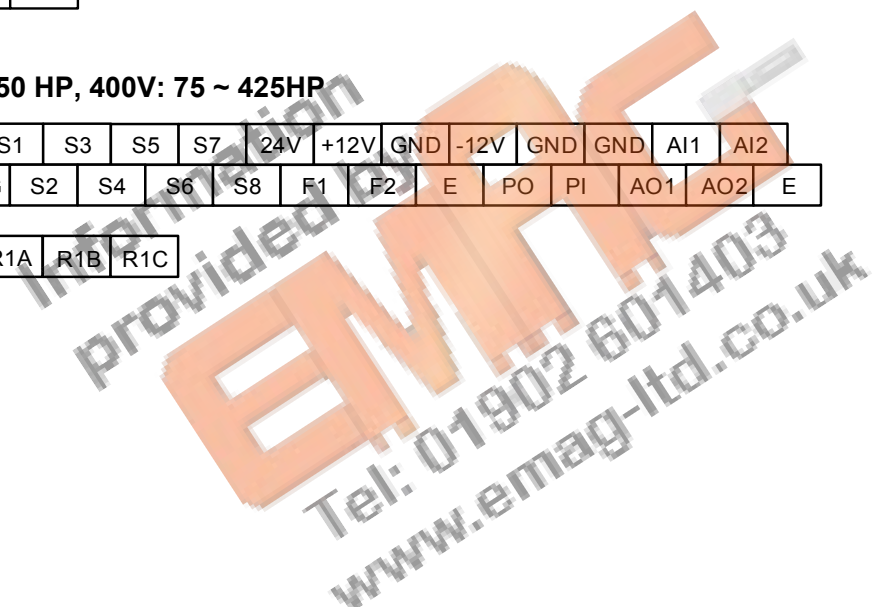

Description of User Terminals

Type	Terminal	Terminal Function	Signal Level / Information
Digital input signal	S1	Forward rotation— stop command (default), multi-function input terminals * 1	Signal Level 24 VDC (opto isolated) Maximum current: 8mA Maximum voltage: 30 Vdc Input impedance: 9.03kΩ
	S2	Reversal rotation- stop command (default), multi-function input terminals * 1	
	S3	UP command(default), multi-function input terminals * 1	
	S4	DOWN command(default), multi-function input terminals * 1	
	S5	Multi-step speed frequency command 1, multi-function input terminal* 1	
	S6	Fault reset input, multi-function input terminal * 1	
	S7	JOG frequency command, multi-function input terminal * 1	
	S8	External B.B.(Base Block) input, multi-function input terminal * 1	
24V Power supply	24V	Digital signal SOURCE point (SW3 switched to SOURCE)	±15%, Max. output current: 250mA (The sum of all loads connected)
	24VG	Common terminal of Digital signals Common point of digital signal SINK (SW3 switched to SINK)	
Analog input signal	+12V	Power for external speed potentiometer	+12V (Max. current , 20mA)
	-12V	Only above 200V 3HP/ 400V 5HP (include) support this terminal function	-12V (Max. current , 20mA)
	AI1	Multi-function analog input for speed reference (0-10V input)/(-10V~10V input)	From 0 to +10V, From -10V to +10V Input impedance : 20KΩ Resolution: 11bit + 1
	AI2	Multi-function analog input terminals *2, can use SW2 to switch voltage or current input (0~10V)/(4-20mA)	From 0 to +10V, From -10V to +10V Input impedance: 20KΩ From 4 to 20 mA Input impedance: 250KΩ Resolution: 11bit + 1
	GND	Analog signal ground terminal	----
	E	Shielding wire's connecting terminal (Ground)	----
Analog output signal	AO1	Multi-function analog output terminals *3 (0~10V output)	From 0 to 10V, Max. current: 20mA PWM Frequency: 10KHz
	AO2	Multi-function analog output terminals *3 (0~10V output)	
	GND	Analog signals ground terminal	
Pulse output signal	PO	Pulse output, Band width 32KHz, only above 200V 3HP/ 400V 5HP (include) support this terminal function.	Max. Frequency: 32KHz Open Collector output (Load: 2.2kΩ)

Type	Terminal	Terminal Function	Signal Level / Information
	GND	Analog signals ground terminal	----
Pulse input signal	PI	Pulse command input, frequency width of 32KHz	L: from 0.0 to 0.5V H: from 4.0 to 13.2V Max. Frequency: 0 - 32KHz Impedance: 3.89 KΩ
	GND	Analog signals ground terminal	----
Digital output	DO1	Multi-function(open collector resistor) output: in operation, zero speed, frequency consistency, consistency at any frequency, output frequency, preparation completion, low-voltage detection, output breaker, rotation and frequency command, over-torque detection, abnormal, low-voltage, Overheat, motor overload, inverter overload, retrying, communication error, timing functional output device.....	48Vdc, 2~50mA Open-collector output
	DO2 (Frame one only)		
	DOG	Open collector transistor digital ground	
Relay output	R1A	Relay A contact (multi-function output terminal)	Rating: 250Vac, 10 mA ~ 1A 30Vdc, 10 mA ~ 1A
	R1B	Relay B contact (multi-function output terminal)	
	R1C	Relay contact common terminal, With the same functions as DO1/DO2	
	R2A-R2C (Frame 2 and above)	With the same functions as DO1/DO2	Rating: 250Vac, 10 mA ~ 1A 30Vdc, 10 mA ~ 1A
Run Permissive Input	F1	On: normal operation. Off: stop.	24Vdc, 8mA, pull-up
	F2	(Jumper wired between F1 and F2 has to be removed by using external contact to stop.)	24V Ground
RS-485 port	S (+)	Modbus communication protocol	Max. Baud Rate: 38400 bps
	S (-)		
Grounding	E (G)	Grounding to earth Shield the connecting terminal	----

Notes:

*1:Multi-function digital input can be referred to in this manual.

- Group 03: External Terminals Digital Input / Output Function Group.

*2:Multi-function analog input can be referred to in this manual..

- Group 04 - External Terminal Analog Signal Input (Output) Function Group.

*3:Multi-function analog output can be referred to in this manual.

- Group 04 - External Terminal Analog Signal Input (Output) Function Group.

 **Caution**

- Maximum output current capacity for terminal 12V is 20mA.
- Multi-function analog output AO1 and AO2 are for use for an analog output meter. Do not use these output for feedback control.
- Control board's 24V and $\pm 12V$ are to be used for internal control only, Do not use the internal power-supply to power external devices.

Information
provided by
EMAG
Tel: 01902 601403
www.emag-ltd.co.uk

3.10 Power Terminals

Terminal	200V: 1 ~ 25HP 400V: 1 ~ 30HP	200V: 30 ~ 150HP 400V: 40 ~ 425HP
R/L1	Input Power Supply (For single phase use terminals R/L1 and S/L2)	
S/L2		
T/L3		
B1 / P	<ul style="list-style-type: none"> • B1 / P – ⊖: DC power supply • B1 / P – B2: external braking resistor 	<ul style="list-style-type: none"> • ⊕ - ⊖: DC power supply or connect braking module
B2		
⊖		
⊕	-	
U/T1	Inverter output	
V/T2		
W/T3		
E	Ground terminal	

200V: 1 ~ 2HP, 400V: 1 ~ 3HP

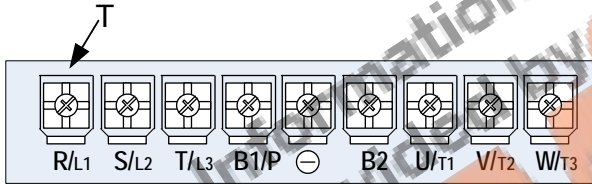

Terminal screw size	
T	⊖
M4	M4

200V: 3 ~ 5HP, 400V: 5 ~ 7.5HP

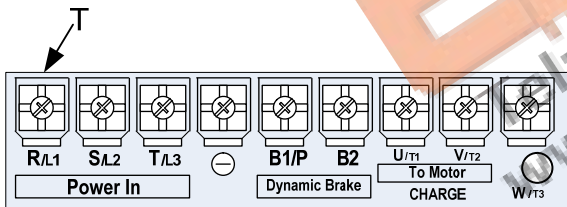

Terminal screw size	
T	⊖
M4	M4

200V: 7.5~10HP, 400V: 10 ~ 15HP

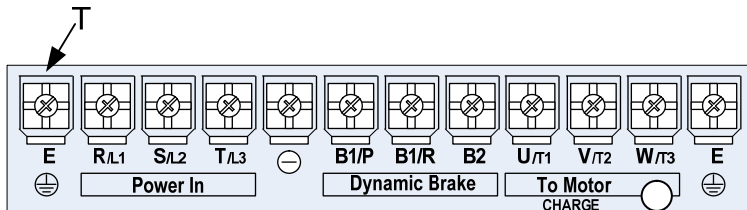

Terminal screw size	
T	⊖
M6	M6

200V: 15~25HP, 400V: 20 ~ 30HP

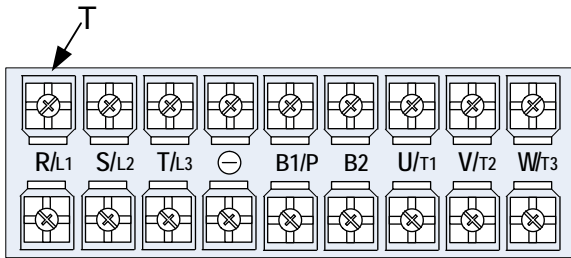

Terminal screw size	
T	⊕
M6	M6

200V: 30 ~40HP, 400V: 40 ~ 60HP

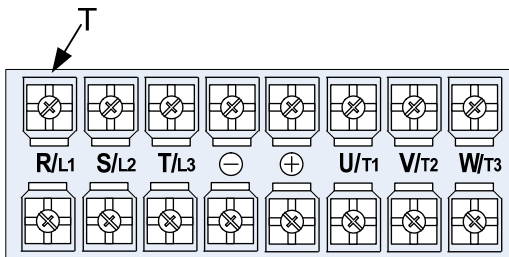

Terminal screw size	
T	⊕
M8	M8

200V: 50~60HP, 400V: 75~100HP

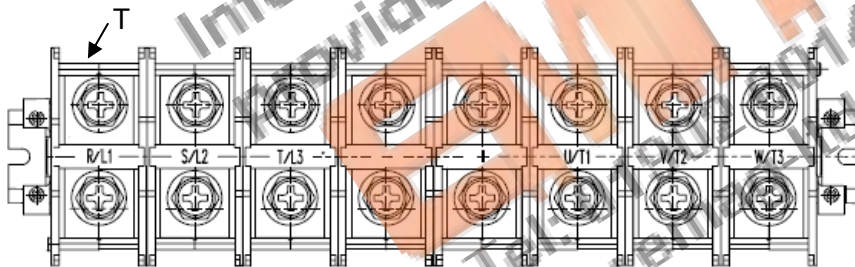

Terminal screw size		
Power supply	T	⊕
400V 75HP	M8	M10
200V 50-60HP/ 400V 100HP	M10	M10

200V: 75~100HP, 400V: 125~215HP

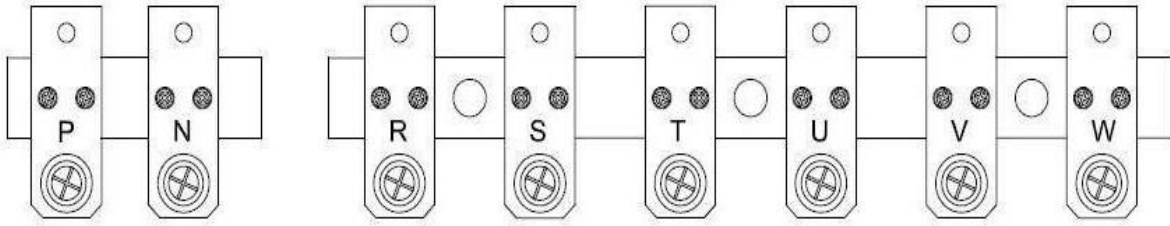

Terminal screw size	
T	⊕
M10	M10

200V: 125~150HP, 400V: 250~425HP

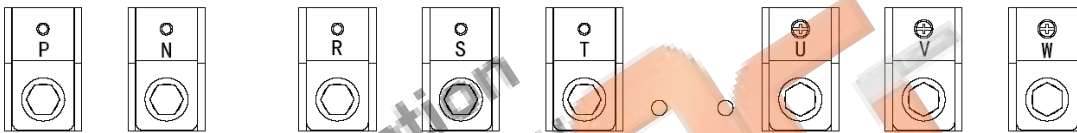

Terminal screw size	
T	⊕
M12	M10

Notes: For wire gauges and screw torques, please refer to the table in [section 3.6](#).

3.11 Input / Output Power Section Block Diagram

The following diagrams 1 - 8 show the basic configuration of the power sections for the range of horsepower and input voltages. This is shown for reference only and is not a detailed depiction.

1: 200V: 1 HP / 400V: 1 ~ 2 HP

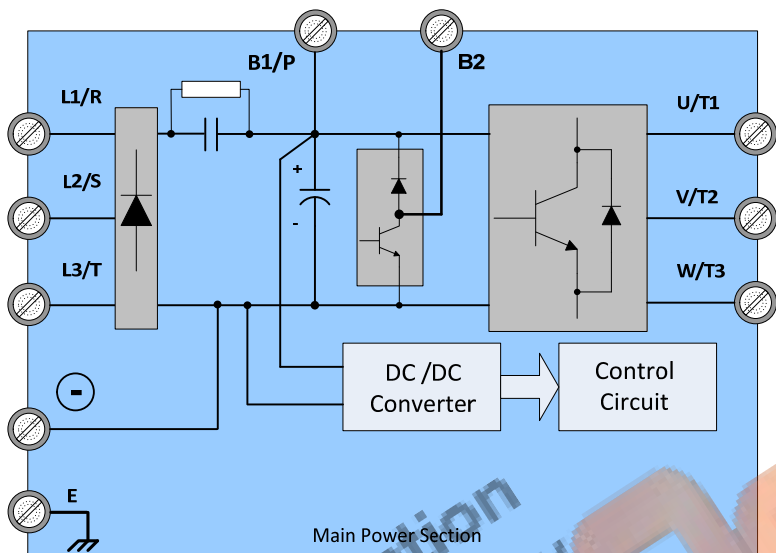

2: 200V: 2 ~ 25 HP / 400V: 3 ~ 30 HP

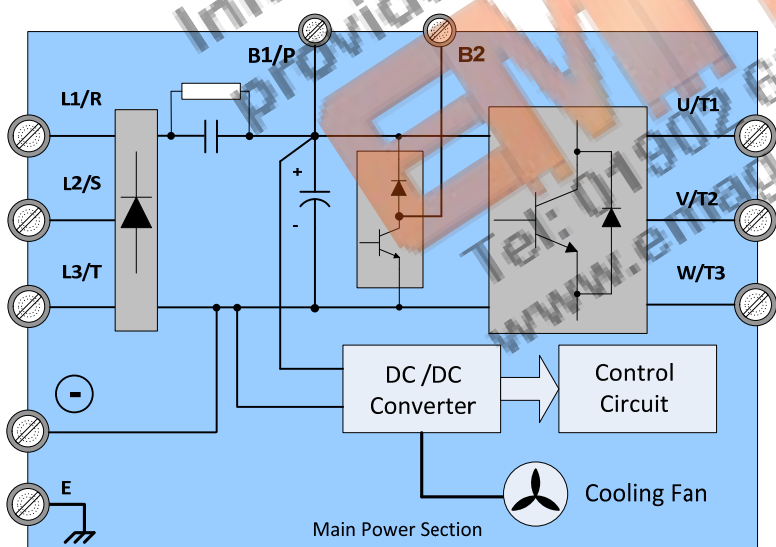

3: 200V: 30 ~ 40 HP / 400V: 40 ~ 60 HP

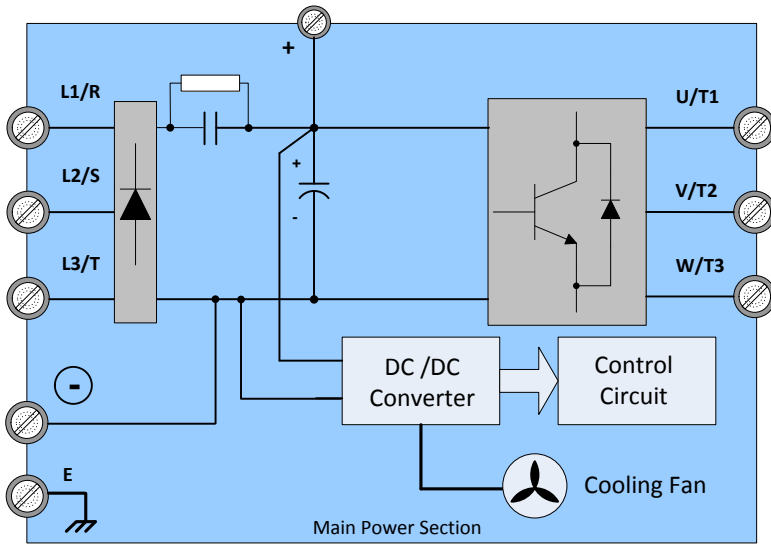

4: 200V: 50 ~ 60 HP / 400V: 75 ~ 100 HP

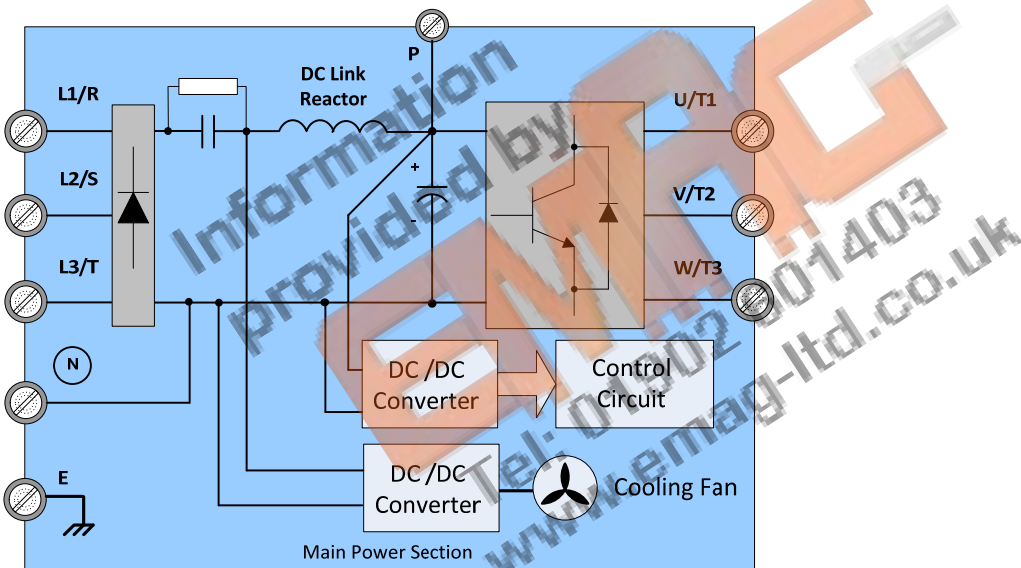

5: 200V: 75 ~ 100 HP

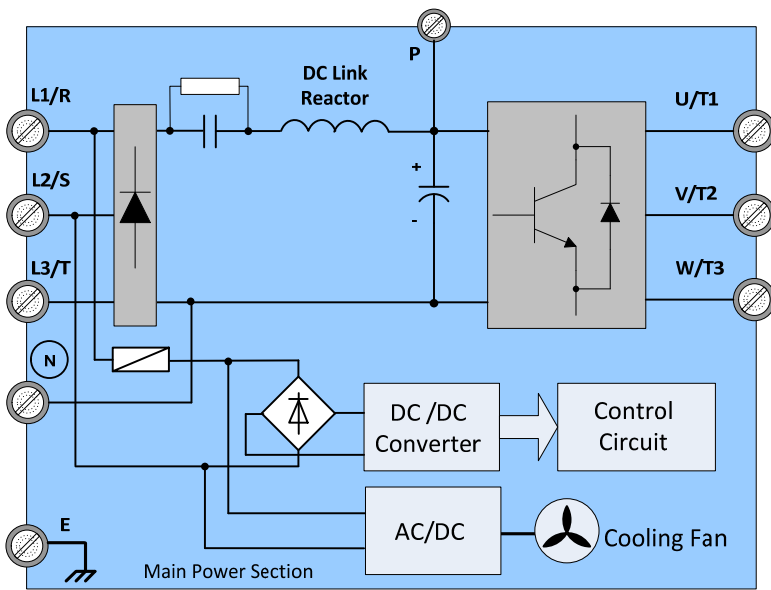

6: 400V: 125 ~ 215 HP

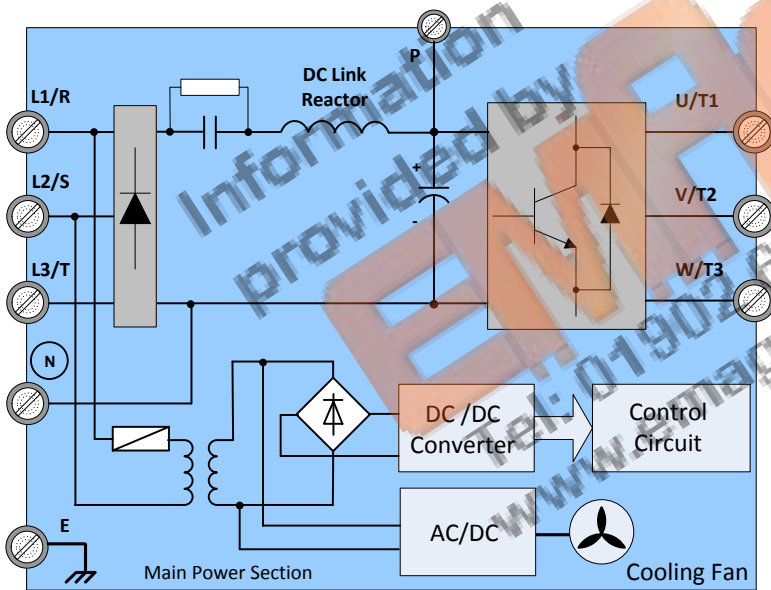

7: 200V: 125 ~ 150 HP

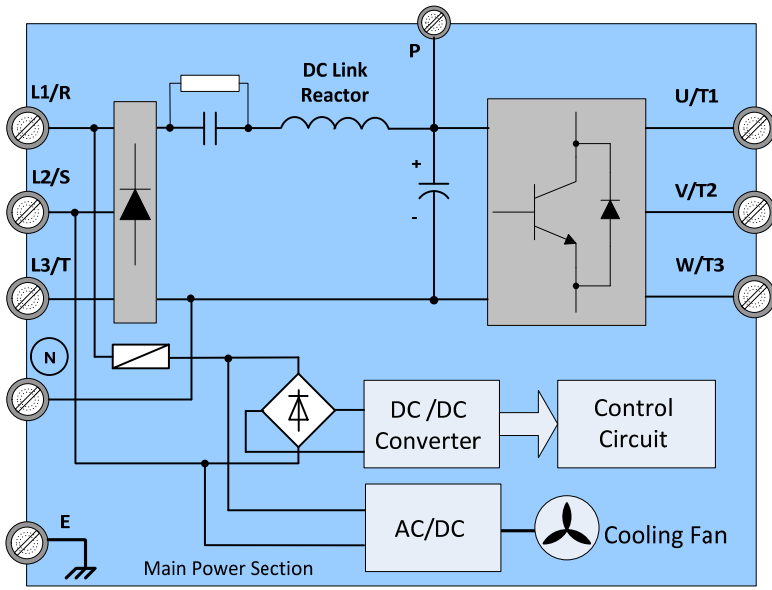

8: 400V: 250 ~ 425 HP

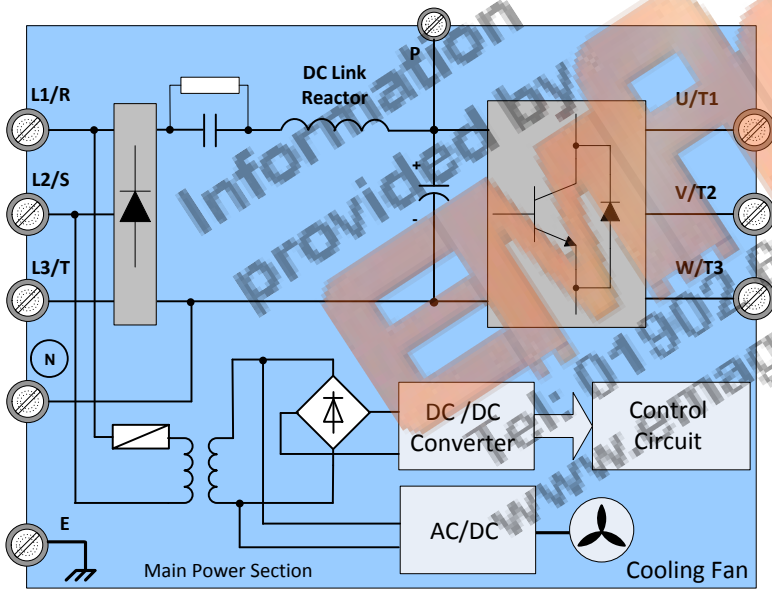

3.11.1 Cooling Fan Supply Voltage Selection (400V class)

The inverter input voltage range of the A510 400V class models ranges from 380 to 480Vac. In these models the cooling fan is directly powered from the power supply. Inverter models A510-4125/ 4150/ 4175/ 4215/ 4250/ 4300/ 4375/ 4425-C3 requires the user to select the correct jumper position based on the inverter input voltage ("440V" is the default position for these models). Please select the correct position according to the input voltage. If the voltage setting is too low, the cooling fan will not provide adequate cooling for the inverter resulting in an over-heat error. If the input voltage is greater than 460Vac, select the "460V" position.

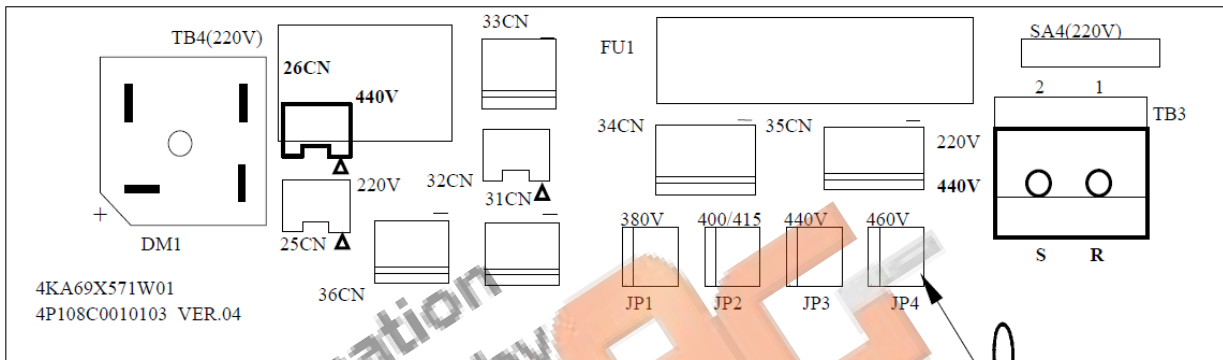

A510-4125~4215 model

For example, input voltage is 460 Vac, jumper pin needs to put in "460V" position.

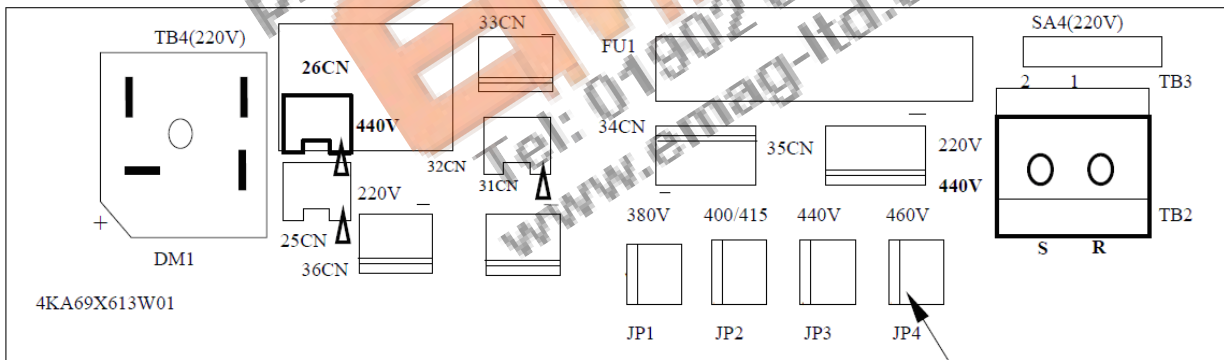
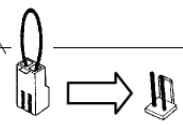

A510-4250~4425 model

For example, input voltage is 460 Vac, jumper pin needs to put in "460V" position.

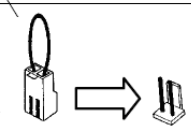

3.12 Inverter Wiring

Wiring Precautions

! Danger

- Do **NOT** remove any protective covers or attempt any wiring while input power is applied. Connect all wiring before applying input power. When making wiring changes after power up, remove input power and wait a minimum of five minutes after power has been turned off before starting. Also confirm that the charge lamp is off and that DC voltage between terminals B1/P or (+) and (-) does not exceed 25V, otherwise **electric shock may result**.
- Only authorized personnel should work on the equipment. (Take off metal jewelry such as watches and rings and use insulated tools.), otherwise **electric shock or injury may result**.

(A) Power input terminals

1. The Input power supply voltage can be connected in any phase sequence to power input terminals R/L1, S/L2, or T/L3 on the terminal block.
2. DO NOT connect the AC input power source to the output terminals U/T1, V/T2 and W/T3.
3. Connect the output terminals U/T1, V/T2, W/T3 to motor lead wires U/T1, V/T2, and W/T3, respectively.
4. Check that the motor rotates forward with the forward run source. If it does not, swap any 2 of the output cables to change motor direction.
5. DO NOT connect phase correcting capacitors or LC/RC noise filter to the output circuit.

(B) Grounding

1. Connect the ground terminal (E) to ground having a resistance of less than 100Ω.
2. Do not share the ground wire with other devices, such as welding machines or power tools.
3. Always use a ground wire that complies with the local codes and standards for electrical equipment and minimize the length of ground wire.
4. When using more than one inverter, be careful not to loop the ground wire, as shown below in Fig. 3.12.1.

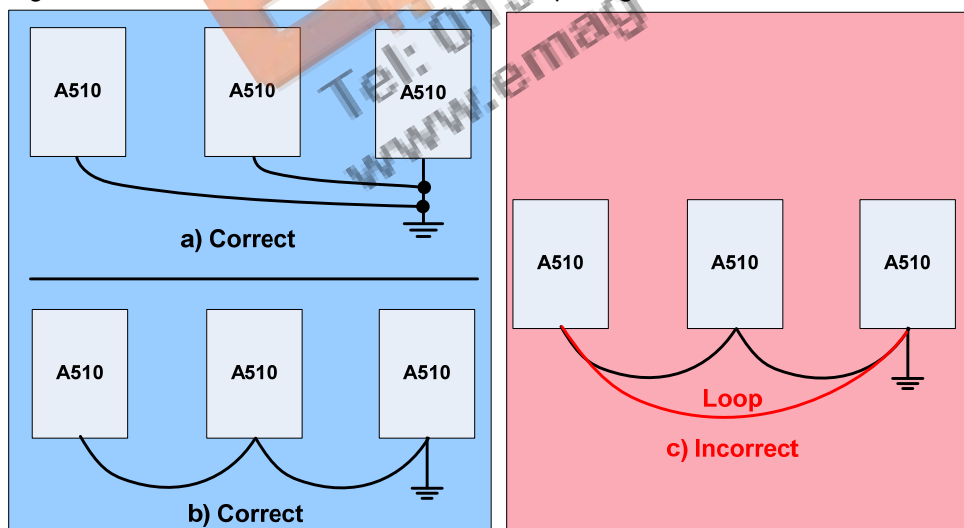

Fig. 3.12.1 Inverter Grounding

3.13 Input Power and Motor Cable Length

The length of the cables between the input power source and /or the motor and inverter can cause a significant phase to phase voltage reduction due to the voltage drop across the cables. The wire size shown in Tables 3.16.1 is based on a maximum voltage drop of 2%. If this value is exceeded, a wire size having larger diameter may be needed. To calculate phase to phase voltage drop, apply the following formula:

$$\text{Phase-to-phase voltage drop (V)} = \sqrt{3} \times \text{resistance of wire } (\Omega/\text{km}) \times \text{length of line (m)} \times \text{current} \times 10^{-3}$$

(km=3280 x feet)

(m=3.28 x feet)

3.14 Cable Length vs. Carrier Frequency

The allowable setting of the PWM carrier frequency is also determined by motor cable length and is specified in the following Table 3.14.1.

Table 3.14.1 Cable Length vs. Carrier Frequency

Cable length between the inverter and Motor in m (ft.).	< 30m (100)	30 – 50 (100 – 165)	50 – 100 (166 - 328)	≥ 100 (329)
Recommended carrier frequency allowed Parameter 11-01	16kHz (max)	10 kHz (max)	5 kHz (max)	2 kHz (max)

3.15 Installing an AC Line Reactor

If the inverter is connected to a large-capacity power source (600kVA or more), install an optional AC reactor on the input side of the inverter. This also improves the power factor on the power supply side.

3.16 Power Input Wire Size, NFB and MCB Part Numbers

The following table shows the recommended wire size, molded case circuit breakers and magnetic contactors for each of the A510 models. It depends on the application whether or not to install a circuit breaker. The NFB must be installed between the input power supply and the inverter input (R/L1, S/L2, T/L3).

Note: When using a ground protection make sure the current setting is above 200mA and trip delay time is 0.1 sec of higher.

Table 3.16.1 Wiring instrument for 200V/400V class

Power	A510 Model			wire diameter (mm ²)			NFB ^{*4}	MC ^{*4}
	horse power (HP) ^{*1}	Rated KVA HD/ND	Rated current (A) HD/ND	Main circuit ^{*2}	Grounding line E(G)	Control line ^{*3}		
200V 1 Ø / 3 Ø	1HP	1.9/2.3	5/6	2~5.5	2~5.5	0.5~2	TO-50EC(15A)	CU-11
	2HP	3/3.7	8/9.6	2~5.5	3.5~5.5	0.5~2	TO-50EC(20A)	CU-11
	3HP	4.2/4.6	11/12	3.5~5.5	3.5~5.5	0.5~2	TO-50EC(30A)	CU-11
200V 3 Ø	5.4HP	6.7/8.0	17.5/21	5.5	5.5	0.5~2	TO-50EC(30A)	CU-16
	7.5HP	9.5/11.4	25/30	8	5.5~8	0.5~2	TO-100S(50A)	CU-18
	10HP	12.6/15.2	33/40	8	5.5~8	0.5~2	TO-100S(50A)	CU-25
	15HP	17.9/21.3	47/56	14	8	0.5~2	TO-100S(100A)	CU-50
	20HP	22.9/26.3	60/69	22	8	0.5~2	TO-100S(100A)	CU-65
	25HP	27.8/30.1	73/79	22	14	0.5~2	TO-225S(100A)	CU-80
	30HP	32.4/41.9	85/110	38	14	0.5~2	TO-225S(150A)	CN-100
	40HP	43.8/52.6	115/138	60	22	0.5~2	TO-225S(175A)	CN-125
	50HP	55.3/64.4	145/169	80	22	0.5~2	TO-225S(200A)	CN-150
	60HP	68.6/76.2	180/200	100	22	0.5~2	TO-225S(225A)	CN-180
	75HP	81.9/95.3	215/250	150	22	0.5~2	TO-400S(300A)	CN-300
	100HP	108/118.9	283/312	200	38	0.5~2	TO-400S(400A)	CN-300
	125HP	132/137.2	346/400	300	38	0.5~2	TO-400S(400A)	SK-400
150HP	158/172	415/450	250*2P	50	0.5~2	TO-800S(800A)	SK-600	
400V 3 Ø	1HP	2.6/3.1	3.4/4.1	2~5.5	2~5.5	0.5~2	TO-50EC(15A)	CU-11
	2HP	3.2/4.1	4.2/5.4	2~5.5	3.5~5.5	0.5~2	TO-50EC(15A)	CU-11
	3HP	4.2/5.3	5.5/6.9	2~5.5	3.5~5.5	0.5~2	TO-50EC(15A)	CU-11
	5.4HP	7/8.5	9.2/11.1	2~5.5	3.5~5.5	0.5~2	TO-50EC(15A)	CU-18
	7.5HP	11.3/13.3	14.8/17.5	3~5.5	3.5~5.5	0.5~2	TO-50EC(20A)	CU-18
	10HP	13.7/17.5	18/23	5.5	5.5	0.5~2	TO-50EC(30A)	CU-25
	15HP	18.3/23.6	24/31	8	8	0.5~2	TO-100S(50A)	CU-25
	20HP	23.6/29.0	31/38	8	8	0.5~2	TO-100S(50A)	CU-35
	25HP	29.7/33.5	39/44	8	8	0.5~2	TO-100S(50A)	CU-50
	30HP	34.3/44.2	45/58	14	8	0.5~2	TO-100S(75A)	CU-50
	40HP	45.7/54.9	60/72	22	8	0.5~2	TO-100S(100A)	CU-65
	50HP	57.2/67.1	75/88	22	14	0.5~2	TO-100S(100A)	CU-80
	60HP	69.3/78.5	91/103	38	14	0.5~2	TO-225S(150A)	CN-100
	75HP	89.9/111	118/145	60	22	0.5~2	TO-225S(175A)	CN-125
	100HP	114/126	150/165	80	22	0.5~2	TO-225S(225A)	CN-150
125HP	137/159	180/208	150	22	0.5~2	TO-400S(300A)	CN-300	
150HP	165/191	216/250	150	22	0.5~2	TO-400S(300A)	CN-300	

Power	A510 Model			wire diameter (mm ²)			NFB ^{*4}	MC ^{*4}
	horse power (HP) ^{*1}	Rated KVA HD/ND	Rated current (A) HD/ND	Main circuit ^{*2}	Grounding line E(G)	Control line ^{*3}		
	175HP	198/226	260/296	200	30	0.5~2	TO-400S(400A)	CN-300
	215HP	225/250	295/328	250	30	0.5~2	TO-400S(400A)	CN-300
	250HP	282/332	370/435	300	38	0.5~2	TO-400S(400A)	SK-400
	300HP	343/393	450/515	250*2P	50	0.5~2	TO-800S(800A)	SK-600 (800A)
	375HP	400/446	523/585	250*2P	50	0.5~2	TE-1000(1000A)	SK-600 (800A)
	425HP	461/461	585/585	250*2P	50	0.5~2	TE-1000(1000A)	SK-600 (800A)

*1: Constant torque rating.

*2: The main circuit terminals R/L1, S/L2, T/L3, U/T1, V/T2, W/T3, B1 / P, B2, P, N

*3: Control line is the terminal wire on the control board.

*4: The NFB and MCB listed in the table are of TECO product numbers, products with same rated specification of other brands may be used. To reduce electrical noise interference, ensure that a RC surge absorber (R: 10Ω/5W, C: 0.1μf/1000VDC) is added to both sides of MCB coil.

Information provided by
EMAG
 Tel: 01902 601403
 www.emag-ltd.co.uk

3.17 Control Circuit Wiring

- (1) Separate the wiring for control circuit terminals from main circuit wiring for terminals (R/L1, S/L2, T/L3, U/T1, V/T2, W/T3).
- (2) Separate the wiring for control circuit terminals R1A-R1B-R1C (or R2A, R2C) (Relay outputs) from wiring for terminals ① - ⑧, A01, A02, GND, DO1, DO2, DOG, +12V, (-12V), A11, A12 and GND wiring.
- (3) Use shielded twisted-pair cables (#24 - #14 AWG / 0.5 -2 mm²) shown in Fig. 3.17.1 for control circuits to minimize noise problems. The maximum wiring distance should not exceed 50m (165 ft).

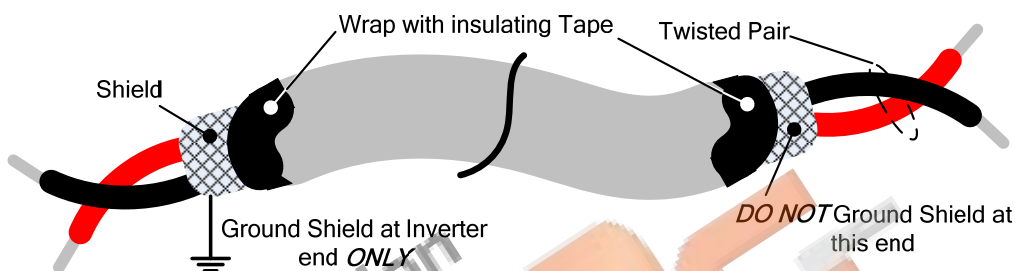

Fig. 3.17.1 Shielded Twisted-Pair

- (4) When the digital multi-function output terminals (DO1, DO2) are connected to an external relay, a freewheeling diode should be connected across the relay coil to prevent an inductive voltage spike from damaging the output circuitry as shown in Fig. 3.17.2 below.

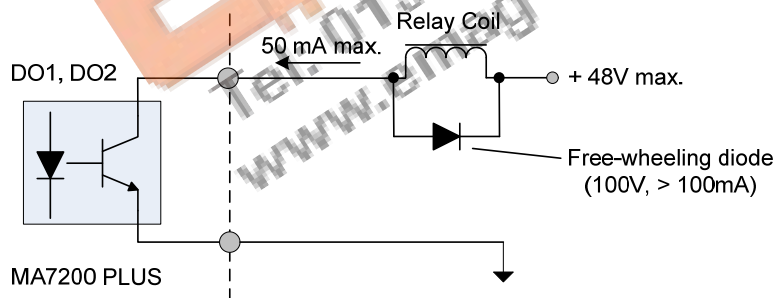

Fig. 3.17.2 Photo-Coupler Connected to an External Relay

(5) In Section 3.8 the control boards referenced have a jumper SW3 that can select the digital input to terminals ① - ③ to be set for SINK or SOURCE. The following Fig. 3.17.3 (a.) – (d.) shows examples for the various SINK / Source interfaces.

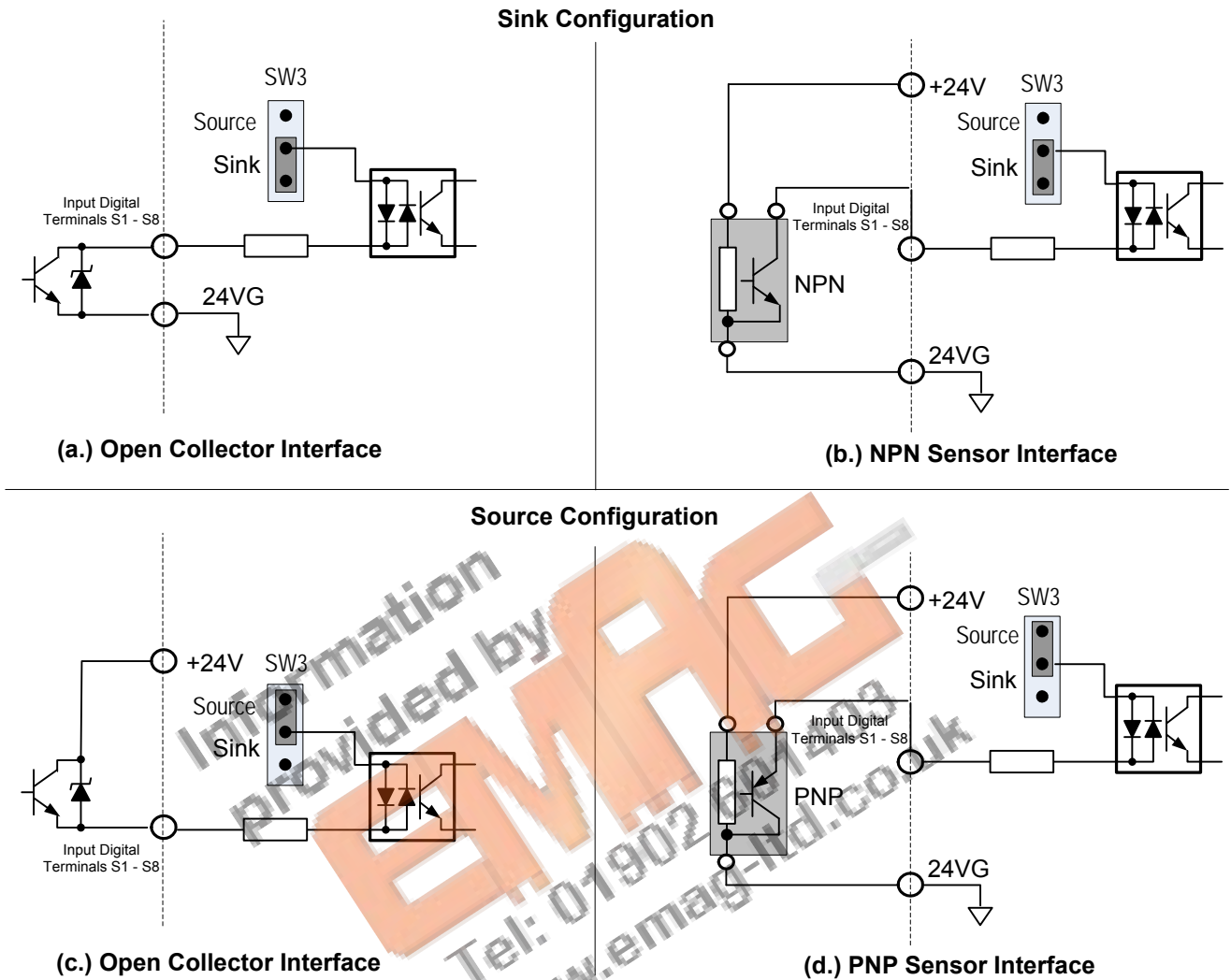

Fig. 3.17.3 Sink / Source Configurations

3.18 Inverter Specifications

Basic Specifications 200V class

Inverter capacity (HP)		1	2	3	5	7.5	10	15	20	25	
Output rated	Heavy Duty type H.D. (150%/1min)	Rated output Capacity (KVA)	1.9	3	4.2	6.7	9.5	12.6	17.9	22.9	27.8
		Rated output current (A)	5	8	11	17.5	25	33	47	60	73
		Maximum applicable motor *1HP (KW)	1 (0.75)	2 (1.5)	3 (2.2)	5 (3.7)	7.5 (5.5)	10 (7.5)	15 (11)	20 (15)	25 (18.5)
	Normal Duty type N.D. (120%/1min)	Rated output Capacity (KVA)	2.3	3.7	4.6	8.0	11.4	15.2	21.3	26.3	30.1
		Rated output current (A)	6	9.6	12	21	30	40	56	69	79
		Maximum applicable motor *1HP (KW)	1.5 (1.1)	3 (2.2)	4 (3)	7.5 (5.5)	10 (7.5)	15 (11)	20 (15)	25 (18.5)	30 (22)
The maximum output voltage (V)		3-phase, 200V ~ 240V									
The maximum output frequency (Hz)		Based on parameter setting 0.1~400.0 (1200.0) Hz									
Power	Rated voltage, frequency		Single/3-phase 200V~240V, 50/60Hz			3-phase 200V~240V, 50/60Hz					
	Allowable voltage fluctuation		-15% ~ +10%								
	Allowable frequency fluctuation		±5%								

Inverter capacity (HP)		30	40	50	60	75	100	125	150		
Output rated	Heavy Duty type H.D. (150%/1min)	Rated output Capacity (KVA)	32.4	43.8	55.3	68.6	81.9	108	132	158	
		Rated output current (A)	85	115	145	180	215	283	346	415	
		Maximum applicable motor *1HP (KW)	30 (22)	40 (30)	50 (37)	60 (45)	75 (55)	100 (75)	125 (90)	150 (110)	
	Normal Duty type N.D. (120%/1min)	Rated output Capacity (KVA)	41.9	52.6	64.4	76.2	95.3	118.9	152.4	172	
		Rated output current (A)	110	138	169	200	250	312	400	450	
		Maximum applicable motor *1HP (KW)	40 (30)	50 (37)	60 (45)	75 (55)	100 (75)	125 (90)	150 (110)	175 (130)	
The maximum output voltage (V)		3-phase, 200V ~ 240V									
The maximum output frequency (Hz)		Based on parameter setting 0.1~400.0 (1200.0) Hz									
Power	Rated voltage, frequency		Single/3-phase 200V~240V, 50/60Hz			3-phase 200V~240V, 50/60Hz					
	Allowable voltage fluctuation		-15% ~ +10%								
	Allowable frequency fluctuation		±5%								

Basic Specifications 400V class

Inverter capacity (HP)		1	2	3	5	7.5	10	15	20	25	30	
Output rated	Heavy Duty type H.D. (150%/1min)	Rated output Capacity (KVA)	2.6	3.2	4.2	7	11.3	13.7	18.3	23.6	29.7	34.3
		Rated output current (A)	3.4	4.2	5.5	9.2	14.8	18	24	31	39	45
		Maximum applicable motor *1HP (KW)	1 (0.75)	2 (1.5)	3 (2.2)	5 (4)	7.5 (5.5)	10 (7.5)	15 (11)	20 (15)	25 (18.5)	30 (22)
	Normal Duty type N.D. (120%/1min)	Rated output Capacity (KVA)	3.1	4.1	5.3	8.5	13.3	17.5	23.6	29.0	33.5	44.2
		Rated output current (A)	4.1	5.4	6.9	11.1	17.5	23	31	38	44	58
		Maximum applicable motor *1HP (KW)	2 (1.5)	3 (2.2)	4 (3)	7.5 (5.5)	10 (7.5)	15 (11)	20 (15)	25 (18.5)	30 (22)	40 (30)
The maximum output voltage (V)		3-phase 380V~ 480V										
The maximum output frequency (Hz)		Based on parameter setting 0.1~400.0 (1200.0) Hz										
Power	Rated voltage, frequency		3-phase 380V ~ 480V, 50/60Hz									
	Allowable voltage fluctuation		-15% ~ +10%									
	Allowable frequency fluctuation		±5%									

Inverter capacity (HP)		40	50	60	75	100	125	150	175	215		
Output rated	Heavy Duty type H.D. (150%/1min)	Rated output Capacity (KVA)	45.7	57.2	69.3	89.9	114	137	165	198	225	
		Rated output current (A)	60	75	91	118	150	180	216	260	295	
		Maximum applicable motor *1HP (KW)	40 (30)	50 (37)	60 (45)	75 (55)	100 (75)	125 (90)	150 (110)	175 (132)	215 (160)	
	Normal Duty type N.D. (120%/1min)	Rated output Capacity (KVA)	54.9	67.1	78.5	111	126	159	191	226	250	
		Rated output current (A)	72	88	103	145	165	208	250	296	328	
		Maximum applicable motor *1HP (KW)	50 (37)	60 (45)	75 (55)	100 (75)	125 (90)	150 (110)	175 (132)	215 (160)	250 (185)	
The maximum output voltage (V)		3-phase 380V~480V										
The maximum output frequency (Hz)		Based on parameter setting 0.1~400.0 (1200.0) Hz										
Power	Rated voltage, frequency		3-phase 380V ~ 480V, 50/60Hz									
	Allowable voltage fluctuation		-15% ~ +10%									
	Allowable frequency fluctuation		±5%									

Inverter capacity (HP)			250	300	375	425
Output rated	Heavy Duty type H.D. (150%/1min)	Rated Output capacity (KVA)	282	343	400	461
		Rated output current (A)	370	450	523	585
		Maximum applicable motor *1HP (KW)	250 (185)	300 (220)	375 (280)	425 (315)
	Normal Duty type N.D. (120%/1min)	Rated Output capacity (KVA)	332	393	446	446
		Rated output current (A)	435	515	585	585
		Maximum applicable motor *1HP (KW)	270 (200)	335 (250)	425 (315)	425 (315)
The maximum output voltage (V)			3-phase 380V~480V			
The maximum output frequency (Hz)			Based on parameter setting 0.1~ 400.0 Hz			
Power	Rated voltage, frequency		3-phase 380V ~ 480V, 50/60Hz			
	Allowable voltage fluctuation		-15% ~ +10%			
	Allowable frequency fluctuation		±5%			

*1: Take standard 4-pole induction motor as the base.

*2: A510 model is designed to use in heavy duty conditions, the factory setting is the HD (Heavy Duty type) mode.

*3: The overload capacity of A510 model HD (Heavy Duty) is 150% / 1min, 200% / 2sec. See the table below for the carrier frequency default setting and range.

*4: The overload capacity of A510 model ND (Normal Duty) is 120%/1min, carrier range: 2 KHz ~ 16 KHz, the default setting is 2 KHz.

*5: If it is greater than default carrier frequency, you need to adjust the load current based on the de-rating curve.

Inverter Voltage and Capacity		HD mode	HD mode
200V class	400V class	carrier frequency range	carrier frequency factory setting
1~20HP	1~30HP	2~16KHz	8KHz
25HP	-	2~12KHz	6KHz
30~40HP	40~50HP	2~12KHz (*6)	5KHz
50~100HP	60~175HP	2~10KHz (*6)	5KHz
-	215HP	2~8KHz	3KHz
125~150HP		2~5KHz	5KHz
	250-375HP	2~5KHz	4KHz
	425HP	2~5KHz	2KHz

*6: If control mode (00-00) is set to 2 (SLV mode) and maximum frequency (01-02) is larger than 80Hz, the carrier frequency range is 2~8 KHz.

The following table shows maximum output frequency for each control mode.

Duty Cycle	Control mode	Other settings	Maximum output frequency
Heavy Duty (00-27=0)	V/F V/F + PG	maximum frequency set to 400Hz (00-31 = 0)	400Hz
		maximum frequency set to 1200Hz (00-31 = 1)	1200Hz
	SLV	200V 1~10HP, 400V 1~15HP	150Hz
		200V 15~25HP, 400V 20HP	110Hz
		400V 25~30HP	100Hz
		200V 30~150HP, 400V 40~425HP, carrier (11-01) is set as 8K or below 8K	100Hz
		200V 30~100HP, 400V 40~175HP, carrier (11-01) is above 8K	80Hz
	SV	unlimited	400Hz
PMSV	unlimited	400Hz	
Normal Duty (00-27=1)	V/F V/F + PG	maximum frequency set to 400Hz (00-31 = 0)	120Hz
		maximum frequency set to 1200Hz (00-31 = 1)	1200Hz

Information provided by
EMAG
 Tel: 01902 601403
www.emag-ltd.co.uk

General Specifications

Control characteristics	Operation mode	LCD keypad with parameter copy function (Optional Seven-segment display * 5 + LED keypad)
	Control mode	V/F, V/F+PG, SLV, SV, PMSV, PMSLV* with space vector PWM mode
	Frequency control range	0.1Hz~400.0Hz(1200.0Hz)
	Frequency accuracy (Temperature change)	Digital references: $\pm 0.01\%$ (-10 to +40°C) Analog references: $\pm 0.1\%$ (25°C $\pm 10^\circ\text{C}$)
	Speed control accuracy	$\pm 0.1\%$ (vector control(SV)), $\pm 0.5\%$ (vector control / open-loop)
	Frequency setting resolution	Digital references: 0.01Hz, Analog references: 0.06Hz/60Hz
	Output frequency resolution	0.01Hz
	Inverter overload	Rated output current 150%/1 min, 200%/2sec (HD mode),120%/1 min (ND mode) Factory 150%/1 min, 200%/2sec
	Frequency setting signal	0 to +10VDC / 4 to 20mA or -10V to +10VDC and pulse input command frequency
	Acceleration / deceleration time	0.0 - 6000.0 second (separately set acceleration and deceleration time)
	Voltage, frequency characteristics	Custom V/f curve based on parameters
	Braking torque	+/- 20%
	Protection functions	Main control functions
Other functions		Accumulated power-on / run time, 4 sets of fault history records and latest fault record state, energy-saving function setting, single phase protection, smart braking, DC braking, Dwell, S curve acceleration and deceleration, Up / Down operation, MODBUS protocol, pulse output, engineering units, SINK / SOURCE digital inputs.
Stall protection		Stall prevention level can be set independently in acceleration, deceleration and constant speed.
Instantaneous over current (OC) and output short-circuit (SC) protection		Inverter stops when the output current exceeds 200% of the inverter rated current.
Inverter overload Protection (OL2)		HD mode: If inverter rated current 150%/1 min., or 200%/2sec is exceeded inverter stops, factory default carrier frequency setting is 8~2KHz. ND mode: If inverter rated current 120%/1 min is exceeded inverter stops , factory default carrier frequency is 2KHz.
Motor overload (OL1) protection		Electrical overload protection curve I ² T
Over voltage(OV) protection		If the main circuit DC voltage rises over 410V (200V class) / 820V (400V class), the motor stops running.
Under voltage (UV)		If the main circuit DC voltage falls below 190V (200V class) / 380V (400V class), the motor stops running.
Automatic restart after instantaneous power fault		Power fault exceeds 15ms. Automatic restart function available after instantaneous power fault in 2sec.
Overheat protection(OH)		Uses temperature sensor for protection.
Ground Fault protection(GF)		Use current sensor for protection.
DC bus charge indicator		When main circuit DC voltage $\geq 50\text{V}$, the CHARGE LED turns on.
Output Phase Loss Protection (OPL)		If the OPL is detected the motor stops automatically.

* PMSLV is under development.

Environment Specification	Location	Indoor (protected from corrosive gases and dust).
	Ambient temperature	-10~+40°C (14°F~104°F) (IP20/NEMA1), -10~+50°C (14°F~122°F) (IP00)) without de-rating; with de-rating, its maximum operation temperature is 60°C (140°F)
	Storage temperature	-20~+70°C (-4°F~+158°F)
	Humidity	95%RH or less (no condensation)
	Altitude and vibration	Altitude of 1000m (3181ft) or below, .5.9m/s2(0.6G)
Communication function		RS-485 standard (MODBUS RTU / ASCII protocol) (RJ45)
PLC function		Built-in
EMI protection		The built-in noise filter complies with EN61800-3 available for inverters 400V 215HP or below.
EMS protection		EN61800-3
Certification	CE	EN61800-3 (CE & RE) EN61800-5-1 (LVD)
	UL	UL508C
Option		Open collector/line driver /PM encoder feedback card

Information provided by
EMAG
 Tel: 01902 601403
www.emag-ltd.co.uk

3.19 Inverter Derating Based on Carrier Frequency

200V Models

1 - 20 HP

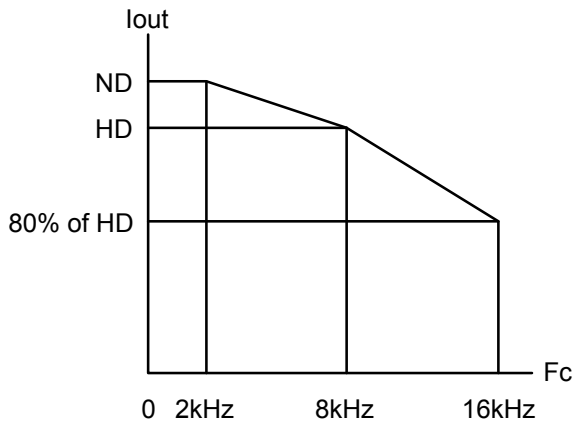

25 HP

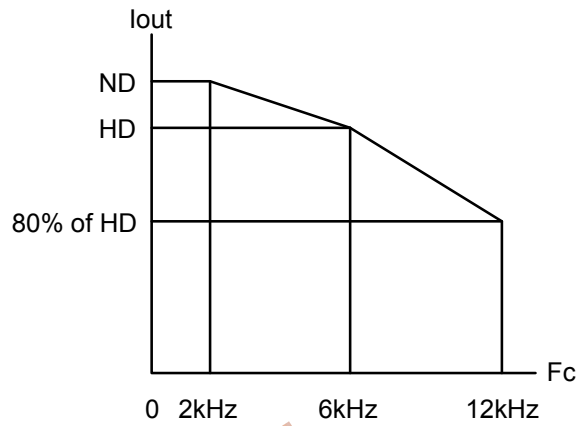

30 - 40 HP

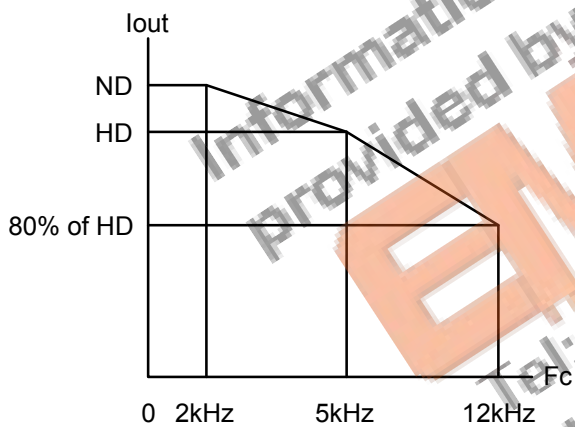

50 - 100 HP

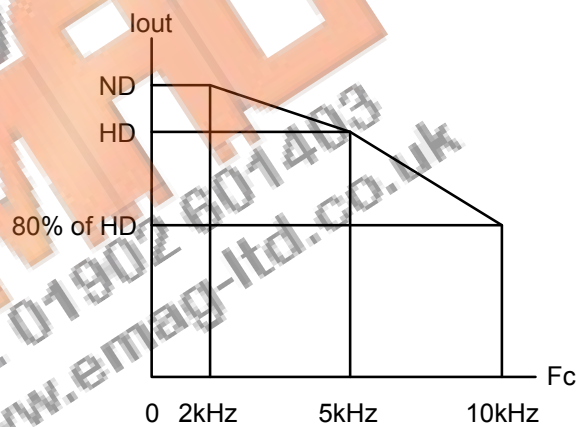

125 - 150 HP

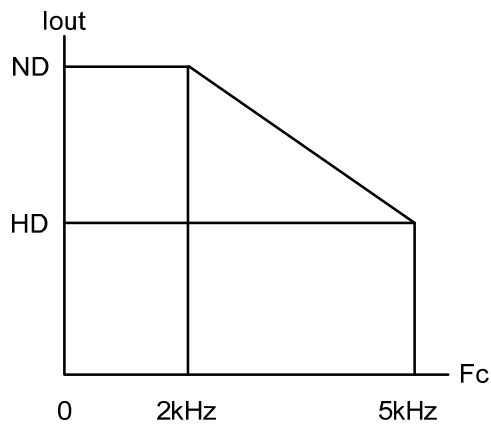

400V Models

1 - 30 HP

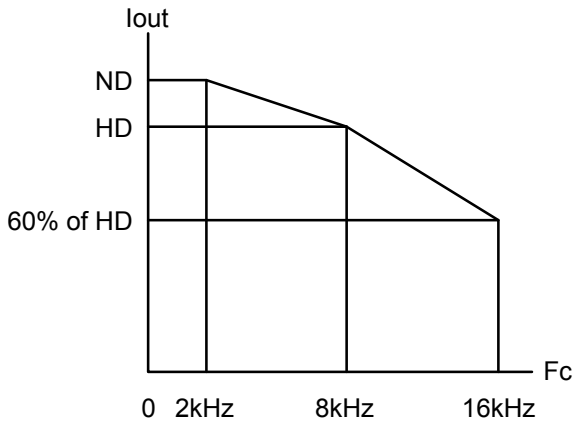

40 - 50 HP

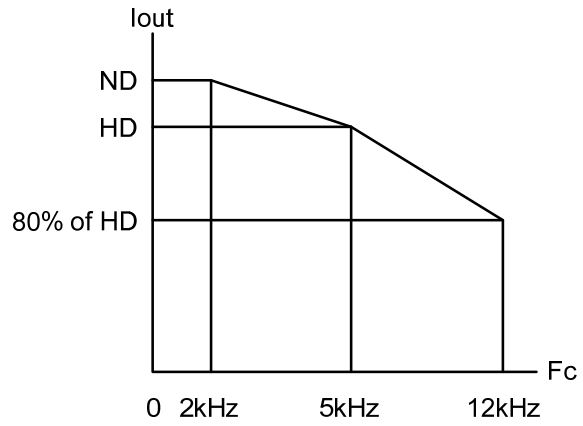

60 - 175 HP

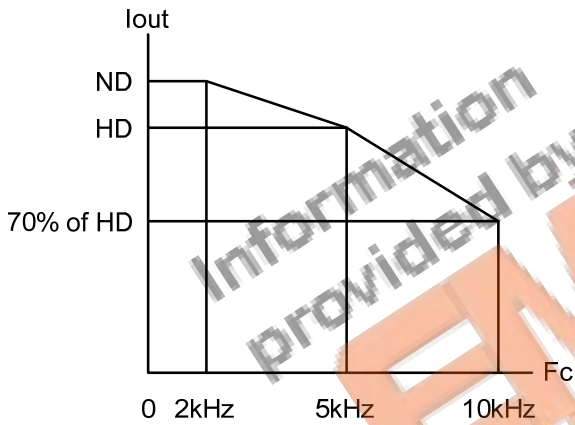

125 - 150 HP

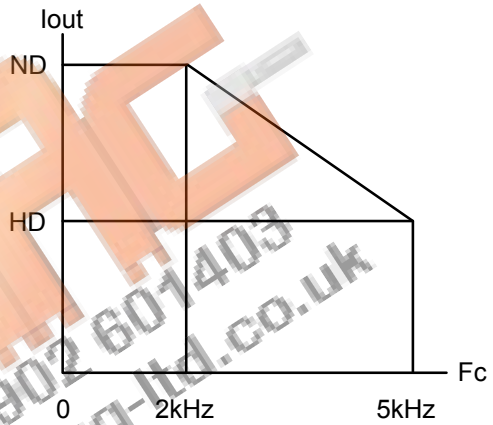

215 HP

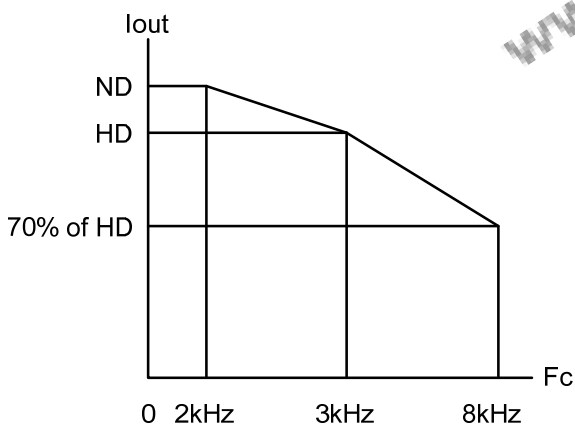

250 - 375 HP

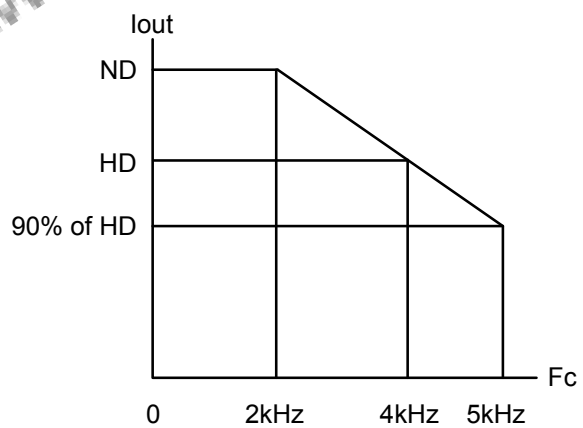

425 HP

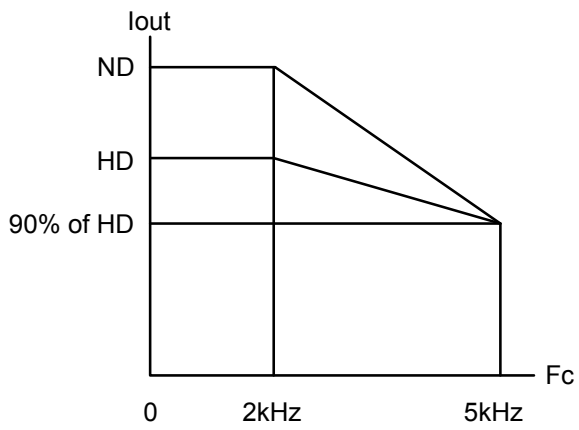

3.20 Inverter Derating Based on Temperature

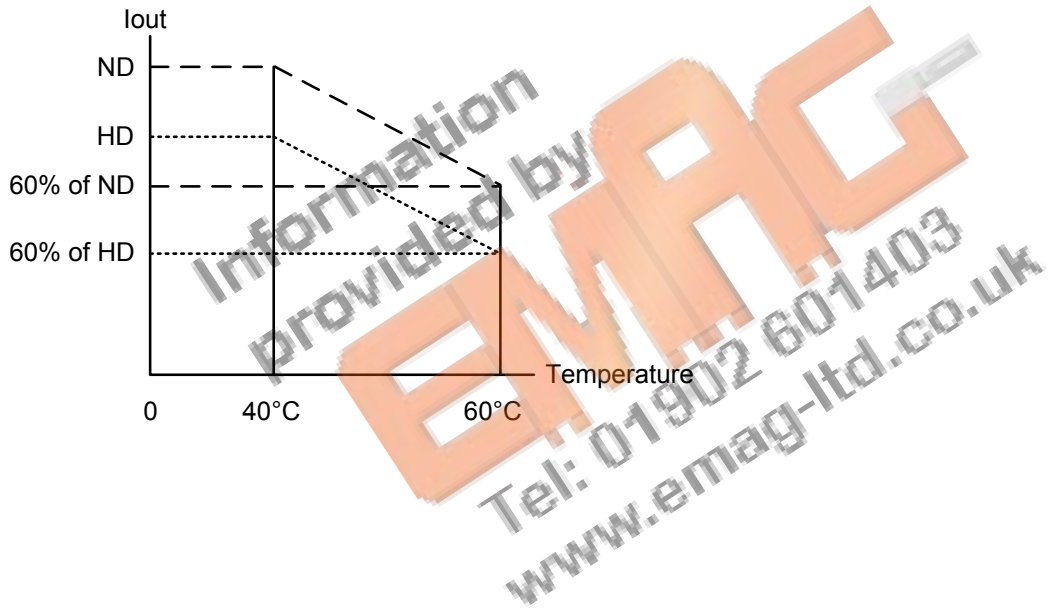

3.21 Inverter Dimensions

(a) 200V: 1 - 5HP / 400V: 1 - 7.5HP (IP20/NEMA1)

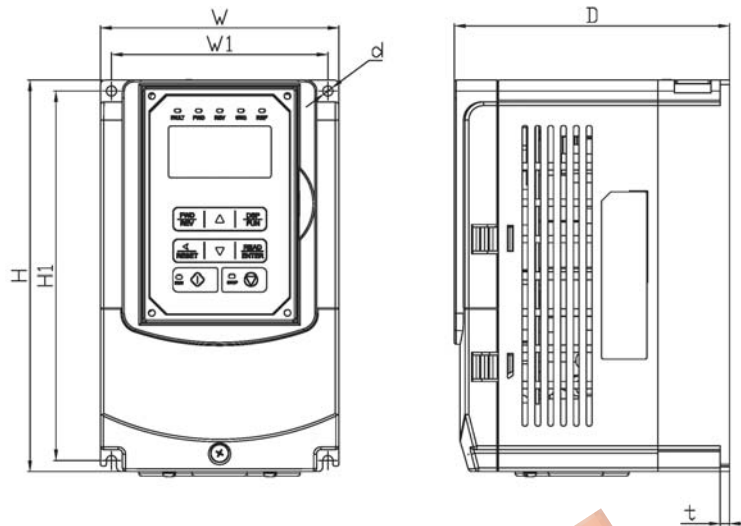

Inverter Model	Dimensions in mm (inch)							Net Weight in kg (lbs)
	W	H	D	W1	H1	t	d	
A510-2001-H	130 (5.12)	215 (8.46)	150 (5.91)	118 (4.65)	203 (7.99)	5 (0.20)	M5	2.5 (5.5)
A510-2002-H	130 (5.12)	215 (8.46)	150 (5.91)	118 (4.65)	203 (7.99)	5 (0.20)	M5	2.5 (5.5)
A510-2003-H	140 (5.51)	279 (10.98)	177 (6.97)	122 (4.80)	267 (10.51)	7 (0.28)	M6	4.0 (8.8)
A510-2005-H3	140 (5.51)	279 (10.98)	177 (6.97)	122 (4.80)	267 (10.51)	7 (0.28)	M6	4.0 (8.8)
A510-4001-H3	130 (5.12)	215 (8.46)	150 (5.91)	118 (4.65)	203 (7.99)	5 (0.20)	M5	2.5 (5.5)
A510-4002-H3	130 (5.12)	215 (8.46)	150 (5.91)	118 (4.65)	203 (7.99)	5 (0.20)	M5	2.5 (5.5)
A510-4003-H3	130 (5.12)	215 (8.46)	150 (5.91)	118 (4.65)	203 (7.99)	5 (0.20)	M5	2.5 (5.5)
A510-4005-H3	140 (5.51)	279 (10.98)	177 (6.97)	122 (4.80)	267 (10.51)	7 (0.28)	M6	4.0 (8.8)
A510-4008-H3	140 (5.51)	279 (10.98)	177 (6.97)	122 (4.80)	267 (10.51)	7 (0.28)	M6	4.0 (8.8)

(b) 200V: 7.5 - 25HP / 400V: 10 - 30HP (IP20/NEMA1)

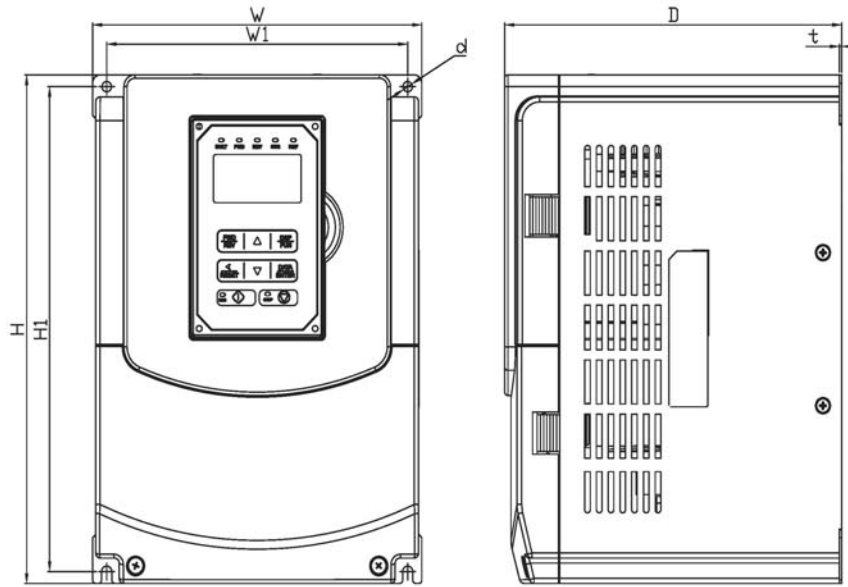

Inverter Model	Dimensions in mm (inch)							Net Weight in kg (lbs)
	W	H	D	W1	H1	t	d	
A510-2008-H3	210 (8.27)	300 (11.81)	215 (8.46)	192 (7.56)	286 (11.26)	1.6 (0.06)	M6	6.2 (13.67)
A510-2010-H3	210 (8.27)	300 (11.81)	215 (8.46)	192 (7.56)	286 (11.26)	1.6 (0.06)	M6	6.2 (13.67)
A510-2015-H3	265 (10.43)	360 (14.17)	225 (8.86)	245 (9.65)	340 (13.39)	1.6 (0.06)	M8	10 (22.05)
A510-2020-H3	265 (10.43)	360 (14.17)	225 (8.86)	245 (9.65)	340 (13.39)	1.6 (0.06)	M8	10 (22.05)
A510-2025-H3	265 (10.43)	360 (14.17)	225 (8.86)	245 (9.65)	340 (13.39)	1.6 (0.06)	M8	10 (22.05)
A510-4010-H3	210 (8.27)	300 (11.81)	215 (8.46)	192 (7.56)	286 (11.26)	1.6 (0.06)	M6	6.2 (13.67)
A510-4015-H3	210 (8.27)	300 (11.81)	215 (8.46)	192 (7.56)	286 (11.26)	1.6 (0.06)	M6	6.2 (13.67)
A510-4020-H3	265 (10.43)	360 (14.17)	225 (8.86)	245 (9.65)	340 (13.39)	1.6 (0.06)	M8	10 (22.05)
A510-4025-H3	265 (10.43)	360 (14.17)	225 (8.86)	245 (9.65)	340 (13.39)	1.6 (0.06)	M8	10 (22.05)
A510-4030-H3	265 (10.43)	360 (14.17)	225 (8.86)	245 (9.65)	340 (13.39)	1.6 (0.06)	M8	10 (22.05)

(c) 200V: 30 - 40HP / 400V: 40 - 60HP (IP20/NEMA1)

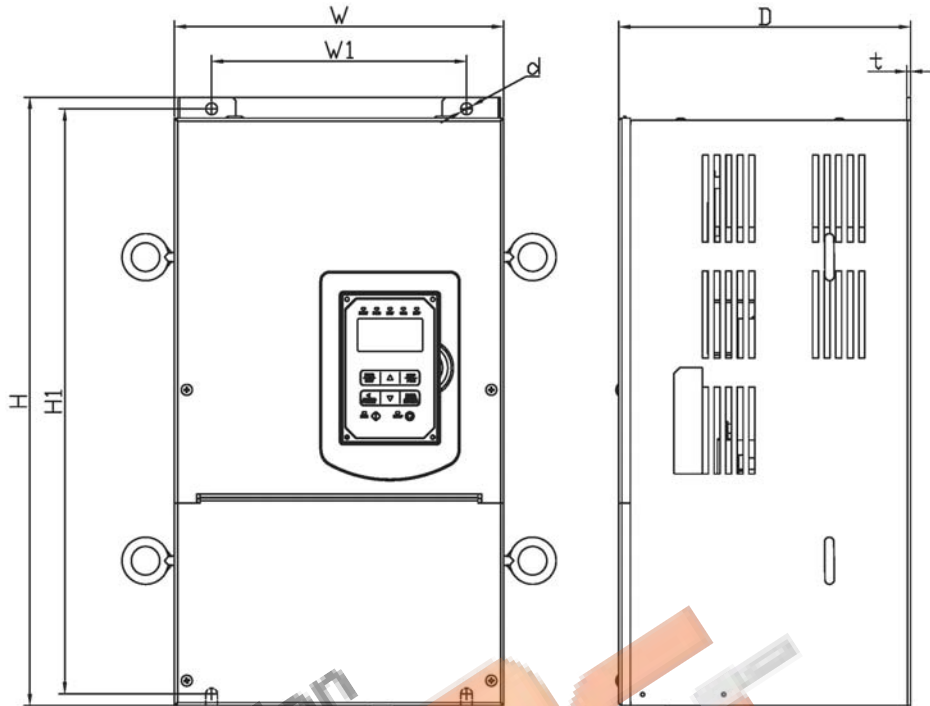

Inverter Model	Dimensions in mm (inch)							Net Weight in kg (lbs)
	W	H	D	W1	H1	t	d	
A510-2030-H3	284 (11.18)	525 (20.67)	252 (9.92)	220 (8.66)	505 (19.88)	3.3 (0.13)	M8	30 (66.14)
A510-2040-H3	284 (11.18)	525 (20.67)	252 (9.92)	220 (8.66)	505 (19.88)	3.3 (0.13)	M8	30 (66.14)
A510-4040-H3	284 (11.18)	525 (20.67)	252 (9.92)	220 (8.66)	505 (19.88)	3.3 (0.13)	M8	30 (66.14)
A510-4050-H3	284 (11.18)	525 (20.67)	252 (9.92)	220 (8.66)	505 (19.88)	3.3 (0.13)	M8	30 (66.14)
A510-4060-H3	284 (11.18)	525 (20.67)	252 (9.92)	220 (8.66)	505 (19.88)	3.3 (0.13)	M8	30 (66.14)

(d) 200V: 50 - 100HP / 400V: 75 - 215HP (IP00)

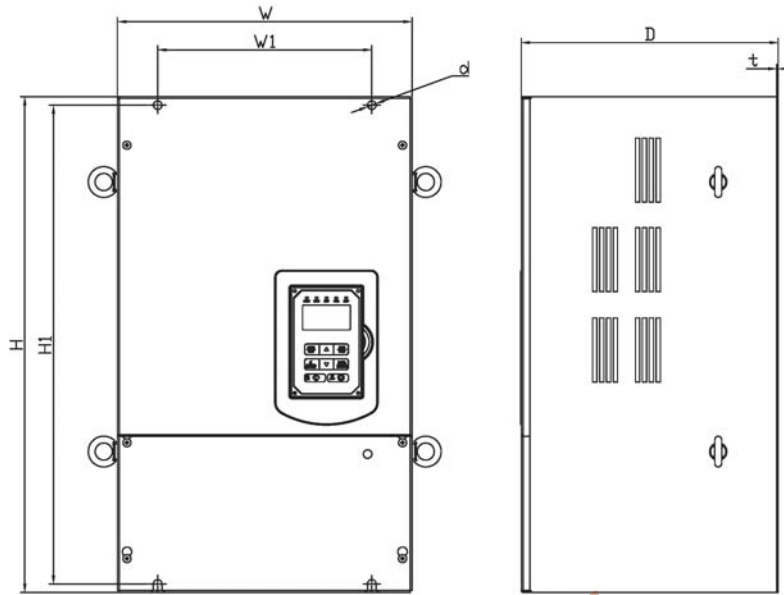

Inverter Model	Dimensions in mm (inch)							Net Weight in kg (lbs)
	W	H	D	W1	H1	t	d	
A510-2050-H3	344 (13.54)	580 (22.83)	300 (11.81)	250 (9.84)	560 (22.05)	1.6 (0.06)	M10	40.5 (89.29)
A510-2060-H3	344 (13.54)	580 (22.83)	300 (11.81)	250 (9.84)	560 (22.05)	1.6 (0.06)	M10	40.5 (89.29)
A510-2075-H3	459 (18.08)	790 (31.10)	324.5 (12.78)	320 (12.60)	760 (29.92)	1.6 (0.06)	M10	74 (163.14)
A510-2100-H3	459 (18.08)	790 (31.10)	324.5 (12.78)	320 (12.60)	760 (29.92)	1.6 (0.06)	M10	74 (163.14)
A510-4075-H3	344 (13.54)	580 (22.83)	300 (11.81)	250 (9.84)	560 (22.05)	1.6 (0.06)	M10	40.5 (89.29)
A510-4100-H3	344 (13.54)	580 (22.83)	300 (11.81)	250 (9.84)	560 (22.05)	1.6 (0.06)	M10	40.5 (89.29)
A510-4125-H3	459 (18.08)	790 (31.10)	324.5 (12.78)	320 (12.60)	760 (29.92)	1.6 (0.06)	M10	74 (163.14)
A510-4150-H3	459 (18.08)	790 (31.10)	324.5 (12.78)	320 (12.60)	760 (29.92)	1.6 (0.06)	M10	74 (163.14)
A510-4175-H3	459 (18.08)	790 (31.10)	324.5 (12.78)	320 (12.60)	760 (29.92)	1.6 (0.06)	M10	74 (163.14)
A510-4215-H3	459 (18.08)	790 (31.10)	324.5 (12.78)	320 (12.60)	760 (29.92)	1.6 (0.06)	M10	74 (163.14)

(e) 200V: 50 - 100HP / 400V: 75 - 215HP (IP20/ NEMA1)

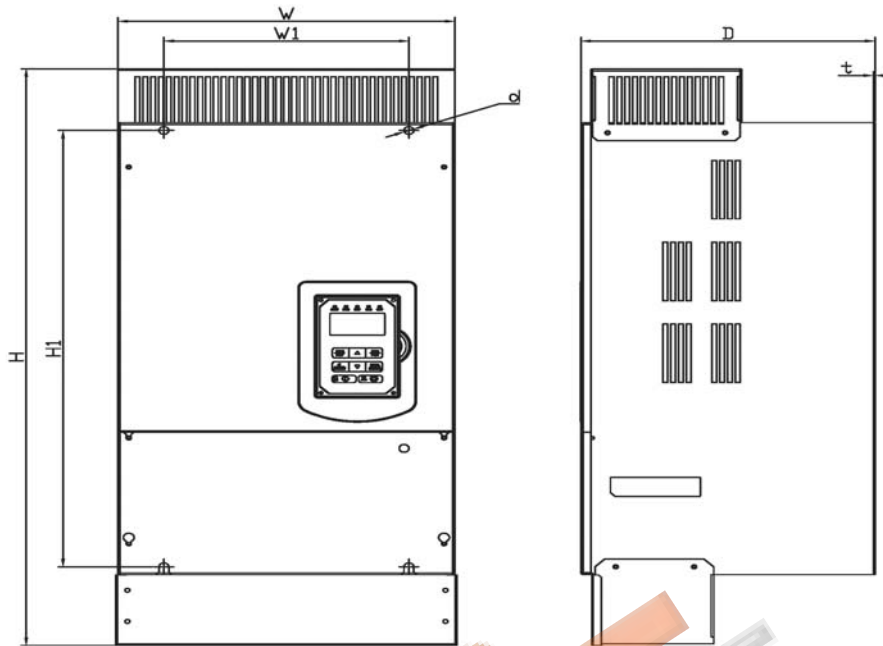

Inverter Model	Dimensions in mm (inch)							Net Weight in kg (lbs)
	W	H	D	W1	H1	t	d	
A510-2050-H3	348.5 (13.72)	740 (29.13)	300 (11.81)	250 (9.84)	560 (22.05)	1.6 (0.06)	M10	44 (97)
A510-2060-H3	348.5 (13.72)	740 (29.13)	300 (11.81)	250 (9.84)	560 (22.05)	1.6 (0.06)	M10	44 (97)
A510-2075-H3	463.5 (18.25)	1105 (43.50)	324.5 (12.78)	320 (12.60)	760 (29.92)	1.6 (0.06)	M10	81 (178.57)
A510-2100-H3	463.5 (18.25)	1105 (43.50)	324.5 (12.78)	320 (12.60)	760 (29.92)	1.6 (0.06)	M10	81 (178.57)
A510-4075-H3	348.5 (13.72)	740 (29.13)	300 (11.81)	250 (9.84)	560 (22.05)	1.6 (0.06)	M10	44 (97)
A510-4100-H3	348.5 (13.72)	740 (29.13)	300 (11.81)	250 (9.84)	560 (22.05)	1.6 (0.06)	M10	44 (97)
A510-4125-H3	463.5 (18.25)	1105 (43.50)	324.5 (12.78)	320 (12.60)	760 (29.92)	1.6 (0.06)	M10	81 (178.57)
A510-4150-H3	463.5 (18.25)	1105 (43.50)	324.5 (12.78)	320 (12.60)	760 (29.92)	1.6 (0.06)	M10	81 (178.57)
A510-4175-H3	463.5 (18.25)	1105 (43.50)	324.5 (12.78)	320 (12.60)	760 (29.92)	1.6 (0.06)	M10	81 (178.57)
A510-4215-H3	463.5 (18.25)	1105 (43.50)	324.5 (12.78)	320 (12.60)	760 (29.92)	1.6 (0.06)	M10	81 (178.57)

(f) 200V: 125 - 150HP / 400V: 250 - 425HP (IP00)

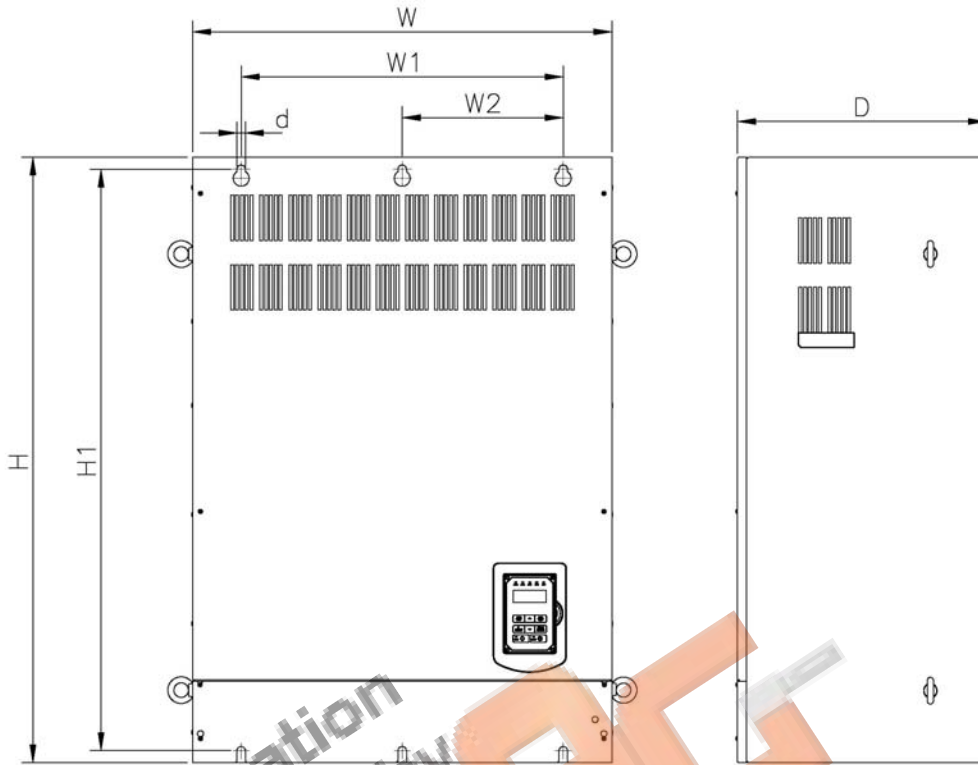

Inverter Model	Dimensions in mm (inch)								Net Weight in kg (lbs)
	W	H	D	W1	W2	H1	t	d	
A510-2125-H3	690 (27.16)	1000 (39.37)	410 (16.14)	530 (20.87)	265 (10.43)	960 (37.80)	1.6 (0.06)	M12	184 (405.65)
A510-2150-H3	690 (27.16)	1000 (39.37)	410 (16.14)	530 (20.87)	265 (10.43)	960 (37.80)	1.6 (0.06)	M12	184 (405.65)
A510-4250-H3	690 (27.16)	1000 (39.37)	410 (16.14)	530 (20.87)	265 (10.43)	960 (37.80)	1.6 (0.06)	M12	184 (405.65)
A510-4300-H3	690 (27.16)	1000 (39.37)	410 (16.14)	530 (20.87)	265 (10.43)	960 (37.80)	1.6 (0.06)	M12	184 (405.65)
A510-4375-H3	690 (27.16)	1000 (39.37)	410 (16.14)	530 (20.87)	265 (10.43)	960 (37.80)	1.6 (0.06)	M12	184 (405.65)
A510-4425-H3	690 (27.16)	1000 (39.37)	410 (16.14)	530 (20.87)	265 (10.43)	960 (37.80)	1.6 (0.06)	M12	184 (405.65)

(g) 200V: 125 - 150HP / 400V: 250 - 425HP (IP20/NEMA1)

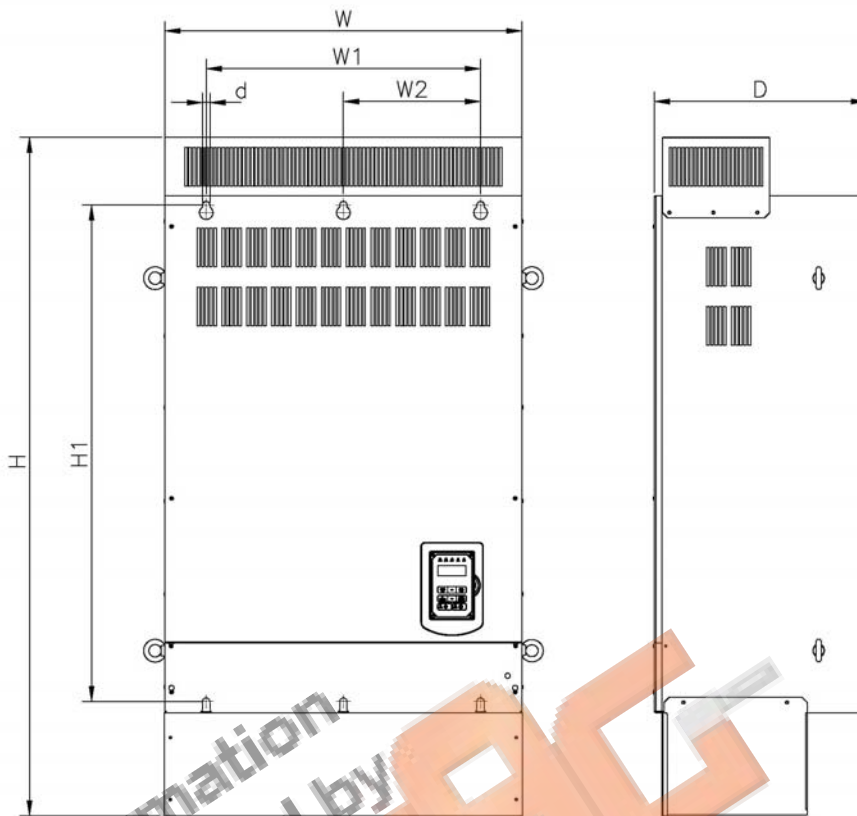

Inverter Model	Dimensions in mm (inch)								Net Weight in kg (lbs)
	W	H	D	W1	W2	H1	t	d	
A510-2125-H3	690 (27.16)	1313 (51.69)	410 (16.14)	530 (20.87)	265 (10.43)	960 (37.80)	1.6 (0.06)	M12	194 (427.70)
A510-2150-H3	690 (27.16)	1313 (51.69)	410 (16.14)	530 (20.87)	265 (10.43)	960 (37.80)	1.6 (0.06)	M12	194 (427.70)
A510-4250-H3	690 (27.16)	1313 (51.69)	410 (16.14)	530 (20.87)	265 (10.43)	960 (37.80)	1.6 (0.06)	M12	194 (427.70)
A510-4300-H3	690 (27.16)	1313 (51.69)	410 (16.14)	530 (20.87)	265 (10.43)	960 (37.80)	1.6 (0.06)	M12	194 (427.70)
A510-4375-H3	690 (27.16)	1313 (51.69)	410 (16.14)	530 (20.87)	265 (10.43)	960 (37.80)	1.6 (0.06)	M12	194 (427.70)
A510-4425-H3	690 (27.16)	1313 (51.69)	410 (16.14)	530 (20.87)	265 (10.43)	960 (37.80)	1.6 (0.06)	M12	194 (427.70)

3.22 Dimensions for Models with Built-in Filter

(a) 400V: 1 - 7.5HP

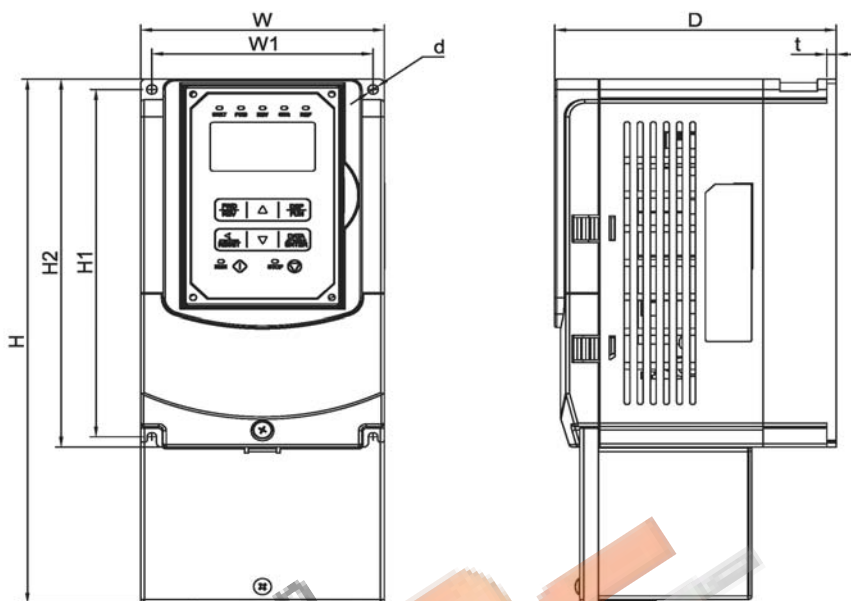

Inverter Model	Dimensions in mm (inch)								Net Weight in kg (lbs)
	W	H	D	W1	H1	H2	t	d	
A510-4001-H3F	130 (5.12)	306 (12.05)	150 (5.91)	118 (4.65)	203 (7.99)	215 (8.46)	5	M5	3.5 (7.71)
A510-4002-H3F	130 (5.12)	306 (12.05)	150 (5.91)	118 (4.65)	203 (7.99)	215 (8.46)	5	M5	3.5 (7.71)
A510-4003-H3F	130 (5.12)	306 (12.05)	150 (5.91)	118 (4.65)	203 (7.99)	215 (8.46)	5	M5	3.5 (7.71)
A510-4005-H3F	140 (5.51)	400 (15.75)	177 (6.97)	122 (4.80)	267 (10.51)	279 (10.98)	7	M6	5.5 (12.13)
A510-4008-H3F	140 (5.51)	400 (15.75)	177 (6.97)	122 (4.80)	267 (10.51)	279 (10.98)	7	M6	5.5 (12.13)

(b) 400V: 10 - 30HP

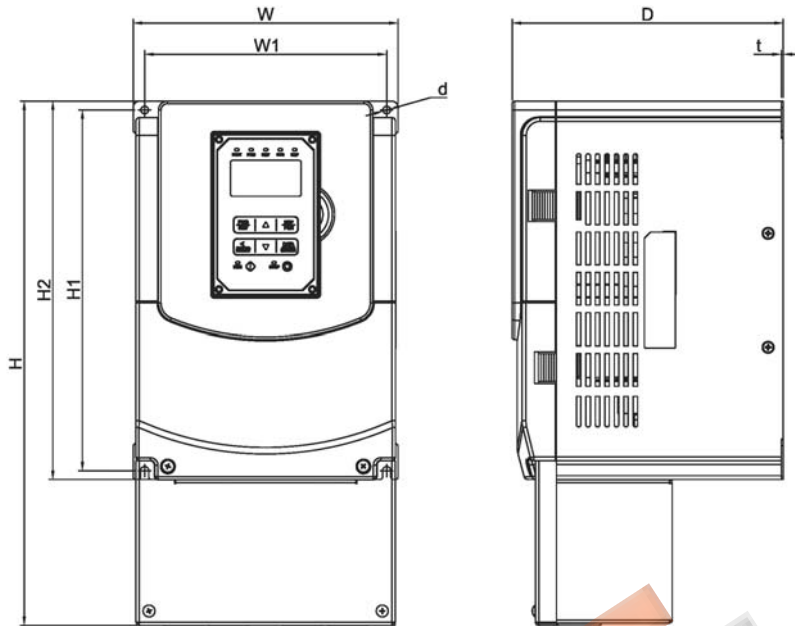

Inverter Model	Dimensions in mm (inch)								Net Weight in kg (lbs)
	W	H	D	W1	H1	H2	t	d	
A510-4010-H3F	210 (8.27)	416.5 (16.40)	215 (8.46)	192 (7.56)	286 (11.26)	300 (11.81)	1.6 (0.06)	M6	8.0 (17.63)
A510-4015-H3F	210 (8.27)	416.5 (16.40)	215 (8.46)	192 (7.56)	286 (11.26)	300 (11.81)	1.6 (0.06)	M6	8.0 (17.63)
A510-4020-H3F	265 (10.43)	500 (19.69)	225 (8.86)	245 (9.65)	340 (13.39)	360 (14.17)	1.6 (0.06)	M8	12.5 (27.56)
A510-4025-H3F	265 (10.43)	500 (19.69)	225 (8.86)	245 (9.65)	340 (13.39)	360 (14.17)	1.6 (0.06)	M8	12.5 (27.56)
A510-4030-H3F	265 (10.43)	500 (19.69)	225 (8.86)	245 (9.65)	340 (13.39)	360 (14.17)	1.6 (0.06)	M8	12.5 (27.56)

(c) 400V: 40 - 60HP

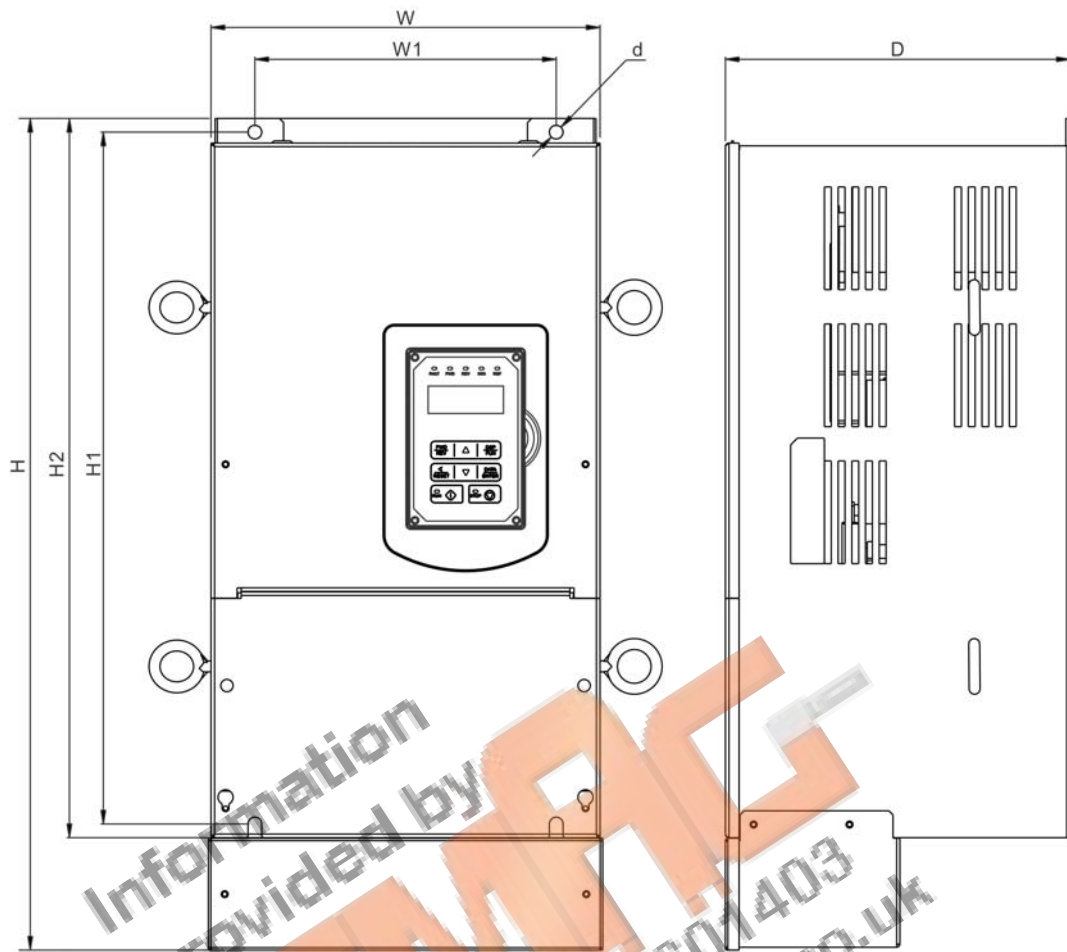

Inverter Model	Dimensions in mm (inch)							d	Net Weight in kg (lbs)
	W	H	D	W1	H1	H2	t		
A510-4040-H3F	284 (11.18)	679 (26.73)	252 (9.92)	220 (8.66)	505 (19.88)	525 (20.67)	3.3 (0.13)	M8	32.5 (71.65)
A510-4050-H3F	284 (11.18)	679 (26.73)	252 (9.92)	220 (8.66)	505 (19.88)	525 (20.67)	3.3 (0.13)	M8	32.5 (71.65)
A510-4060-H3F	284 (11.18)	679 (26.73)	252 (9.92)	220 (8.66)	505 (19.88)	525 (20.67)	3.3 (0.13)	M8	32.5 (71.65)

Chapter 4 Keypad and Programming Functions

4.1 LED Keypad

4.1.1 Keypad Display and Keys



DISPLAY	Description
5 Digit LED Display	Monitor inverter signals, view / edit parameters, fault / alarm display.
LED INDICATORS	
FAULT	LED ON when a fault or alarm is active.
FWD	LED ON when inverter is running in forward direction, flashing when stopping.
REV	On when inverter is running in reverse direction, flashing when stopping.
SEQ	LED ON when RUN command is from the external control terminals or from serial communication
REF	LED ON when Frequency Reference command is from the external control terminals or from serial communication

KEYS (8)	Description
RUN	RUN Inverter in Local Mode
STOP	STOP Inverter
▲	Parameter navigation Up, Increase parameter or reference value
▼	Parameter navigation down, decrease parameter or reference value
FWD/REV	Used to switch between Forward and Reverse direction
DSP/FUN	Used to scroll to next screen Frequency screen →Function selection→Monitor parameter
◀ / RESET	Selects active seven segment digit for editing with the ▲▼ keys Used to reset fault condition.
READ / ENTER	Used to read and save the value of the active parameter

Auto-Repeat Keys

Holding the ▲UP or ▼DOWN key for a longer period of time will initiate the auto-repeat function resulting in the value of the selected digit to automatically increase or decrease.

4.1.2 Seven Segment Display Description









Actual	LED Display	Actual	LED Display	Actual	LED Display	Actual	LED Display
0		A		L		Y	
1		B		n		-	
2		C		o		°	
3		D		P		_	
4		E		q		.	
5		F		r			
6		G		S			
7		H		t			
8		I		u			
9		J		v			

Display output frequency LED lights on	Frequency Reference LED flashes	Set Frequency Reference Flashing digit

- ◆ At power-up, the display will show the frequency reference setting and all LEDs are flashing. Press the ▲ (UP) or ▼ (DOWN) key to enter the frequency reference edit mode, use the ◀/RESET key to select which digit to edit (flashing). Use the ▲ (UP) or ▼ (DOWN) key to modify the value and press the READ / ENTER key to save the frequency reference and switch back to the frequency reference display mode.
- ◆ During run operation, the display will show the output frequency.

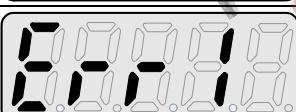

Note: When in edit mode and the READ / ENTER is not pressed within 5 sec, the inverter will switch back to the frequency reference display mode.

LED Display Examples



Seven Segment Display	Description
	1. Displays the frequency reference at power-up. 2. Displays the actual output frequency during run operation.
	Displays parameter code.
	Displays the setting value of parameter.
	Displays input voltage.
	Displays inverter current.
	Displays DC Bus Voltage.
	Displays temperature.
	Displays PID feedback value; The displayed digit is set by 12-01.
	Error display; refer to chapter 5 Troubleshooting and Maintenance.
	Displays AI1/ AI2 input (0~100%)

4.1.3 LED Indicator Description



- **Fault LED**

State	Description	FAULT LED
Off	No Fault Active	
Illuminated	Fault Active	



- **Forward LED**

State	Description	FWD LED
Off	Inverter in reverse direction	
Illuminated	Inverter is running in forward direction	
Flashing	Forward direction active, no run command	



- **Reverse LED**

State	Description	REV LED
Off	Inverter in forward direction	
Illuminated	Inverter is running in reverse direction	
Flashing	Reverse direction active, no run command	



- **RUN LED**

State	Description	RUN LED
Off	Inverter stopped	
Illuminated	Inverter running	
Flashing	Inverter stopped or stopping	

● SEQ LED

State	Description	SEQ LED
Off	Sequence controlled from keypad	
Illuminated	Sequence set from external source	

● REF LED

State	Description	REF LED
Off	Frequency reference set from keypad	
Illuminated	Frequency reference set from external source	

Run / Stop Status Indicators

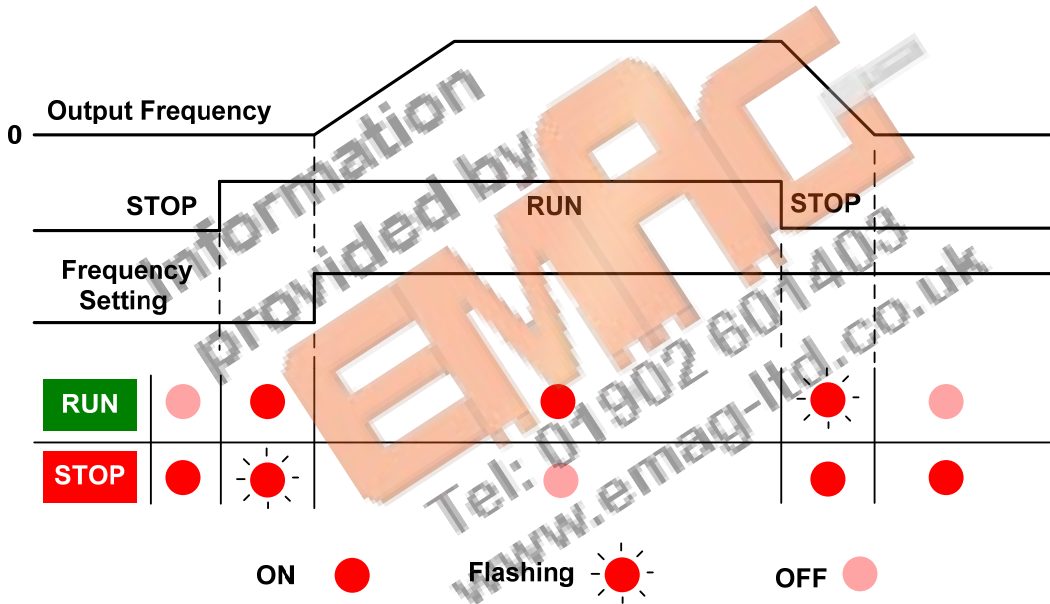

4.1.4 Power-up Monitor

◆ Power-up

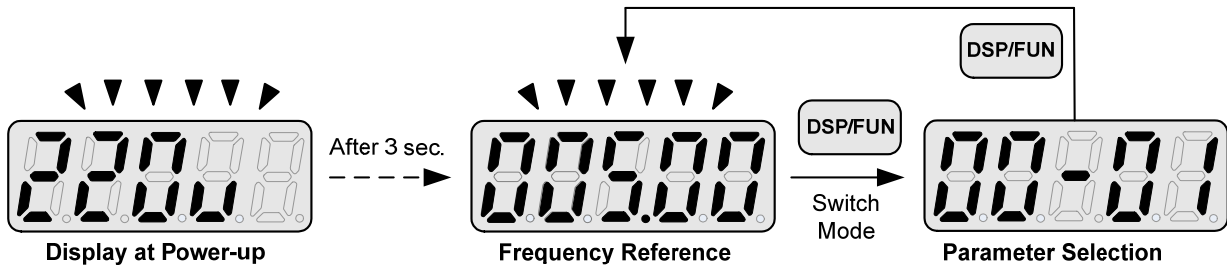

◆ Changing Monitor at Power-up

12- 00	Display Selection							
Range	Highest bit -> 0 0 0 0 0 <- Lowest bit The setting range for each bit is 0 ~ 7 from the highest bit to the lowest bit.							
	<table border="0"> <tr> <td>0: No display</td> <td>4: Temperature</td> </tr> <tr> <td>1: Output current</td> <td>5: PID feedback</td> </tr> <tr> <td>2: Output voltage</td> <td>6: AI1 value</td> </tr> <tr> <td>3: DC voltage</td> <td>7: AI2 value</td> </tr> </table>	0: No display	4: Temperature	1: Output current	5: PID feedback	2: Output voltage	6: AI1 value	3: DC voltage
0: No display	4: Temperature							
1: Output current	5: PID feedback							
2: Output voltage	6: AI1 value							
3: DC voltage	7: AI2 value							

Example: 12- 00= 【10000】

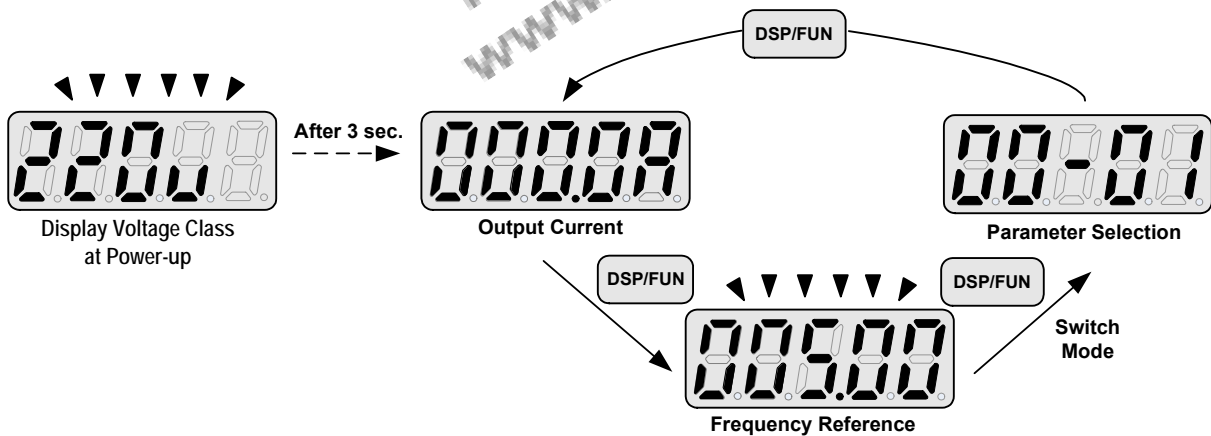

Example: 12- 00= 【12345】

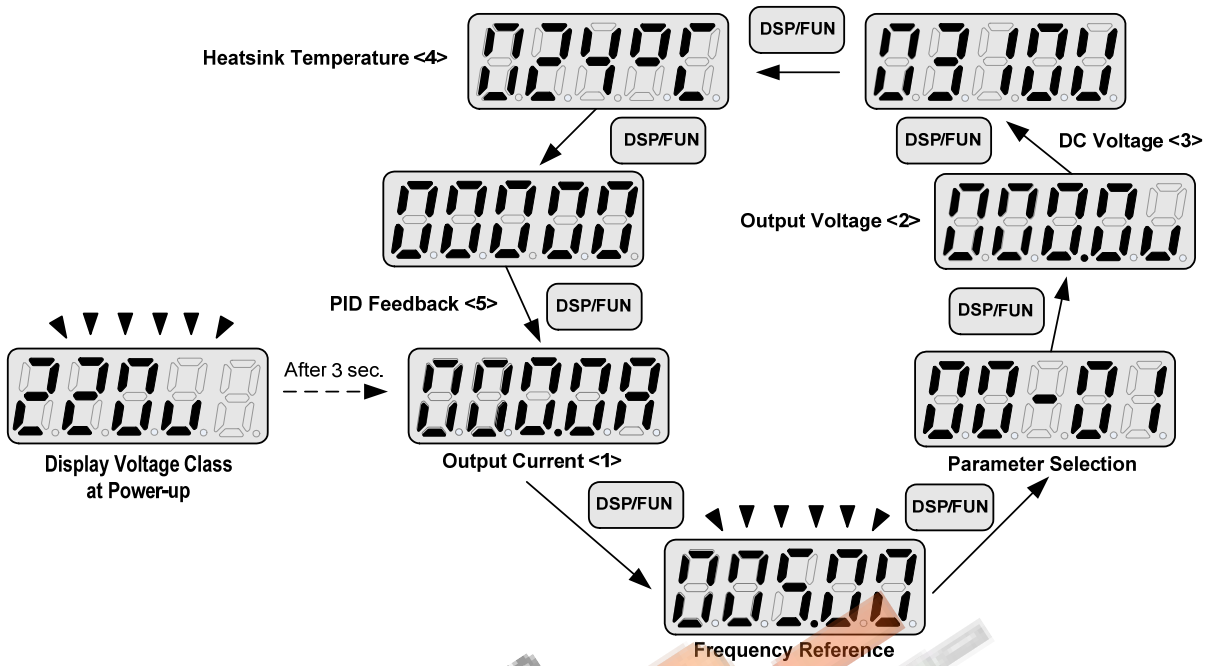

4.1.5 Modifying Parameters/ Set Frequency Reference

Example: Modifying Parameters

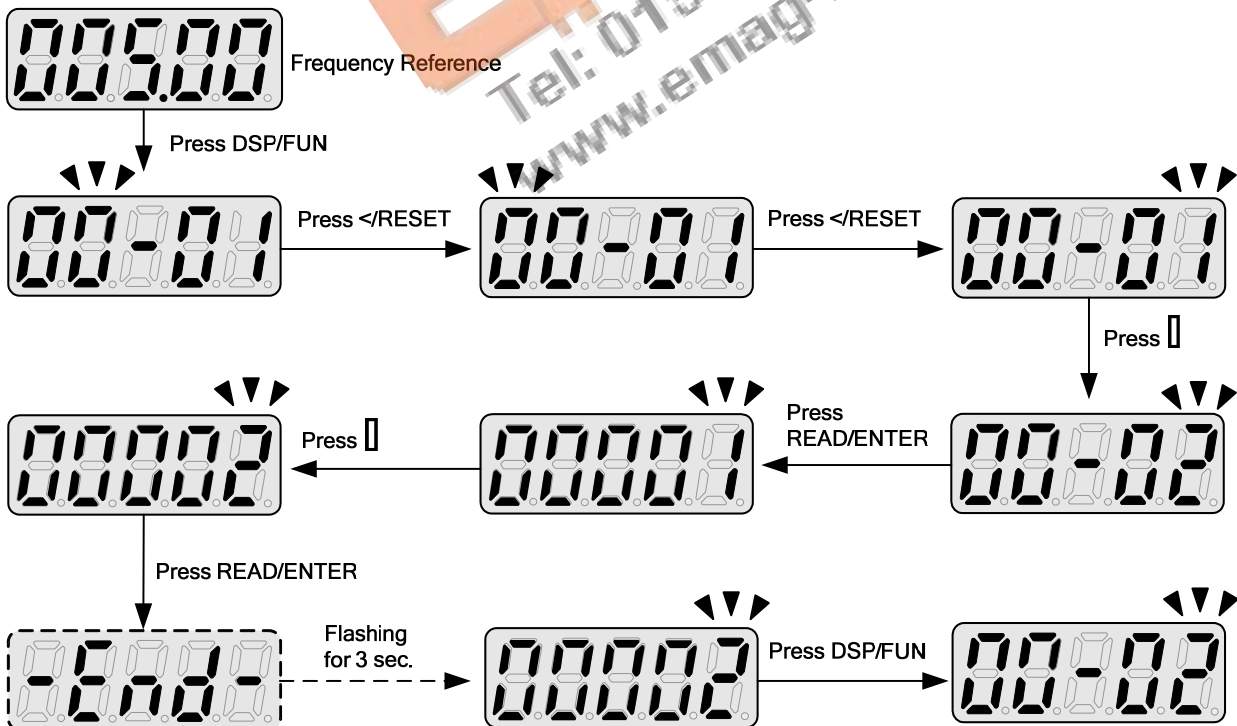

Example: Set Frequency Reference

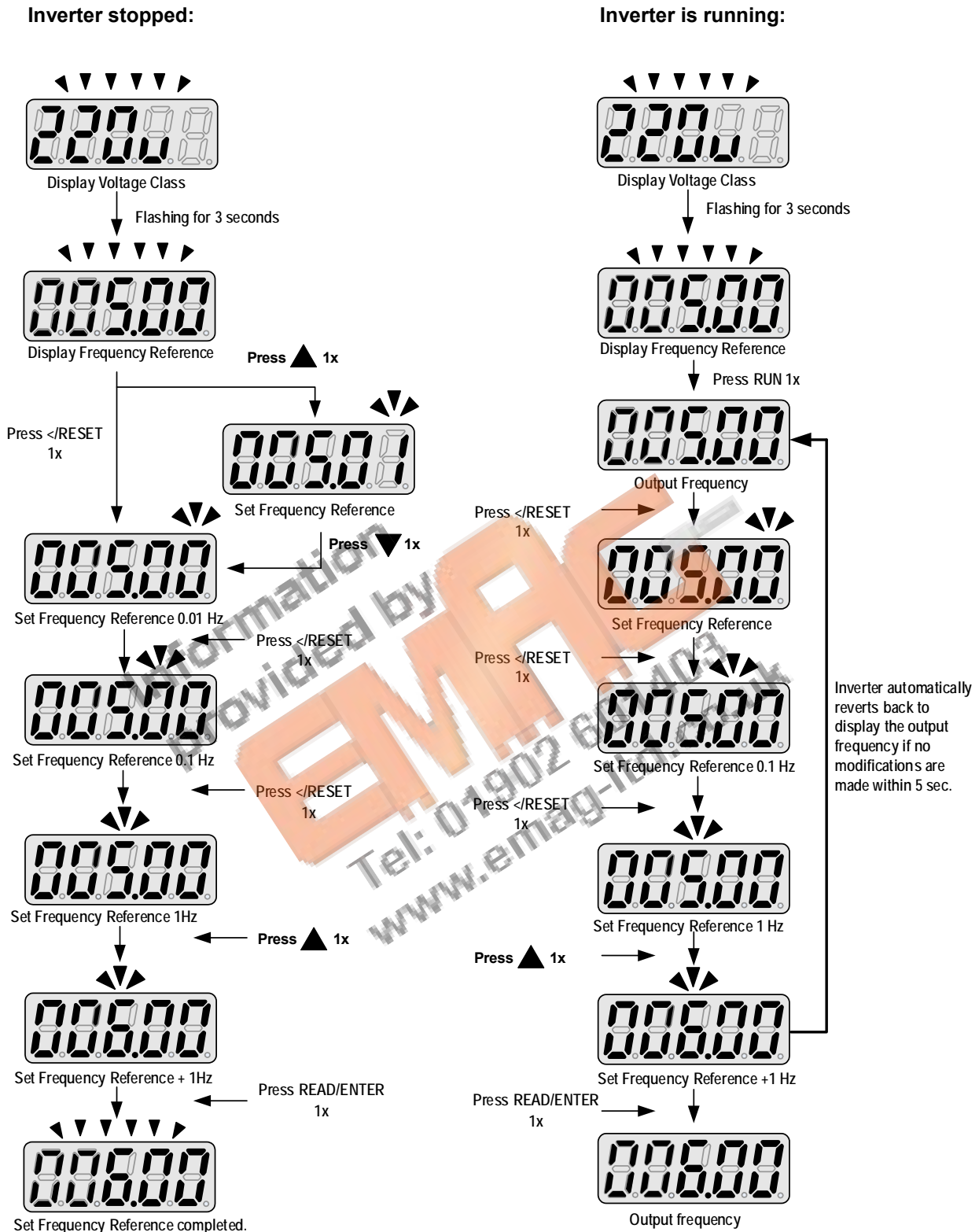

Note: When upper or lower limit is reached during editing of the frequency reference, the edit value will automatically rollover from the lower limit to the upper limit or from the upper limit to the lower limit.

4.1.6 Operation Control

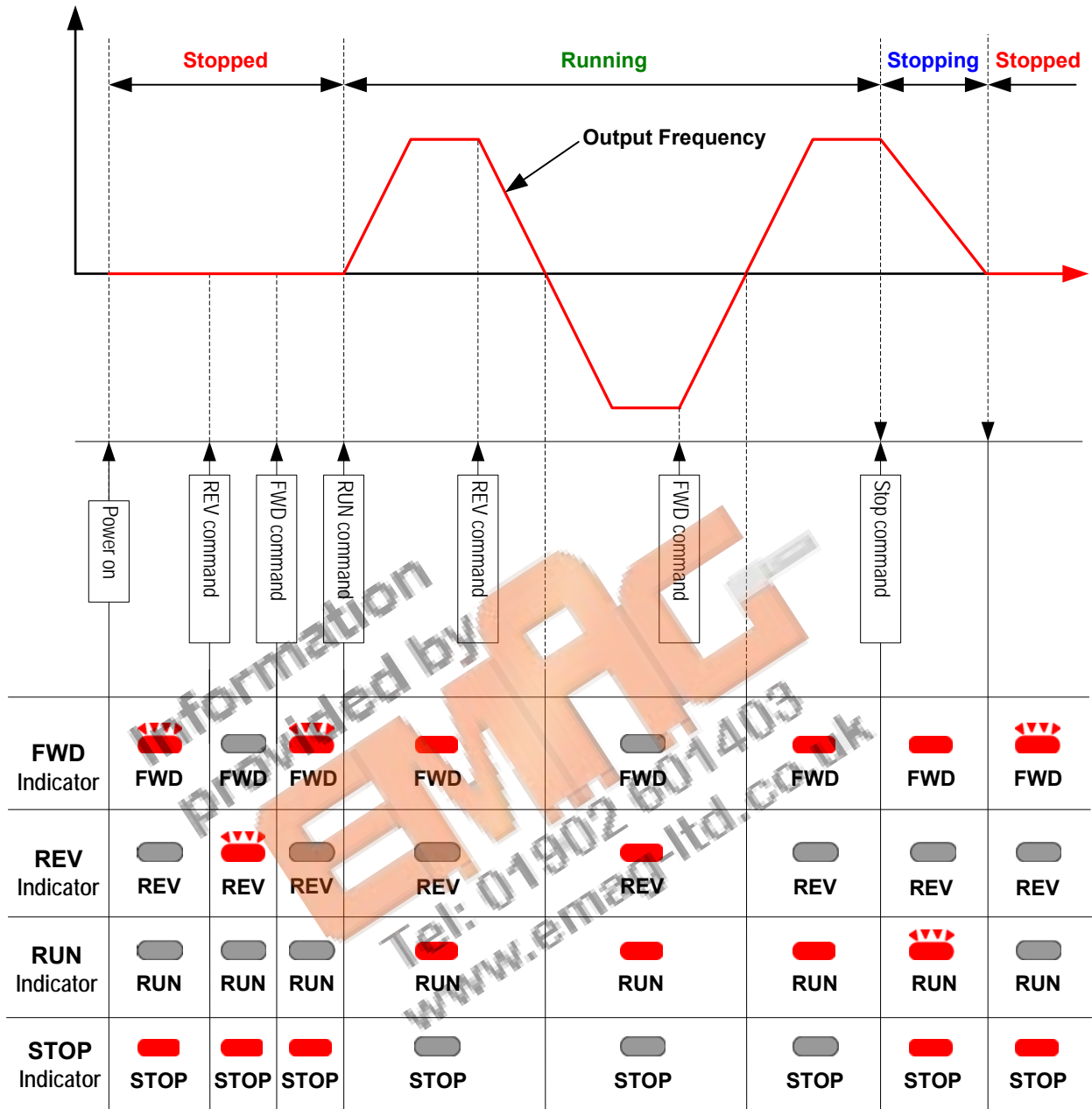

4.2 LCD Keypad (Option)

4.2.1 Keypad Display and Keys



DISPLAY	Description
LCD Display	Monitor inverter signals, view / edit parameters, fault / alarm display.
LED INDICATORS	
FAULT	LED ON when a fault or alarm is active.
FWD	LED ON when inverter is running in forward direction, flashing when stopping.
REV	On when inverter is running in reverse direction, flashing when stopping.
SEQ	LED ON when RUN command is from the external control terminals or from serial communication
REF	LED ON when Frequency Reference command is from the external control terminals or from serial communication

KEYS (8)	Description
RUN	RUN Inverter in Local Mode
STOP	STOP Inverter
▲	Parameter navigation Up, Increase parameter or reference value
▼	Parameter navigation down, decrease parameter or reference value
FWD/REV	Used to switch between Forward and Reverse direction
DSP/FUN	Used to scroll to next screen Frequency screen →Function selection→Monitor parameter
◀ / RESET	Selects active seven segment digit for editing with the ▲ ▼ keys Used to reset fault condition.
READ / ENTER	Used to read and save the value of the active parameter

Auto-Repeat Keys

Holding the ▲UP or ▼DOWN key for a longer period of time will initiate the auto-repeat function resulting in the value of the selected digit to automatically increase or decrease.

4.2.2 Keypad Menu Structure

Main Menu

The A510 inverter main menu consists of two main groups (modes). The DSP/FUN key is used to switch between the monitor mode and the parameter group mode.

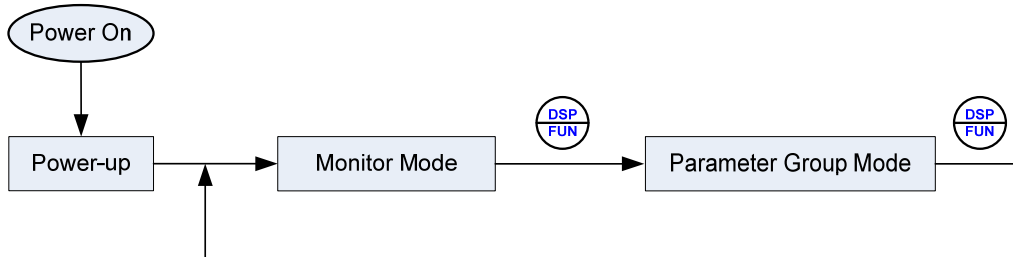

Mode	Description
Monitor Mode	View inverter status, signals and fault data.
Parameter Group Mode	Access to available parameter groups.

All the available parameter groups are listed in the Parameter Group Mode use the up and down keys to select a group and press Read/Enter key to access its parameters.

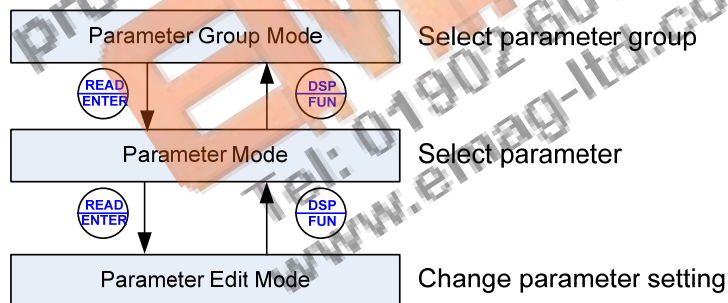

Fig. 4.2.2.1 Parameter Group Structure

Notes:

- Always perform an auto-tune on the motor before operating the inverter in vector control (sensorless vector or flux vector). Auto-tuning mode will not be displayed when the inverter is running or when a fault is active.
- To scroll through the available modes, parameter groups or parameter list press and hold the up or down key.

Monitor Mode

In monitor mode inverter signals can be monitored such as output frequency, output current and output voltage, etc...) as well as fault information and fault trace. See Fig 4.2.2.2 for keypad navigation.

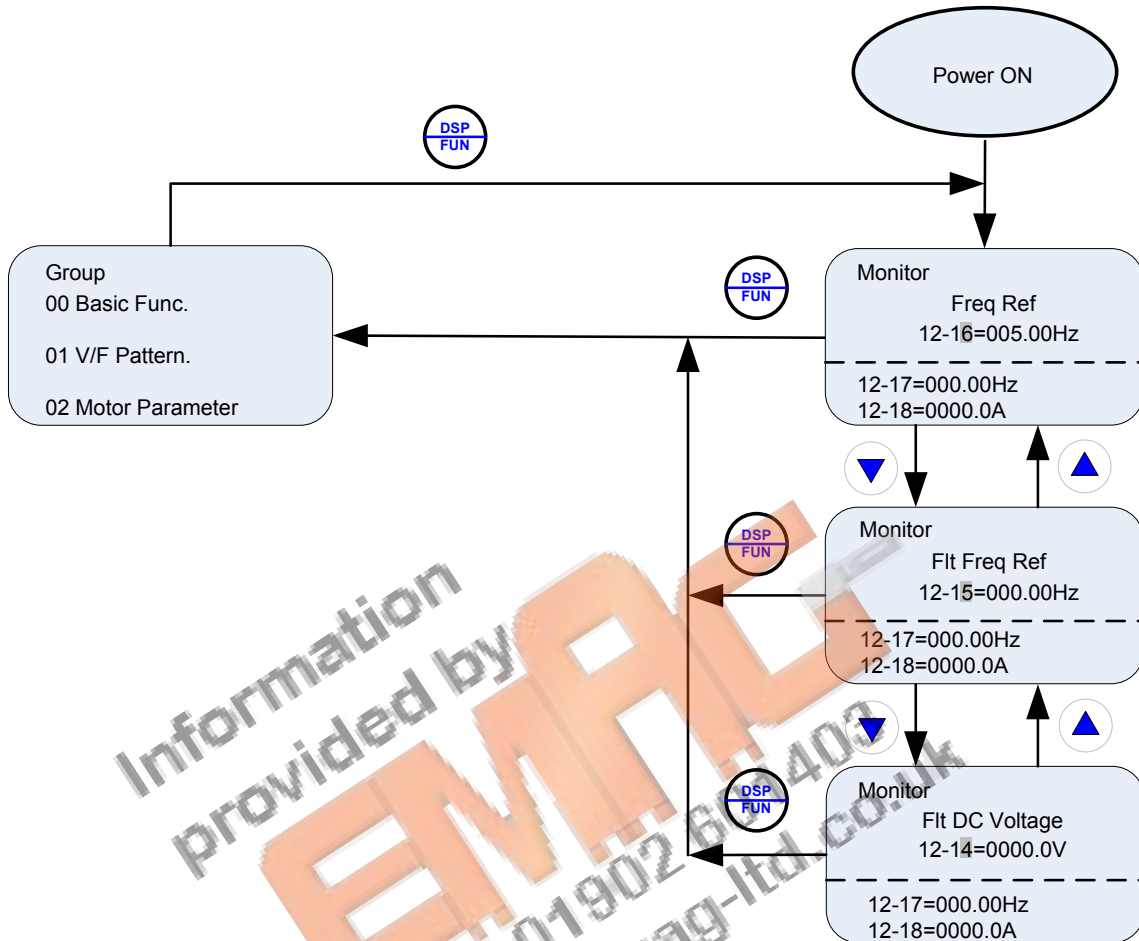

Fig 4.2.2.2 Monitor Mode

Note:

- To scroll through the available monitor parameter list, press and hold the ▲ (up) or ▼ (down) key.

Programming Mode

In programming mode inverter parameters can be read or changed. See Fig 4.2.2.3 for keypad navigation.

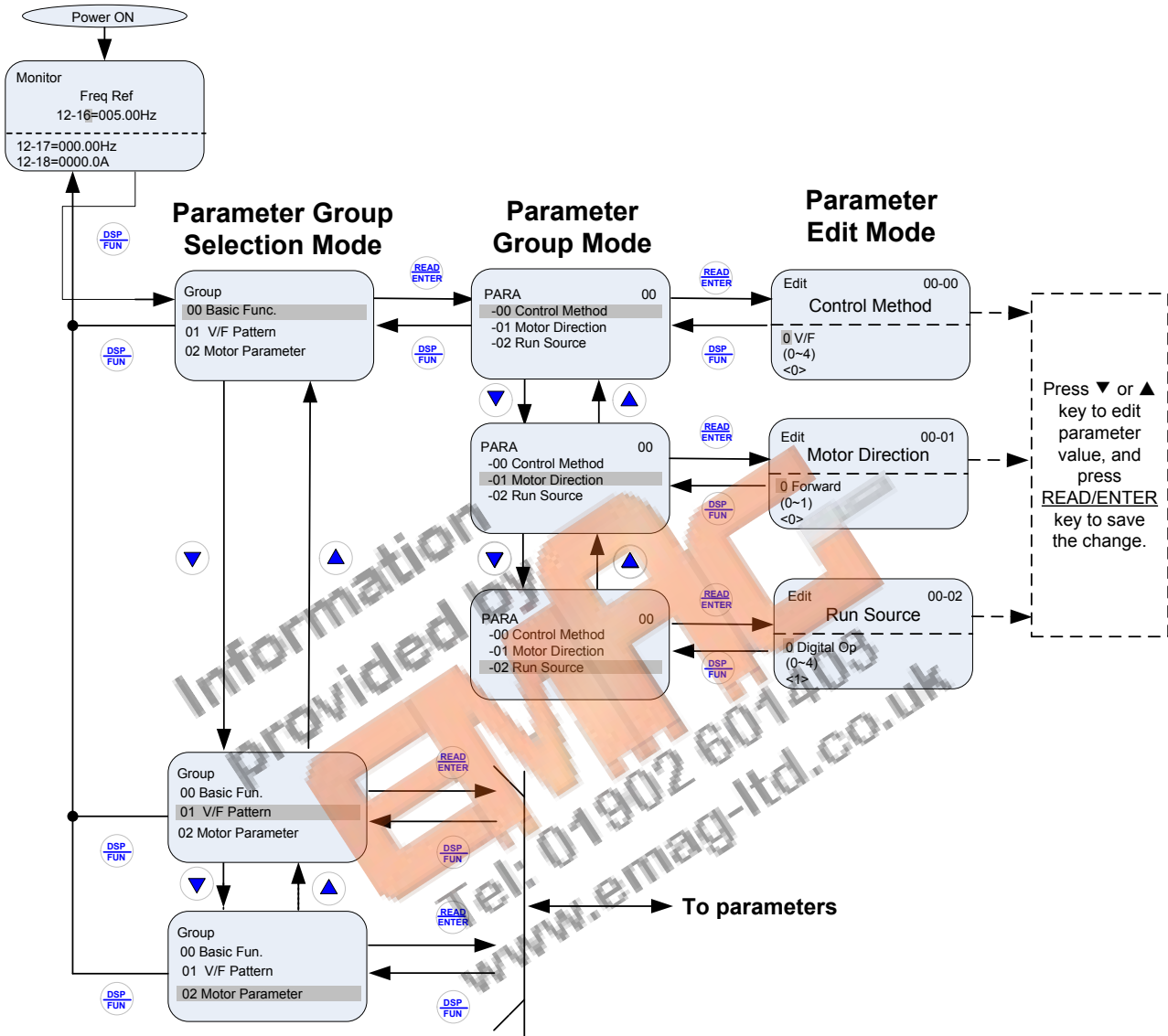

Fig 4.2.2.3 Programming Mode

Notes:

- The parameters values can be changed from the Edit screen with the up, down and < / RESET shift key.
- To save a parameter press the READ/ENTER key.
- Refer to section 4.4 for parameter details.
- Press the ▲ (up) or ▼ (down) key to scroll parameter groups or parameter list.

Auto-tuning Mode

In the auto-tuning mode motor parameters can be calculated and set automatically based on the selected control mode. See Fig 4.2.2.4 for keypad navigation.

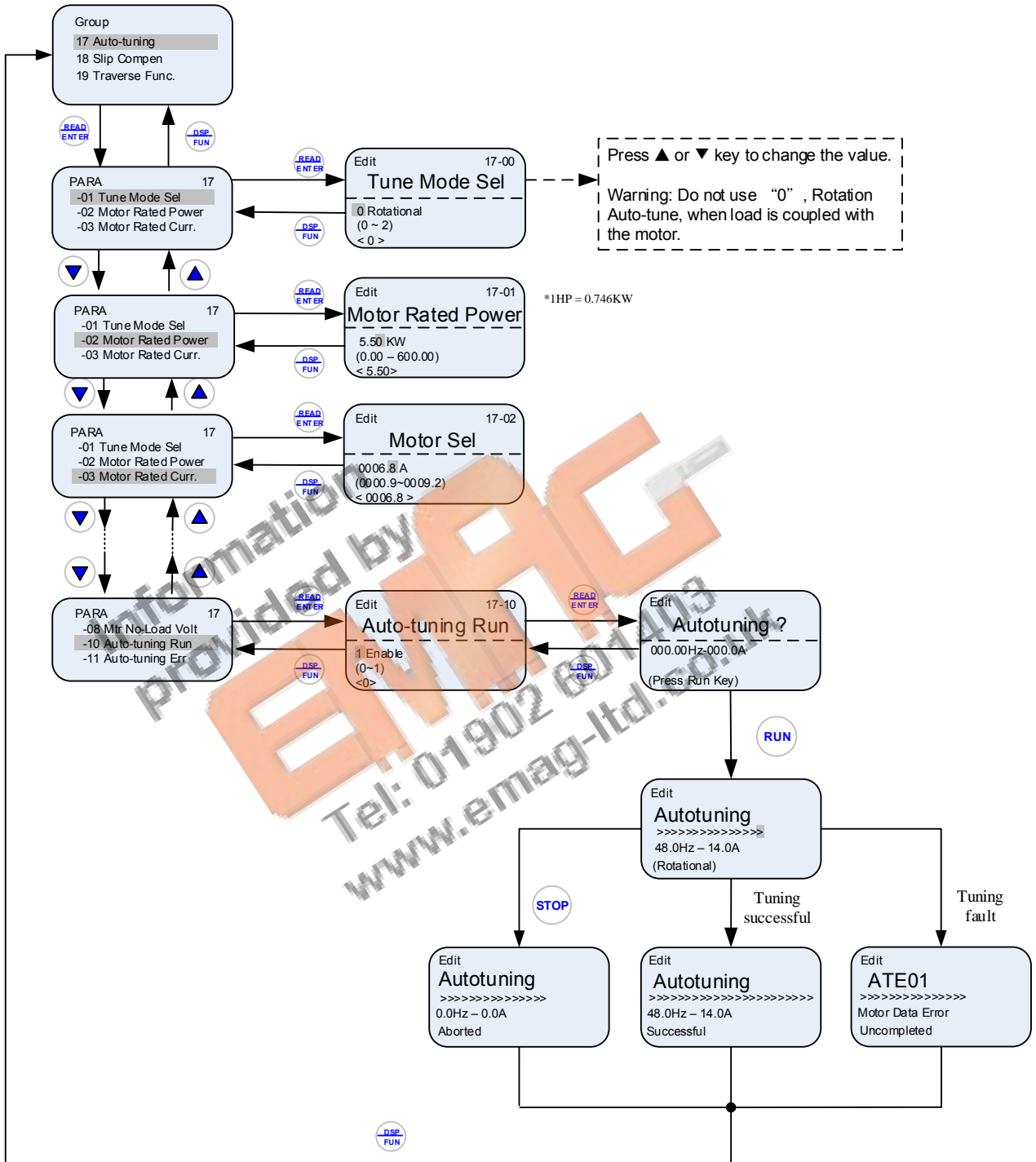

Fig 4.2.2.4 Auto-tuning Mode

Notes:

- Set correct motor parameters by referring to motor nameplate.
- Refer to section 4.4 for parameter details.

4.2.2 Notes:

1. Use the up and down keys to scroll through the auto-tuning parameter list. Depending on the selected control mode in parameter 00-00, part of auto-tuning parameters will not be accessible. (Refer to the Auto-tuning Group 17 parameters).
2. After entering the motor nameplate rated output power (17-01), rated current (17-02), rated voltage (17-03), rated frequency (17-04), rated speed (17-05) and number of motor poles (17-06), select the automatic tuning mode and press the RUN key to perform the auto-tuning operation. When auto-tuning is successful the calculated motor parameters will be saved into parameter group 02 (motor parameter).
3. (a) "Rotational" will be displayed during rotational auto-tuning (17-00=0) and the motor will rotate during auto-tuning. Ensure that it is safe to operate the motor before pressing the RUN key.
(b) "Stationary" will be displayed during stationary auto-tuning (17-00=1), and the motor shaft does not rotate.
(c) "R1 Tuning" will be displayed during stationary auto-tuning (17-00=2), and the motor shaft does not rotate.
(d) "Loop Adjust" will be displayed during stationary auto-tuning (17-00=4), and the motor shaft does not rotate.
(e) The RUN LED (in the upper left corner of the RUN key) will be lit during auto-tuning.
(f) The LCD display shows ">>>" or "Atund" during the auto-tuning process.
4. Press the STOP key on the keypad to abort the auto-tuning operation.
5. In case of an auto-tuning fault, a fault message and the uncompleted message are displayed on the keypad. The RUN LED will be flashing and the motor will coast to stop. (Refer to section 10.4 for the Auto-tuning Faults.) The auto-tuning fault can be cleared by pressing the RESET key after which the keypad displays the auto-tuning mode again.
6. Upon successful completion of an auto-tune, the RUN LED will turn off. Press the DSP/FUN key to return to the main menu to select the next operation. The auto-tuning procedure takes approximately 50 seconds.

4.3 Parameters

Parameter group	Name
Group 00	Basic Parameters
Group 01	V/F Control Parameters
Group 02	IM Motor Parameters
Group 03	External Digital Input and Output Parameters
Group 04	External Analog Input and Output Parameters
Group 05	Multi-Speed Parameters
Group 06	Automatic Program Operation Parameters
Group 07	Start /Stop Parameters
Group 08	Protection Parameters
Group 09	Communication Parameters
Group 10	PID Parameters
Group 11	Auxiliary Parameters
Group 12	Monitoring Parameters
Group 13	Maintenance Parameters
Group 14	PLC Parameters*
Group 15	PLC Monitoring Parameters*
Group 16	LCD Parameters
Group 17	Automatic Tuning Parameters
Group 18	Slip Compensation Parameters
Group 19	Wobble Frequency Parameters
Group 20	Speed Control Parameters
Group 21	Torque And Position Control Parameters
Group 22	PM Motor Parameters

* The standard type of A510 is built-in PLC function. The dedicated type which is marked “-A” behind, is not built-in PLC function.

Parameter Attribute	
*1	Parameters can be changed during run operation.
*2	Read-only parameters for communication
*3	Parameter will not reset to default during a factory reset (initialization).
*4	Read-only parameter

Group 00: Basic Parameters

Code	Parameter Name	Setting Range	Default	Unit	Control mode						Attribute
					V/F	V/F+PG	SLV	SV	PM SV	PM SLV	
00-00	Control Mode Selection	0: V/F	0	-	0	0	0	0	0	-	*3
		1: V/F+PG									
		2: SLV(Sensorless Vector)									
		3: SV (Sensor Vector)									
		4: PMSV									
5: Reserved											
00-01	Motor's Rotation Direction	0: Forward	0	-	0	0	0	0	0	-	*1
		1: Reverse									
00-02	RUN Command Selection	0: Keypad	1	-	0	0	0	0	0	-	
		1: External Terminal (Control Circuit)									
		2: Communication Control (RS-485)									
		3: PLC									
00-03 ~ 00-04	Reserved										
00-05	Main Frequency Command Source Selection	0: Keypad	1	-	0	0	0	0	0	-	
		1: External Terminal (Analog)									
		2: Terminal Command UP/DOWN									
		3: Communication Control (RS-485)									
		4: Pulse Input									
5: PID											
00-06	Alternative Frequency Source Selection	0: Keypad	3	-	0	0	0	0	0	-	
		1: External Terminal (Analog)									
		2: Terminal Command UP/DOWN									
		3: Communication Control (RS-485)									
		4: Pulse Input									
5: PID											
00-07	Main and Alternative Frequency Command Modes	0: Main Frequency	0	-	0	0	0	0	0	-	
		1: Main frequency + Alternative Frequency									
00-08	Communication Frequency Command Range	0.00-400.00 0.0~1200.0 (when 00-31 = 1)	0.00	Hz	0	0	0	0	0	-	
00-09	Communication Frequency Command Memory Selection	0: Don't save when power supply is off. (00-08)	0	-	0	0	0	0	0	-	
		1: Save when power is off. (00-08)									
00-10 ~ 00-11	Reserved										
00-12	Upper Frequency Limit	0.1~109.0	100.0	%	0	0	0	0	0	-	
00-13	Lower Frequency Limit	0.0~109.0	0.0	%	0	0	0	0	0	-	

Group 00: Basic Parameters

Code	Parameter Name	Setting Range	Default	Unit	Control mode						Attribute
					V/F	V/F+PG	SLV	SV	PM SV	PM SLV	
00-14	Acceleration Time 1	0.1~6000.0	-	s	O	O	O	O	O	-	*1
00-15	Deceleration Time 1	0.1~6000.0	-	s	O	O	O	O	O	-	*1
00-16	Acceleration Time 2	0.1~6000.0	-	s	O	O	O	O	O	-	*1
00-17	Deceleration Time 2	0.1~6000.0	-	s	O	O	O	O	O	-	*1
00-18	Jog Frequency	0.00~400.00 0.0~1200.0 (when 00-31 = 1)	6.00 6.0	Hz	O	O	O	O	O	-	*1
00-19	Jog Acceleration Time	0.1~0600.0	-	s	O	O	O	O	O	-	*1
00-20	Jog Deceleration Time	0.1~0600.0	-	s	O	O	O	O	O	-	*1
00-21	Acceleration time 3	0.1~6000.0	-	s	O	O	O	O	O	-	*1
00-22	Deceleration time 3	0.1~6000.0	-	s	O	O	O	O	O	-	*1
00-23	Acceleration time 4	0.1~6000.0	-	s	O	O	O	O	O	-	*1
00-24	Deceleration time 4	0.1~6000.0	-	S	O	O	O	O	O	-	*1
00-25	Switch-Over Frequency of Acc/Dec Time 1 and Time 4	0.0~400.0 0.0~1200.0 (when 00-31 = 1)	0.0	Hz	O	O	O	O	O	-	
00-26	Emergency Stop Time	0.1~6000.0	5.0	s	O	O	O	O	O	-	
00-27	HD/ND Selection	0: HD (Heavy Duty Mode) 1: ND (Normal Duty Mode)	0	-	O	O	X	X	X	-	*3
00-28	Command Characteristic selection of master frequency	0: Positive Characteristic (0~10V/4~20mA is corresponding to 0~100%) 1: Negative Characteristic (0~10V/4~20mA is corresponding to 100~0%)	0	-	O	O	O	O	O	-	
00-29	Zero-Speed Operation Selection	0: Operation Based on Frequency Command 1: Stop 2: Operation Based on the Lowest Frequency 3: Zero-Speed Operation	0	-	X	X	X	O	O	-	
00-30	Reserved										
00-31	Maximum Frequency Selection	0: 400.00Hz 1: 1200.0Hz	0	-	O	O	X	X	X	-	*3
00-32	Application Selection Presets	0: Disabled 1: Water Supply Pump 2: Conveyor 3: Exhaust Fan 4: HVAC 5: Compressor 6: Hoist** 7: Crane**	0	-	O	O	O	O	O	-	

** : External safety and load drop protection must be installed for the use in lifting applications.

Group 01: V/F Control Parameters

Code	Parameter Name	Setting Range	Default	Unit	Control mode						Attribute
					V/F	V/F+PG	SLV	SV	PM SV	PM SLV	
01-00	V/F Curve Selection	0~FF	F	-	O	O	X	X	X	-	*3
01-01	Reserved										
01-02	Maximum Output Frequency of Motor 1	20.0~400.0 20.0~1200.0 (when 00-31 = 1)	60.0	Hz	O	O	O	O	O	-	
01-03	Maximum Output Voltage of Motor 1	200V: 0.1~255.0	220.0	V	O	O	X	X	X	-	
		400V: 0.2~510.0	440.0								
01-04	Middle Output Frequency 2 of Motor 1	0.0~400.0 0.0~1200.0 (when 00-31 = 1)	0.0	Hz	O	O	X	X	X	-	
01-05	Middle Output Voltage 2 of Motor 1	200V: 0.0~255.0	0.0	V	O	O	X	X	X	-	
		400V: 0.0~510.0									
01-06	Middle Output Frequency 1 of Motor 1	0.0~400.0 0.0~1200.0 (when 00-31 = 1)	3.0	Hz	O	O	X	X	X	-	
01-07	Middle Output Voltage 1 of Motor 1 (for 3~30HP)	200V: 0.0~255.0	14.0	V	O	O	X	X	X	-	
		400V: 0.0~510.0	28.0								
01-08	Minimum Output Frequency of Motor 1	0.0~400.0 0.0~1200.0 (when 00-31 = 1)	1.5	Hz	O	O	O	O	O	-	
01-09	Minimum Output Voltage of Motor 1 (for 3~30HP)	200V: 0.0~255.0	7.5	V	O	O	X	X	X	-	
		400V: 0.0~510.0	15.0								
01-10	Torque Compensation Gain	0.0~2.0	0.5	-	O	O	X	X	X	-	*1
01-11	Reserved										
01-12	Base Frequency of Motor 1	10.0~400.0 10.0~1200.0 (when 00-31 = 1)	60.0	Hz	O	O	O	O	O	-	
01-13	Base Output Voltage of Motor 1	200V: 0.0~255.0	220.0	V	O	O	X	X	X	-	
		400V: 0.0~510.0	440.0								
01-14	Input Voltage Setting	200V: 155.0~255.0	220.0	V	O	O	O	O	O	-	
		400V: 310.0~510.0	440.0								
01-15	Torque Compensation Time	1~10000	200	ms	O	O	X	X	X	-	
01-16	Maximum Output Frequency of Motor 2	20.0~400.0 20.0~1200.0 (when 00-31 = 1)	60.0	Hz	O	O	O	O	O	-	
01-17	Maximum Output Voltage of Motor 2	200V: 0.1~255.0	220.0	V	O	O	X	X	X	-	
		400V: 0.2~510.0	440.0								
01-18	Middle Output Frequency 2 of Motor 2	0.0~400.0 0.0~1200.0 (when 00-31 = 1)	0.0	Hz	O	O	X	X	X	-	
01-19	Middle Output Voltage 2 of Motor 2	200V: 0.0~255.0	0.0	V	O	O	X	X	X	-	
		400V: 0.0~510.0									
01-20	Middle Output Frequency 1 of Motor 2	0.0~400.0 0.0~1200.0 (when 00-31 = 1)	3.0	Hz	O	O	X	X	X	-	
01-21	Middle Output Voltage 1 of Motor 2 (for 3~30HP)	200V: 0.0~255.0	14.0	V	O	O	X	X	X	-	
		400V: 0.0~510.0	28.0								
01-22	Minimum Output Frequency of Motor 2	0.0~400.0 0.0~1200.0 (when 00-31 = 1)	1.5	Hz	O	O	O	O	O	-	
01-23	Minimum Output Voltage of Motor 2 (for 3~30HP)	200V: 0.0~255.0	7.5	V	O	O	X	X	X	-	
		400V: 0.0~510.0	15.0								

Group 01: V/F Control Parameters

Code	Parameter Name	Setting Range	Default	Unit	Control mode						Attribute
					V/F	V/F+PG	SLV	SV	PM SV	PM SLV	
01-24	Base Frequency of Motor 2	10.0~400.0 10.0~1200.0 (when 00-31 = 1)	60.0	Hz	0	0	0	0	0	-	
01-25	Base Output Voltage of Motor 2	200V: 0.0~255.0	220.0	V	0	0	X	X	X	-	
		400V: 0.0~510.0	440.0								

Group 02: IM Motor Parameters

Code	Parameter Name	Setting Range	Default	Unit	Control mode						Attribute
					V/F	V/F+PG	SLV	SV	PM SV	PM SLV	
02-00	No-Load Current of Motor1	0.01~600.00	-	A	0	X	X	X	X	-	
02-01	Rated Current of Motor1	Modes of V/F, V/F+PG are 10%~200% of inverter's rated current. Modes of SLV, SV are 25%~200% of inverter's rated current.	-	A	0	0	0	0	X	-	
02-02	Reserved										
02-03	Rated Rotation Speed of Motor1	0~60000	-	Rpm	0	0	0	0	X	-	
02-04	Rated Voltage of Motor1	200V: 50.0~240.0	220.0	V	0	0	0	0	X	-	
		400V: 100.0~480.0	440.0								
02-05	Rated Power of Motor1	0.01~600.00	-	kW	0	0	0	0	X	-	
02-06	Rated Frequency of Motor1	10.0~400.0 10.0~1200.0 (when 00-31 = 1)	60.0	Hz	0	0	0	0	X	-	
02-07	Poles of Motor 1	2,4,6,8,10,12,14,16	4	-	0	0	0	0	X	-	
02-08	Reserved										
02-09	Excitation Current of Motor 1	15%~70% of Motor Rated Current	-	%	X	X	0	0	X	-	
02-10	Core Saturation Coefficient 1 of Motor 1	0~100	-	%	X	X	0	0	X	-	
02-11	Core Saturation Coefficient 2 of Motor 1	0~100	-	%	X	X	0	0	X	-	
02-12	Core Saturation Coefficient 3 of Motor 1	80~300	-	%	X	X	0	0	X	-	
02-13	Core loss of Motor 1	0.0~15.0	-	%	0	0	X	X	X	-	
02-14	Reserved										
02-15	Resistance between Wires of Motor 1	0.001~60.000	-	Ω	0	0	0	0	X	-	
02-16	Rotor Resistance of Motor 1	0.001~60.000	-	Ω	X	X	0	0	X	-	
02-17	Leakage Inductance of Motor 1	0.01~200.00	-	mH	X	X	0	0	X	-	

Group 02: IM Motor Parameters

Code	Parameter Name	Setting Range	Default	Unit	Control mode						Attribute
					V/F	V/F+PG	SLV	SV	PM SV	PM SLV	
02-18	Mutual Inductance of Motor 1	0.1~6553.5	-	mH	X	X	O	O	X	-	
02-19	No-Load Voltage of Motor 1	200V: 50~240	-	V	X	X	O	O	X	-	
		400V: 100~480	-								
02-20	No-Load Current of Motor 2	0.01~600.00	-	A	O	X	X	X	X	-	
02-21	Rated Current of Motor 2	10%~200% of inverter's rated current	-	A	O	O	X	X	X	-	
02-22	Rated Rotation Speed of Motor 2	0~60000	-	Rpm	O	O	X	X	X	-	
02-23	Rated Voltage of Motor 2	200V: 50.0~240.0	220.0	V	O	O	X	X	X	-	
		400V: 100.0~480.0	440.0								
02-24	Rated Power of Motor 2	0.01~600.00	-	kW	O	O	X	X	X	-	
02-25	Rated Frequency of Motor 2	10.0~400.0 10.0~1200.0 (when 00-31 = 1)	60.0	Hz	O	O	X	X	X	-	
02-26	Poles of Motor 2	2,4,6,8,10,12,14,16	4	-	O	O	O	O	X	-	
02-27 ~ 02-31	Reserved										
02-32	Resistance between Wires of Motor 2	0.001~60.000	-	Ω	O	O	X	X	X	-	
02-33 ~ 02-36	Reserved										

Group 03: External Digital Input and Output Parameters

Code	Parameter Name	Setting Range	Default	Unit	Control mode						Attribute
					V/F	V/F+PG	SLV	SV	PM SV	PM SLV	
03-00	Multi-Function Terminal Function Setting-S1	0: 2-Wire Sequence (ON: Forward Run Command). 1: 2-Wire Sequence (ON: Reverse Run Command). 2: Multi-Speed/Position Setting Command 1 3: Multi-Speed/Position Setting Command 2 4: Multi-Speed/Position Setting Command 3 5: Multi-Speed/Position Setting Command 4 6: Forward Jog Run Command 7: Reverse Jog Run Command 8: UP Frequency Increasing Command	0	-	O	O	O	O	O	-	
03-01	Multi-Function Terminal Function Setting-S2		1	-	O	O	O	O	O	-	
03-02	Multi-Function Terminal Function Setting-S3		8	-	O	O	O	O	O	-	
03-03	Multi-Function Terminal Function Setting-S4		9	-	O	O	O	O	O	-	
03-04	Multi-Function Terminal Function Setting-S5		2	-	O	O	O	O	O	-	
03-05	Multi-Function Terminal Function Setting-S6		17	-	O	O	O	O	O	-	
03-06	Multi-Function Terminal Function Setting-S7		Two-wire type:29	-	O	O	O	O	O	-	
			Three-wire type:26	-	O	O	O	O	O	-	
03-07	Multi-Function Terminal Function Setting-S8	15	-	O	O	O	O	O	-		

Group 03: External Digital Input and Output Parameters

Code	Parameter Name	Setting Range	Default	Unit	Control mode						Attribute
					V/F	V/F +PG	SLV	SV	PM SV	PM SLV	
		9: DOWN Frequency Decreasing Command 10: Acceleration/Deceleration Setting Command 1 11: Inhibit Acceleration/ Deceleration Command 12~13: Reserved 14: Emergency Stop (decelerate to zero and stop) 15: External Baseblock Command (rotation freely to stop) 16: PID Control Disable 17: Fault Reset (RESET) 18: Reserved 19: Speed Search 1 (from the maximum frequency) 20: Manual Energy Saving Function 21: PID Integral Reset 22~23 : Reserved 24: PLC Input 25: External Fault 26: 3-Wire Sequence (Forward/Reverse command). 27: Local/Remote Selection 28: Remote Mode Selection 29: Jog Frequency Selection 30: Acceleration/Deceleration Setting Command 2 31: Inverter Overheating Warning 32: Sync Command 33: DC Braking 34: Speed Search 2 (from the frequency command) 35: Timing Function Input 36: PID Soft Start Disable 37: Traversing Operation 38: Upper Deviation of Traverse Operation 39: Lower Deviation of Traverse Operation 40: Switching between Motor 1/Motor 2 41: Reserved 42: PG Disable 43: PG Integral Reset 44: Mode Switching between Speed and Torque									

Group 03: External Digital Input and Output Parameters

Code	Parameter Name	Setting Range	Default	Unit	Control mode						Attribute
					V/F	V/F +PG	SLV	SV	PM SV	PM SLV	
		45: Negative Torque Command 46: Zero-Servo Command 47: Fire Mode 48: KEB Acceleration 49: Parameters Writing Allowable 50: Unattended Start Protection (USP) 51: Mode Switching between Speed and Position 52: Multi Position Reference Enable 53: 2-Wire Stop (2-Wire Self Holding Mode)									
03-08	(S1~S8) DI Scan Time	0: Scan Time 4ms 1: Scan Time 8ms	1	-	0	0	0	0	0	-	
03-09	Multi-Function Terminal S1-S4 Type Selection	xxx0b: S1 A Contact xxx1b: S1 B Contact	0000b	-	0	0	0	0	0	-	
		xx0xb: S2 A Contact xx1xb: S2 B Contact									
		x0xxb: S3 A Contact x1xxb: S3 B Contact									
		0xxxb: S4 A Contact 1xxxb: S4 B Contact									
03-10	Multi-Function Terminal S5-S8 Type Selection	xxx0b: S5 A Contact xxx1b: S5 B Contact	0000b	-	0	0	0	0	0	-	
		xx0xb: S6 A Contact xx1xb: S6 B Contact									
		x0xxb: S7 A Contact x1xxb: S7 B Contact									
		0xxxb: S8 A Contact 1xxxb: S8 B Contact									

Group 03: External Digital Input and Output Parameters

Code	Parameter Name	Setting Range	Default	Unit	Control mode						Attribute
					V/F	V/F +PG	SLV	SV	PM SV	PM SLV	
03-11	Relay (R1A-R1C) Output	0: During Running 1: Fault Contact Output	1	-	0	0	0	0	0	-	
03-12	Relay (R2A-R2C) Output (*DO2 for Frame 1)	2: Frequency Agree 3: Setting Frequency Agree 4: Frequency Detection 1 (> 03-13) 5: Frequency Detection 2 (< 03-13) 6: Automatic Restart 7~8: Reserved 9: Baseblock 10~11: Reserved 12: Over-Torque Detection 13~17: Reserved 18: PLC status 19: PLC Control Contact 20: Zero Speed 21: Inverter Ready 22: Undervoltage Detection 23: Source of Operation Command 24: Source of Frequency Command 25: Low Torque Detection 26: Frequency Reference Missing 27: Timing Function Output 28: Traverse Operation UP Status 29 : During Traverse Operation Status 30 : Motor 2 Selection 31 : Zero Servo Completed 32: Communication Control Contacts	20	-	0	0	0	0	0	-	
03-13	Frequency Detection Level	0.0~400.0 0.0~1200.0 (when 00-31 = 1)	0.0	Hz	0	0	0	0	0	-	
03-14	Frequency Detection Width	0.1~25.5	2.0	Hz	0	0	0	0	0	-	
03-15 ~ 03-18	Reserved										
03-19	Relay (R1A-R2A) Type	xxx0b: R1 A Contact xxx1b: R1 B Contact xx0xb: R2 A Contact (DO2 for F1) xx1xb: R2 C Contact	0000b	-	0	0	0	0	0	-	
03-20 ~ 03-26	Reserved										

Group 03: External Digital Input and Output Parameters

Code	Parameter Name	Setting Range	Default	Unit	Control mode						Attribute
					V/F	V/F +PG	SLV	SV	PM SV	PM SLV	
03-27	UP/DOWN Frequency Hold/Adjust Selection	0: Hold last set frequency when stopped	0	-	0	0	0	0	0	-	
		1: Set frequency to 0 when stopped									
		2: Allow speed changes from last set frequency when stopped									
03-28	Photo-coupler Output	Range and definition are the same as those of 03-11, 03-12	0	-	0	0	0	0	0	-	
03-29	Photo-coupler Output Selection	xxx0b: Photo-coupler A Contact xxx1b: Photo-coupler B Contact	0000b	-	0	0	0	0	0	-	
03-30	Function Setting of Pulse Input	0: Frequency Command	0	-	0	0	0	0	0	-	
		1: PID Feedback									
		2: PID Target Value									
		3: Reserved									
03-31	Scale of Pulse Input	50~32000	1000	Hz	0	0	0	0	0	-	*1
03-32	Gain of Pulse Input	0.0~1000.0	100	%	0	0	0	0	0	-	*1
03-33	Bias of Pulse Input	-100.0~100.0	0.0	%	0	0	0	0	0	-	*1
03-34	Filter Time of Pulse Input	0.00~2.00	0.1	Sec	0	0	0	0	0	-	*1
03-35	Function Setting of Pulse Output	1: Frequency Command	2	-	0	0	0	0	0	-	*1
		2: Output Frequency									
		3: Output Frequency after Soft-Start									
		4: Motor Speed									
		5: PID Feedback									
		6: PID Input									
		7: PG Output									
03-36	Scale of Pulse Output	1Hz ~ 32000Hz	1000	Hz	0	0	0	0	0	-	*1
03-37	Timer ON Delay (DIO)	0.0s ~ 6000.0s	0.0	s	0	0	0	0	0	-	
03-38	Timer OFF Delay (DIO)	0.0s ~ 6000.0s	0.0	s	0	0	0	0	0	-	

Group 04: External Analog Input and Output Parameters

Code	Parameter Name	Setting Range	Default	Unit	Control mode						Attribute
					V/F	V/F +PG	SLV	SV	PM SV	PM SLV	
04-00	AI Input Signal Type	0: AI1: 0~10V AI2: 0~10V	1	-	0	0	0	0	0	-	
		1: AI1: 0~10V AI2: 4~20mA									
		2: AI1: -10~10V AI2: 0~10V									
		3: AI1: -10~10V AI2: 4~20mA									
04-01	AI1 Signal Scanning and Filtering Time	0.00~2.00	0.03	s	0	0	0	0	0	-	
04-02	AI1 Gain	0.0~1000.0	100.0	%	0	0	0	0	0	-	*1
04-03	AI1 Bias	-100.0~100.0	0	%	0	0	0	0	0	-	*1
04-04	Reserved										
04-05	AI2 Function Setting	0: Auxiliary Frequency	10	-	0	0	0	0	0	-	
		1: Frequency Reference Gain									
		2: Frequency Reference Bias									
		3: Output Voltage Bias									
		4: Coefficient of Acceleration and Deceleration Reduction									
		5: DC Braking Current									
		6: Over-Torque Detection Level									
		7: Stall Prevention Level During Running									
		8: Frequency Lower Limit									
		9: Jump Frequency 4									
		10: Added to AI1									
		11: Positive torque limit									
		12: Negative torque limit									
		13: Regenerative Torque Limit									
		14: Positive / Negative Torque Limit									
		15: Torque Reference/ Torque Limit (in Speed Control)									
		16: Torque Compensation									
17: No Function											
04-06	AI2 Signal Scanning and Filtering Time	0.00~2.00	0.03	s	0	0	0	0	0	-	
04-07	AI2 Gain	0.0~1000.0	100.0	%	0	0	0	0	0	-	*1
04-08	AI2 Bias	-100.0~100.0	0	%	0	0	0	0	0	-	*1
04-09 ~ 04-10	Reserved										
04-11	AO1 Function Setting	0: Output Frequency	0	-	0	0	0	0	0	-	
		1: Frequency Command									
		2: Output Voltage									

Group 04: External Analog Input and Output Parameters

Code	Parameter Name	Setting Range	Default	Unit	Control mode						Attribute
					V/F	V/F +PG	SLV	SV	PM SV	PM SLV	
		3: DC Voltage									
		4: Output Current									
		5: Output Power									
		6: Motor Speed									
		7: Output Power Factor									
		8: AI1 Input									
		9: AI2 Input									
		10: Torque Command									
		11: q-axis Current									
		12: d-axis Current									
		13: Speed Deviation									
		14: Reserved									
		15: ASR Output									
		16: Reserved									
		17: q-axis Voltage									
		18: d-axis Voltage									
		19~20: Reserved									
		21: PID Input									
		22: PID Output									
		23: PID Target Value									
		24: PID Feedback Value									
		25: Output Frequency of the Soft Starter									
		26: PG Feedback									
		27: PG Compensation Volume									
04-12	AO1 Gain	0.0~1000.0	100.0	%	0	0	0	0	0	-	*1
04-13	AO1 Bias	-100.0~100.0	0	%	0	0	0	0	0	-	*1
04-14 ~ 04-15	Reserved										
04-16	AO2 Function Setting	Range and definition are the same as those of 04-11.	3	-	0	0	0	0	0	-	
04-17	AO2 Gain	0.0~1000.0	100.0	%	0	0	0	0	0	-	*1
04-18	AO2 Bias	-100.0~100.0	0	%	0	0	0	0	0	-	*1

Group 05: Multi-Speed Parameters

Code	Parameter Name	Setting Range	Default	Unit	Control mode						Attribute
					V/F	V/F +PG	SLV	SV	PM SV	PM SLV	
05-00	Acceleration and Deceleration Selection of Multi-Speed	0: Acceleration and deceleration time are set by 00-14 ~ 00-24	0	-	O	O	O	O	O	-	
		1: Acceleration and Deceleration Time are set by 05-17 ~ 05-48									
05-01	Frequency Setting of Speed-Stage 0	0.00~400.00 0.0~1200.0 (when 00-31 = 1)	5.00	Hz	O	O	O	O	O	-	*1
05-02 ~ 05-16	Reserved										
05-17	Acceleration Time Setting of Multi Speed 0	0.1~6000.0	10.0	s	O	O	O	O	O	-	
05-18	Deceleration Time Setting of Multi Speed 0	0.1~6000.0	10.0	s	O	O	O	O	O	-	
05-19	Acceleration Time Setting of Multi Speed 1	0.1~6000.0	10.0	s	O	O	O	O	O	-	
05-20	Deceleration Time Setting of Multi Speed 1	0.1~6000.0	10.0	s	O	O	O	O	O	-	
05-21	Acceleration Time Setting of Multi Speed 2	0.1~6000.0	10.0	s	O	O	O	O	O	-	
05-22	Deceleration Time Setting of Multi Speed 2	0.1~6000.0	10.0	s	O	O	O	O	O	-	
05-23	Acceleration Time Setting of Multi Speed 3	0.1~6000.0	10.0	s	O	O	O	O	O	-	
05-24	Deceleration Time Setting of Multi Speed 3	0.1~6000.0	10.0	s	O	O	O	O	O	-	
05-25	Acceleration Time Setting of Multi Speed 4	0.1~6000.0	10.0	s	O	O	O	O	O	-	
05-26	Deceleration Time Setting of Multi Speed 4	0.1~6000.0	10.0	s	O	O	O	O	O	-	
05-27	Acceleration Time Setting of Multi Speed 5	0.1~6000.0	10.0	s	O	O	O	O	O	-	
05-28	Deceleration Time Setting of Multi Speed 5	0.1~6000.0	10.0	s	O	O	O	O	O	-	
05-29	Acceleration Time Setting of Multi Speed 6	0.1~6000.0	10.0	s	O	O	O	O	O	-	
05-30	Deceleration Time Setting of Multi Speed 6	0.1~6000.0	10.0	s	O	O	O	O	O	-	
05-31	Acceleration Time Setting of Multi Speed 7	0.1~6000.0	10.0	s	O	O	O	O	O	-	
05-32	Deceleration Time Setting of Multi Speed 7	0.1~6000.0	10.0	s	O	O	O	O	O	-	
05-33	Acceleration Time Setting of Multi Speed 8	0.1~6000.0	10.0	s	O	O	O	O	O	-	
05-34	Deceleration Time Setting of Multi Speed 8	0.1~6000.0	10.0	s	O	O	O	O	O	-	
05-35	Acceleration Time Setting of Multi Speed 9	0.1~6000.0	10.0	s	O	O	O	O	O	-	

Group 05: Multi-Speed Parameters											
Code	Parameter Name	Setting Range	Default	Unit	Control mode						Attribute
					V/ F	V/F +PG	SLV	SV	PM SV	PM SLV	
05-36	Deceleration Time Setting of Multi Speed 9	0.1~6000.0	10.0	s	O	O	O	O	O	-	
05-37	Acceleration Time Setting of Multi Speed 10	0.1~6000.0	10.0	s	O	O	O	O	O	-	
05-38	Deceleration Time Setting of Multi Speed 10	0.1~6000.0	10.0	s	O	O	O	O	O	-	
05-39	Acceleration Time Setting of Multi Speed 11	0.1~6000.0	10.0	s	O	O	O	O	O	-	
05-40	Deceleration Time Setting of Multi Speed 11	0.1~6000.0	10.0	s	O	O	O	O	O	-	
05-41	Acceleration Time Setting of Multi Speed 12	0.1~6000.0	10.0	s	O	O	O	O	O	-	
05-42	Deceleration Time Setting of Multi Speed 12	0.1~6000.0	10.0	s	O	O	O	O	O	-	
05-43	Acceleration Time Setting of Multi Speed 13	0.1~6000.0	10.0	s	O	O	O	O	O	-	
05-44	Deceleration Time Setting of Multi Speed 13	0.1~6000.0	10.0	s	O	O	O	O	O	-	
05-45	Acceleration Time Setting of Multi Speed 14	0.1~6000.0	10.0	s	O	O	O	O	O	-	
05-46	Deceleration Time Setting of Multi Speed 14	0.1~6000.0	10.0	s	O	O	O	O	O	-	
05-47	Acceleration Time Setting of Multi Speed 15	0.1~6000.0	10.0	s	O	O	O	O	O	-	
05-48	Deceleration Time Setting of Multi Speed 15	0.1~6000.0	10.0	s	O	O	O	O	O	-	

Group 06: Automatic Program Operation Parameters

Code	Parameter Name	Setting Range	Default	Unit	Control mode					Attribute	
					V/F	V/F +PG	SLV	SV	PM SV		PM SLV
06-00	Automatic Operation Mode Selection	0: Disable	0	-	O	O	O	X	O	-	
		1: Execute a single cycle operation mode. Restart speed is based on the previous stopped speed.									
		2: Execute continuous cycle operation mode. Restart speed is based on the previous stopped speed.									
		3: After the completion of a single cycle, the on-going operation speed is based on the speed of the last stage. Restart speed is based on the previous stopped speed.									
		4: Execute a single cycle operation mode. Restart speed will be based on the speed of stage 1.									
		5: Execute continuous cycle operation mode. Restart speed will be based on the speed of stage 1.									
6: After the completion of a single cycle, the on-going operation speed is based on the speed of the last stage. Restart speed is based on the previous stopped speed.											
06-01	Frequency Setting of Speed-Stage 1	0.00~400.00 0.0~1200.0 (when 00-31 = 1)	5.00	Hz	O	O	O	O	O	-	*1
06-02	Frequency Setting of Speed-Stage 2	0.00~400.00 0.0~1200.0 (when 00-31 = 1)	10.00	Hz	O	O	O	O	O	-	*1
06-03	Frequency Setting of Speed-Stage 3	0.00~400.00 0.0~1200.0 (when 00-31 = 1)	20.00	Hz	O	O	O	O	O	-	*1
06-04	Frequency Setting of Speed-Stage 4	0.00~400.00 0.0~1200.0 (when 00-31 = 1)	30.00	Hz	O	O	O	O	O	-	*1
06-05	Frequency Setting of Speed-Stage 5	0.00~400.00 0.0~1200.0 (when 00-31 = 1)	40.00	Hz	O	O	O	O	O	-	*1
06-06	Frequency Setting of Speed-Stage 6	0.00~400.00 0.0~1200.0 (when 00-31 = 1)	50.00	Hz	O	O	O	O	O	-	*1
06-07	Frequency Setting of Speed-Stage 7	0.00~400.00 0.0~1200.0 (when 00-31 = 1)	50.00	Hz	O	O	O	O	O	-	*1
06-08	Frequency Setting of Speed-Stage 8	0.00~400.00 0.0~1200.0 (when 00-31 = 1)	5.00	Hz	O	O	O	O	O	-	*1
06-09	Frequency Setting of Speed-Stage 9	0.00~400.00 0.0~1200.0 (when 00-31 = 1)	5.00	Hz	O	O	O	O	O	-	*1
06-10	Frequency Setting of Speed-Stage 10	0.00~400.00 0.0~1200.0 (when 00-31 = 1)	5.00	Hz	O	O	O	O	O	-	*1

Group 06: Automatic Program Operation Parameters

Code	Parameter Name	Setting Range	Default	Unit	Control mode						Attribute
					V/F	V/F +PG	SLV	SV	PM SV	PM SLV	
06-11	Frequency Setting of Speed-Stage 11	0.00~400.00 0.0~1200.0 (when 00-31 = 1)	5.00	Hz	O	O	O	O	O	-	*1
06-12	Frequency Setting of Speed-Stage 12	0.00~400.00 0.0~1200.0 (when 00-31 = 1)	5.00	Hz	O	O	O	O	O	-	*1
06-13	Frequency Setting of Speed-Stage 13	0.00~400.00 0.0~1200.0 (when 00-31 = 1)	5.00	Hz	O	O	O	O	O	-	*1
06-14	Frequency Setting of Speed-Stage 14	0.00~400.00 0.0~1200.0 (when 00-31 = 1)	5.00	Hz	O	O	O	O	O	-	*1
06-15	Frequency Setting of Speed-Stage 15	0.00~400.00 0.0~1200.0 (when 00-31 = 1)	5.00	Hz	O	O	O	O	O	-	*1
06-16	Operation Time Setting of Speed-Stage 0	0.0~6000.0	0.0	s	O	O	O	X	X	-	*1
06-17	Operation Time Setting of Speed-Stage 1	0.0~6000.0	0.0	s	O	O	O	X	X	-	*1
06-18	Operation Time Setting of Speed-Stage 2	0.0~6000.0	0.0	s	O	O	O	X	X	-	*1
06-19	Operation Time Setting of Speed-Stage 3	0.0~6000.0	0.0	s	O	O	O	X	X	-	*1
06-20	Operation Time Setting of Speed-Stage 4	0.0~6000.0	0.0	s	O	O	O	X	X	-	*1
06-21	Operation Time Setting of Speed-Stage 5	0.0~6000.0	0.0	s	O	O	O	X	X	-	*1
06-22	Operation Time Setting of Speed-Stage 6	0.0~6000.0	0.0	s	O	O	O	X	X	-	*1
06-23	Operation Time Setting of Speed-Stage 7	0.0~6000.0	0.0	s	O	O	O	X	X	-	*1
06-24	Operation Time Setting of Speed-Stage 8	0.0~6000.0	0.0	s	O	O	O	X	X	-	*1
06-25	Operation Time Setting of Speed-Stage 9	0.0~6000.0	0.0	s	O	O	O	X	X	-	*1
06-26	Operation Time Setting of Speed-Stage 10	0.0~6000.0	0.0	s	O	O	O	X	X	-	*1
06-27	Operation Time Setting of Speed-Stage 11	0.0~6000.0	0.0	s	O	O	O	X	X	-	*1
06-28	Operation Time Setting of Speed-Stage 12	0.0~6000.0	0.0	s	O	O	O	X	X	-	*1
06-29	Operation Time Setting of Speed-Stage 13	0.0~6000.0	0.0	s	O	O	O	X	X	-	*1
06-30	Operation Time Setting of Speed-Stage 14	0.0~6000.0	0.0	s	O	O	O	X	X	-	*1
06-31	Operation Time Setting of Speed-Stage 15	0.0~6000.0	0.0	s	O	O	O	X	X	-	*1
06-32	Operation Direction Selection of Speed-Stage 0	0: Stop 1: Forward 2: Reverse	0	-	O	O	O	X	X	-	
06-33	Operation Direction Selection of Speed-Stage 1	0: Stop 1: Forward 2: Reverse	0	-	O	O	O	X	X	-	
06-34	Operation Direction Selection of Speed-Stage 2	0: Stop 1: Forward 2: Reverse	0	-	O	O	O	X	X	-	

Group 06: Automatic Program Operation Parameters

Code	Parameter Name	Setting Range	Default	Unit	Control mode						Attribute
					V/F	V/F +PG	SLV	SV	PM SV	PM SLV	
06-35	Operation Direction Selection of Speed-Stage 3	0: Stop 1: Forward 2: Reverse	0	-	O	O	O	X	X	-	
06-36	Operation Direction Selection of Speed-Stage 4	0: Stop 1: Forward 2: Reverse	0	-	O	O	O	X	X	-	
06-37	Operation Direction Selection of Speed-Stage 5	0: Stop 1: Forward 2: Reverse	0	-	O	O	O	X	X	-	
06-38	Operation Direction Selection of Speed-Stage 6	0: Stop 1: Forward 2: Reverse	0	-	O	O	O	X	X	-	
06-39	Operation Direction Selection of Speed-Stage 7	0: Stop 1: Forward 2: Reverse	0	-	O	O	O	X	X	-	
06-40	Operation Direction Selection of Speed-Stage 8	0: Stop 1: Forward 2: Reverse	0	-	O	O	O	X	X	-	
06-41	Operation Direction Selection of Speed-Stage 9	0: Stop 1: Forward 2: Reverse	0	-	O	O	O	X	X	-	
06-42	Operation Direction Selection of Speed-Stage 10	0: Stop 1: Forward 2: Reverse	0	-	O	O	O	X	X	-	
06-43	Operation Direction Selection of Speed-Stage 11	0: Stop 1: Forward 2: Reverse	0	-	O	O	O	X	X	-	
06-44	Operation Direction Selection of Speed-Stage 12	0: Stop 1: Forward 2: Reverse	0	-	O	O	O	X	X	-	
06-45	Operation Direction Selection of Speed-Stage 13	0: Stop 1: Forward 2: Reverse	0	-	O	O	O	X	X	-	
06-46	Operation Direction Selection of Speed-Stage 14	0: Stop 1: Forward 2: Reverse	0	-	O	O	O	X	X	-	
06-47	Operation Direction Selection of Speed-Stage 15	0: Stop 1: Forward 2: Reverse	0	-	O	O	O	X	X	-	

Group 07: Start /Stop Parameters

Code	Parameter Name	Setting Range	Default	Unit	Control mode						Attribute
					V/F	V/F +PG	SLV	SV	PM SV	PM SLV	
07-00	Momentary Power Loss/Fault Restart Selection	0: Disable	0	-	O	O	O	O	O	-	
		1: Enable									
07-01	Fault Auto-Restart Time	0~7200	0	s	O	O	O	O	O	-	
07-02	Number of Fault Auto-Restart Attempts	0~10	0	-	O	O	O	O	O	-	

Group 07: Start /Stop Parameters

Code	Parameter Name	Setting Range	Default	Unit	Control mode						Attribute
					V/F	V/F +PG	SLV	SV	PM SV	PM SLV	
07-03 ~ 07-05	Reserved										
07-06	DC Injection Braking Starting Frequency	0.0~10.0	0.5	Hz	O	O	O	O	X	-	
07-07	DC Injection Braking Current	0~100	50	%	O	O	O	O	X	-	
07-08	DC Injection Braking Time at Stop	0.00~100.00	0.50	s	O	O	O	O	X	-	
07-09	Stop Mode Selection	0: Deceleration to Stop	0	-	O	O	O	O	O	-	
		1: Coast to Stop									
		2: DC Braking Stop in All Fields									
		3: Coast to Stop with Timer									
07-10 ~ 07-12	Reserved										
07-13	Low voltage Detection Level	200V: 150~210	190	V	O	O	O	O	O	-	
		400V: 300~420	380								
07-14	Pre-excitation Time	0.00~10.00	2.00	s	X	X	O	X	X	-	
07-15	Pre-excitation Level	50~200	100	%	X	X	O	X	X	-	
07-16	DC Injection Braking Time at Start	0.00~100.00	0.00	s	O	O	O	O	O	-	
07-17	Reserved										
07-18	Minimum Base block Time	0.1~5.0	-	Sec	O	O	O	X	X	-	
07-19	Direction-Detection Speed Search Operating Current	0~100	50	%	O	X	O	X	X	-	
07-20	Speed Search Operating Current	0~100	20	%	O	X	O	X	X	-	
07-21	Integral Time of Speed Searching	0.1~10.0	2.0	Sec	O	X	O	X	X	-	
07-22	Delay Time of Speed Searching	0.0~20.0	0.2	Sec	O	O	O	O	O	-	
07-23	Voltage Recovery Time	0.1~5.0	2.0	Sec	O	O	O	O	O	-	
07-24	Direction-Detection Speed Search Selection	0: Disable	0	-	O	O	O	X	X	-	
		1: Enable									
07-25	Low Voltage Detection Time	0.00~1.00	0.02	Sec	O	O	O	O	O	-	
07-26	SLV Speed Search Function	0: Enable	0	-	X	X	O	X	X	-	
		1: Disable									
07-27	Start Selection after Fault during SLV Mode	0: Start with speed search	0	-	X	X	O	X	X	-	
		1: Normal start									
07-28	Start after External Base Block	0: Start with speed search	0	-	O	X	O	X	X	-	
		1: Normal start									

Group 08: Protection Parameters											
Code	Parameter Name	Setting Range	Default	Unit	Control mode						Attribute
					V/F	V/F +PG	SLV	SV	PM SV	PM SLV	
08-00	Stall Prevention Function	xxx0b: Stall prevention is enabled in acceleration.	0000b	-	0	0	0	0	0	-	
		xxx1b: Stall prevention is disabled in acceleration.									
		xx0xb: Stall prevention is enabled in deceleration.									
		xx1xb: Stall prevention is disabled in deceleration.									
		x0xxb: Stall prevention is enabled in operation									
		x1xxb: Stall prevention is disabled in operation									
		0xxxb: Stall prevention in operation is based on deceleration time of speed-stage 1.									
		1xxxb: Stall prevention in operation is based on deceleration time of speed-stage 2.									
08-01	Stall Prevention Level in Acceleration	30~200	HD:150 ND:120	%	0	0	0	X	X	-	
08-02	Stall Prevention Level in Deceleration	200V: 330~410	395	V	0	0	0	0	X	-	
		400V: 660~820	790								
08-03	Stall Prevention Level in Operation	30~200	HD:160 ND:120	%	0	0	0	X	X	-	
08-04	Reserved										
08-05	Selection for Motor Overload Protection (OL1)	xxx0b: Overload Protection is disabled.	0001b	-	0	0	0	0	0	-	
		xxx1b: Overload Protection is enabled.									
		xx0xb: Cold Start of Motor Overload									
		xx1xb: Hot Start of Motor Overload									
		x0xxb: Standard Motor									
		x1xxb: Inverter Duty Motor									
		0xxxb: Reserved									
1xxxb: Reserved											
08-06	Start-up Mode of Overload Protection Operation (OL1)	0: Stop Output after Overload Protection	0	-	0	0	0	0	0	-	
		1: Continuous Operation after Overload Protection.									
08-07	Reserved										
08-08	Automatic Voltage Regulation (AVR)	0: Enable	0	-	0	0	0	0	0	-	
		1: Disable									

Group 08: Protection Parameters												
Code	Parameter Name	Setting Range	Default	Unit	Control mode						Attribute	
					V/F	V/F +PG	SLV	SV	PM SV	PM SLV		
08-09	Selection of Input Phase Loss Protection	0: Disable	0	-	0	0	0	0	0	-		
		1: Enable										
08-10	Selection of Output Phase Loss Protection	0: Disable	0	-	0	0	0	0	0	-		
		1: Enable										
08-11 ~ 08-12	Reserved											
08-13	Selection of Over-Torque Detection	0: Over-Torque Detection is Disabled.	0	-	0	0	0	0	0	0	-	
		1: Start to Detect when Reaching the Set Frequency.										
		2: Start to Detect when the Operation is Begun.										
08-14	Selection of Over-Torque Operation	0: Deceleration to Stop when Over Torque is Detected.	0	-	0	0	0	0	0	0	-	
		1: Display Warning when Over Torque is Detected. Go on Operation.										
		2: Coast to Stop when Over Torque is Detected										
08-15	Level of Over-Torque Detection	0~300	150	%	0	0	0	0	0	0	-	
08-16	Time of Over-Torque Detection	0.0~10.0	0.1	Sec	0	0	0	0	0	0	-	
08-17	Selection of Low-Torque Detection	0: Low-Torque Detection is Disabled.	0	-	0	0	0	0	0	0	-	
		1: Start to Detect when Reaching the Set Frequency.										
		2: Start to Detect when the Operation is Begun.										
08-18	Selection of Low-Torque Operation	0: Deceleration to Stop when Low Torque is Detected.	0	-	0	0	0	0	0	0	-	
		1: Display Warning when Low Torque is Detected. Go on Operation.										
		2: Coast to Stop when Low Torque is Detected										
08-19	Level of Low-Torque Detection	0~300	30	%	0	0	0	0	0	0	-	
08-20	Time of Low-Torque Detection	0.0~10.0	0.1	Sec	0	0	0	0	0	0	-	
08-21	Limit of Stall Prevention in Acc over Base Speed	0~100	50	%	0	0	0	X	X	-		
08-22	Stall Prevention Detection Time in Operation	2~100	100	ms	0	0	0	X	X	-		
08-23	Ground Fault (GF) Selection	0: Disable	0	-	0	0	0	0	0	0	-	
		1: Enable										

Group 08: Protection Parameters											
Code	Parameter Name	Setting Range	Default	Unit	Control mode						Attribute
					V/F	V/F +PG	SLV	SV	PM SV	PM SLV	
08-24	External Fault Operation Selection	0: Deceleration to Stop	0	-	0	0	0	0	0	-	
		1: Coast to Stop									
		2: Continuous Operation									
08-25	Detection Selection of External Fault	0: Immediately Detect when the Power is Supplied.	0	-	0	0	0	0	0	-	
		1: Start to Detect when the Operation is Started.									
08-26 ~ 08-30	Reserved										

Information
provided by
EMAG
Tel: 01902 601403
www.emag-ltd.co.uk

Group 09: Communication Parameters											
Code	Parameter Name	Setting Range	Default	Unit	Control mode						Attribute
					V/F	V/F +PG	SL V	SV	PM SV	PM SLV	
09-00	INV Communication Station Address	1~31	1	-	0	0	0	0	0	-	*2
09-01	Reserved										
09-02	Baud Rate Setting (bps)	0: 1200	3	-	0	0	0	0	0	-	*2
		1: 2400									
		2: 4800									
		3: 9600									
		4: 19200									
5: 38400											
09-03	Stop Bit Selection	0: 1 Stop Bit	0	-	0	0	0	0	0	-	*2
		1: 2 Stop Bit									
09-04	Parity Selection	0: No Parity	0	-	0	0	0	0	0	-	*2
		1: Even Bit									
		2: Odd Bit									
09-05	Reserved										
09-06	Communication Error Detection Time	0.0~25.5	0.0	S	0	0	0	0	0	-	
09-07	Fault Stop Selection	0: Deceleration to Stop Based on Deceleration Time 1 when Communication Fault Occurs.	3	-	0	0	0	0	0	-	
		1: Coast to Stop when Communication Fault Occurs.									
		2: Deceleration to Stop Based on Deceleration Time 2 when Communication Fault Occurs.									
		3: Keep Operating when Communication Fault Occurs.									
09-08	Comm. Fault Tolerance Count	1~20	1	-	0	0	0	0	0	-	
09-09	Waiting Time	5~65	5	ms	0	0	0	0	0	-	

Group 10: PID Parameters											
Code	Parameter Name	Setting Range	Default	Unit	Control mode						Attribute
					V/F	V/F +PG	SLV	SV	PM SV	PM SLV	
10-00	PID Target Value Source Setting	1: AI1 given	1	-	0	0	0	0	0	-	
		2: AI2 given									
		3: Reserved									
		4:10-02 given									
10-01	PID Feedback Value Source Setting	1: AI1 given	2	-	0	0	0	0	0	-	
		2: AI2 given									
		3: Reserved									
10-02	PID Target Value	0.0~100.0	0.0	%	0	0	0	0	0	-	
10-03	PID Control Mode	xxx0b: PID Disable	0000b	-	0	0	0	0	0	-	
		xxx1b: PID Enable									
		xx0xb: PID Positive Characteristic									
		xx1xb: PID Negative Characteristic									
		x0xxb: PID Error Value of D Control									
		x1xxb: PID Feedback Value of D Ctrl									
		0xxxb: PID Output									
		1xxxb: PID Output + Target Value									
10-04	Feedback Gain	0.01~10.00	1.00	-	0	0	0	0	0	-	*1
10-05	Proportional Gain (P)	0.00~10.00	1.00	-	0	0	0	0	0	-	*1
10-06	Integral Time (I)	0.0~100.0	1.00	s	0	0	0	0	0	-	*1
10-07	Differential Time (D)	0.00~10.00	0.00	s	0	0	0	0	0	-	*1
10-08	Reserved										
10-09	PID Bias	-100.0~100.0	0	%	0	0	0	0	0	-	*1
10-10	PID Primary Delay Time	0.00~10.00	0.00	s	0	0	0	0	0	-	*1
10-11	PID Feedback Loss Detection Selection	0: Disable	0	-	0	0	0	0	0	-	
		1: Warning									
		2: Fault									
10-12	PID Feedback Loss Det. Lev.	0~100	0	%	0	0	0	0	0	-	
10-13	PID Feedback Loss Det. Time	0.0~10.0	1.0	s	0	0	0	0	0	-	
10-14	PID Integral Limit	0.0~100.0	100.0	%	0	0	0	0	0	-	*1
10-15 ~ 10-16	Reserved										
10-17	Start Frequency of PID Sleep	0.00~180.00	0.00	Hz	0	0	0	0	0	-	
10-18	Delay Time of PID Sleep	0.0~255.5	0.0	s	0	0	0	0	0	-	
10-19	Frequency of PID Waking up	0.00~180.00	0.00	Hz	0	0	0	0	0	-	
10-20	Delay Time of PID Waking up	0.0~255.5	0.0	s	0	0	0	0	0	-	
10-21 ~ 10-22	Reserved										

Group 10: PID Parameters											
Code	Parameter Name	Setting Range	Default	Unit	Control mode						Attribute
					V/F	V/F +PG	SLV	SV	PM SV	PM SLV	
10-23	PID Limit	0.00~100.0	100.0	%	0	0	0	0	0	-	*1
10-24	PID Output Gain	0.0~25.0	1.0	-	0	0	0	0	0	-	
10-25	PID Reversal Output Selection	0: No Allowing Reversal Output	0	-	0	0	0	0	0	-	
		1: Allow Reversal Output									
10-26	PID Target Acceleration/Deceleration Time	0.0~25.5	0.0	s	0	0	0	0	0	-	
10-27	PID Feedback Display Bias	-99.99~99.99	0.00	-	0	0	0	0	0	-	
10-28	PID Feedback Display Gain	0.00~100.00	100.00	-	0	0	0	0	0	-	
10-29	PID Sleep Selection	0: Disable	1	-	0	0	0	0	0	-	
		1: Enable									
		2: set by DI									

Group 11: Auxiliary Parameters											
Code	Parameter Name	Setting Range	Default	Unit	Control mode						Attribute
					V/F	V/F +PG	SLV	SV	PM SV	PM SLV	
11-00	Direction Lock Selection	0: Allow Forward and Reverse Rotation	0	-	0	0	0	0	0	-	
		1: Only Allow Forward Rotation									
		2: Only Allow Reverse Rotation									
11-01	Carrier frequency	0: Carrier Output Frequency Tuning 1: Reserved 2~16: KHz	Determined by horsepower (HP) value	-	0	0	0	0	X	-	
11-02	Soft PWM Function Selection	0: Disable	0	-	0	0	0	0	0	-	
		1: Enable									
11-03	Automatic carrier lowering selection	0: Disable	0	-	0	0	X	X	X	-	
		1: Enable									
11-04	S-curve Time Setting at the Start of Acceleration	0.00~2.50	0.20	s	0	0	0	0	0	-	
11-05	S-curve Time Setting at the Start of Acceleration	0.00~2.50	0.20	s	0	0	0	0	0	-	
11-06	S-curve Time Setting at the Start of Deceleration	0.00~2.50	0.20	s	0	0	0	0	0	-	
11-07	S-curve Time Setting at the Start of Deceleration	0.00~2.50	0.20	s	0	0	0	0	0	-	
11-08	Jump Frequency 1	0.0~400.0 0.0~1200.0 (when 00-31 = 1)	0.0	Hz	0	0	0	0	0	-	
11-09	Jump Frequency 2	0.0~400.0 0.0~1200.0 (when 00-31 = 1)	0.0	Hz	0	0	0	0	0	-	
11-10	Jump Frequency 3	0.0~400.0 0.0~1200.0 (when 00-31 = 1)	0.0	Hz	0	0	0	0	0	-	

Group 11: Auxiliary Parameters											
Code	Parameter Name	Setting Range	Default	Unit	Control mode						Attribute
					V/F	V/F+PG	SLV	SV	PM SV	PM SLV	
11-11	Jump Frequency Width	0.0~25.5	1.0	Hz	O	O	O	O	O	-	
11-12	Manual Energy Saving Gain	0~100	80	%	O	O	X	X	X	-	
11-13 ~ 11-17	Reserved										
11-18	Manual Energy Saving Frequency	0.00~400.00 0.0~1200.0 (when 00-31 = 1)	0.00	Hz	O	O	X	X	X	-	
11-19	Automatic Energy Saving Function	0: Automatic energy saving is disabled.	0	-	O	X	X	X	X	-	
		1: Automatic energy saving is enabled.			O	X	X	X	X	-	
11-20	Filter Time of Automatic Energy Saving	0~200	140	ms	O	X	X	X	X	-	
11-21	Voltage Upper Limit of Energy Saving Tuning	0~100	100	%	O	X	X	X	X	-	
11-22	Adjustment Time of Automatic Energy Saving	0~5000	20	ms	O	X	X	X	X	-	*1
11-23	Detection Level of Automatic Energy Saving	0~100	10	%	O	X	X	X	X	-	
11-24	Coefficient of Automatic Energy Saving	0.00~655.35	-	-	O	X	X	X	X	-	
11-25 ~ 11-28	Reserved										
11-29	Auto De-rating Selection	0: Disable	0	-	O	X	X	X	X	-	
		1: Enable									
11-30	Variable Carrier Frequency Max. Limit	2~16	-	KHz	O	O	X	X	X	-	
11-31	Variable Carrier Frequency Min. Limit	2~16	-	KHz	O	O	X	X	X	-	
11-32	Variable Carrier Frequency Proportional Gain	00~99	00	-	O	O	X	X	X	-	
11-33	DC Voltage Filter Rise Amount	0.1~10.0	0.1	Vdc	O	O	X	X	X	-	*1
11-34	DC Voltage Filter Fall Amount	0.1~10.0	5.0	Vdc	O	O	X	X	X	-	*1
11-35	DC Voltage Filter Dead band Level	0.0~99.0	10.0	Vdc	O	O	X	X	X	-	*1
11-36	Frequency Gain of OV Prevention	0.000~1.000	0.050	-	O	O	X	X	X	-	*1
11-37	Frequency Limit of OV Prevention	0.00~10.00	5.00	Hz	O	O	X	X	X	-	
11-38	Deceleration Start Voltage of OV Prevention	200V: 200~400V	300	V	O	O	X	X	X	-	
		400V: 400~800V	700								



Group 11: Auxiliary Parameters

Code	Parameter Name	Setting Range	Default	Unit	Control mode						Attribute
					V/F	V/F+PG	SLV	SV	PM SV	PM SLV	
11-39	Deceleration Stop Voltage of OV Prevention	200V: 300~400V	350	V	O	O	X	X	X	-	
		400V: 600~800V	750								
11-40	OV Prevention Selection	0: Disable 1: Enable	0	-	O	O	X	X	X	-	
11-41	Selection of Detecting the Disappearance of Reference Frequency	0: When Referring to Frequency Disappears, the Deceleration Stops	0	-	O	O	O	O	O	-	
		1: When Referring to Frequency Disappears, Operation will be Based on the Proportion of Reference Frequency x 11-42									
11-42	Disappearance Level of Reference Frequency	0.0~100.0	80.0	%	O	O	O	O	O	-	
11-43	Hold Frequency at Start	0.0~400.0	0.0	Hz	O	O	O	O	O	-	
11-44	Frequency Hold Time at Start	0.0~10.0	0.0	s	O	O	O	O	O	-	
11-45	Hold Frequency at Stop	0.0~400.0	0.0	Hz	O	O	O	O	O	-	
11-46	Frequency Hold Time at Stop	0.0~10.0	0.0	s	O	O	O	O	O	-	
11-47	KEB Deceleration Time	0.0~25.5	0.0	s	O	O	X	X	X	-	*1
11-48	KEB Detection Level	200V: 190~210	200	V	O	O	X	X	X	-	
		400V: 380~420	400								
11-49	Zero-servo Gain	0~50	5	-	X	X	X	O	O	-	
11-50	Zero-servo Count	0~4096	12	-	X	X	X	O	O	-	
11-51	Braking Selection of Zero Speed	0: Disable	0	-	O	X	X	X	X	-	
		1: Enable									
11-52	Droop Control Level	0.0~100.0%	0.0	%	X	X	X	O	O	-	*1
11-53	Droop Control Delay	0.01~2.00	0.2	s	X	X	X	O	O	-	*1
11-54	Output kWh Initialization	0: Don't Clear Output kWh	0	-	O	O	O	O	O	-	*1
		1: Clear Output kWh									
11-55	STOP Key Selection	0: Stop Key is Disabled when the Operation Command is not Provided by Operator.	1	-	O	O	O	O	O	-	
		1: Stop Key is Enabled when the Operation Command is not Provided by Operator.									

Group 11: Auxiliary Parameters												
Code	Parameter Name	Setting Range	Default	Unit	Control mode						Attribute	
					V/F	V/F+PG	SLV	SV	PM SV	PM SLV		
11-56	UP/DOWN Selection	0: When Operator's UP/DOWN is Disabled, it will be Enabled if Press ENTER after Frequency Modification.	0	-	0	0	0	0	0	0	-	
		1: When Operator's UP/DOWN is Enabled, it will be Enabled after Frequency Modification.										
11-57	Reserved											
11-58	Record Reference Frequency	0: Disable	0	-	0	0	0	0	0	0	-	*1
		1: Enable										

Group 12: Monitoring Parameters												
Code	Parameter Name	Setting Range	Default	Unit	Control mode						Attribute	
					V/F	V/F+PG	SLV	SV	PM SV	PM SLV		
12-00	Display Screen Selection (LED)	00000~77777 From the leftmost bit, it displays the screen when press DSP key in order. 0: no display 1: Output Current 2: Output Voltage 3: DC Bus Voltage 4: Heatsink Temperature* 5: PID Feedback 6: AI1 Value 7: AI2 Value	00000	-	0	0	0	0	0	0	-	
12-01	PID Feedback Display Mode (LED)	0: Display the Feedback Value by Integer (xxx)	0		0	0	0	0	0	0	-	
		1: Display the Feedback Value by the Value with One Decimal Place (xx.x)										
		2: Display the Feedback Value by the Value with Two Decimal Places (x.xx)										
12-02	PID Feedback Display Unit Setting (LED)	0: xxxxx (no unit)	0		0	0	0	0	0	0	-	
		1: xxxPb (pressure)										
		2: xxxFL (flow)										
12-03 ~ 12-04	Reserved											

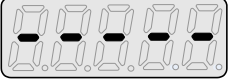
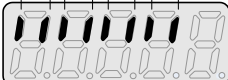
Group 12: Monitoring Parameters

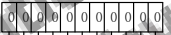
Code	Parameter Name	Setting Range	Default	Unit	Control mode						Attribute
					V/F	V/F +PG	SLV	SV	PM SV	PM SLV	
12-05	Status Display of Digital Input Terminal (LED / LCD)	<p>LED display is shown as below no input</p>  <p>correspondences to input and output</p> <p>S1 S2 S3 S4 S5 S6 S7 S8</p>   <p>R1 R2 DO1</p> <p>LCD display is shown as below</p>  <p>0 : OPEN 1 : CLOSE</p> <ul style="list-style-type: none"> Input Terminal(S8) Input Terminal(S7) Input Terminal(S6) Input Terminal(S5) Input Terminal(S4) Input Terminal(S3) Input Terminal(S2) Input Terminal(S1) Output Terminal(DO1) Output Terminal(R2) Output Terminal(R1) 	-	-	0	0	0	0	0	-	
12-06 ~ 12-10	Reserved										
12-11	Output Current of Current Fault	Display the output current of current fault	-	A	0	0	0	0	0	-	
12-12	Output Voltage of Current Fault	Display the output voltage of current fault	-	V	0	0	0	0	0	-	
12-13	Output Frequency of Current Fault	Display the output frequency of current fault	-	Hz	0	0	0	0	0	-	
12-14	DC Voltage of Current Fault	Display the DC voltage of current fault	-	V	0	0	0	0	0	-	
12-15	Frequency Command of Current Fault	Display the frequency command of current fault	-	Hz	0	0	0	0	0	-	
12-16	Frequency Command	If LED enters this parameter, it only allows monitoring frequency command.	-	Hz	0	0	0	0	0	-	
12-17	Output Frequency	Display the current output frequency	-	Hz	0	0	0	0	0	-	
12-18	Output Current	Display the current output current	-	A	0	0	0	0	0	-	
12-19	Output Voltage	Display the current output voltage	-	V	0	0	0	0	0	-	
12-20	DC Voltage (Vdc)	Display the current DC voltage	-	V	0	0	0	0	0	-	

Group 12: Monitoring Parameters

Code	Parameter Name	Setting Range	Default	Unit	Control mode						Attribute
					V/F	V/F +PG	SLV	SV	PM SV	PM SLV	
12-21	Output Power (kw)	Display the current output power	-	kW	0	0	0	0	0	-	
12-22	Motor's Rotation Speed (rpm)	Display motor's current rotation speed in VF/SLV mode Motor's rotation speed = output power x(120/motor's pole number) In PG/SV mode, motor's rotation speed is calculated by feedback frequency. Max limit is 65535	-	rpm	0	0	0	0	0	-	
12-23	Output Power Factor (Pfo)	Display the current output power factor	-	-	0	0	0	0	0	-	
12-24	Control Mode	Display control mode 0 : VF 1 : PG 2 : SLV (Sensorless Vector) 3 : SV (Sensor Vector) 4 : PSV (PM SV)	-	-	0	0	0	0	0	-	
12-25	AI1 Input	Display the current AI1 input (-10V corresponds to -100%, 10V corresponds to 100%.)	-	%	0	0	0	0	0	-	
12-26	AI2 Input	Display the current AI2 input (0V or 4mA corresponds to 0%, 10V or 20mA corresponds to 100%)	-	%	0	0	0	0	0	-	
12-27	Torque Command	Display the current torque command (100% corresponds to motor torque)	-	%	X	X	0	0	0	-	
12-28	Motor Torque Current (Iq)	Display the current q-axis current	-	%	X	X	0	0	0	-	
12-29	Motor Excitation Current (Id)	Display the current d-axis current	-	%	X	X	0	0	0	-	
12-30	ASR Deviation	Display deviation of speed controller (speed command - speed feedback) (100% corresponds to the maximum frequency set by 01-02)	-	%	X	0	X	0	0	-	
12-31	Reserved										
12-32	ASR Output	Display output value of speed controller (100% corresponds to the maximum frequency set by 01-02)	-	%	X	0	X	0	0	-	
12-33	PG Feedback	Display feedback's speed value of speed controller (100% corresponds to the maximum frequency set by 01-02)	-	%	X	0	X	0	0	-	

Group 12: Monitoring Parameters

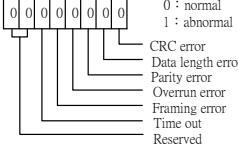
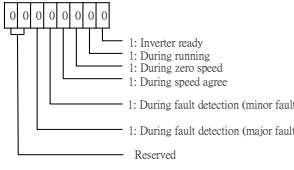
Code	Parameter Name	Setting Range	Default	Unit	Control mode						Attribute
					V/F	V/F+PG	SLV	SV	PM SV	PM SLV	
12-34	Reserved										
12-35	Zero-servo Pulse	When display SV position mode, the position error pulse number of the zero speed servo (the pulse number of a circle is four times of set values of 20-27)	-	Pulse	X	X	X	O	O	-	
12-36	PID Input	Display input error of the PID controller (PID target value - PID feedback) (100% corresponds to the maximum frequency set by 01-02 or 01-16)	0.01	%	O	O	O	O	O	-	
12-37	PID Output	Display output of the PID controller (100% corresponds to the maximum frequency set by 01-02 or 01-16)	-	%	O	O	O	O	O	-	
12-38	PID Setting	Display the target value of the PID controller (100% corresponds to the maximum frequency set by 01-02 or 01-16)	-	%	O	O	O	O	O	-	
12-39	PID Feedback	Display the feedback value of the PID controller (100% corresponds to the maximum frequency set by 01-02 or 01-16)	-	%	O	O	O	O	O	-	
12-40	Motor's Cumulative Output Energy	Display motor's cumulative output energy	-	KWHr	O	O	O	O	O	-	
12-41	Heatsink Temperature*	Display the heatsink temperature of IGBT temperature.	-	°C	O	O	O	O	O	-	
12-42	RS-485 Error Code	Display the status of RS-485 	-	-	O	O	O	O	O	-	
12-43	Inverter Status		-	-	O	O	O	O	O	-	
12-44	Pulse Input Frequency	Display the frequency value of pulse input	-	Hz	O	O	O	O	O	-	
12-45	Recent Fault Message	Display current fault message	-	-	O	O	O	O	O	-	

Group 12: Monitoring Parameters

Code	Parameter Name	Setting Range	Default	Unit	Control mode						Attribute
					V/F	V/F+PG	SLV	SV	PM SV	PM SLV	
12-46	Previous Fault Message	Display previous fault message	-	-	0	0	0	0	0	-	
12-47	Previous Two Fault Messages	Display previous two fault messages	-	-	0	0	0	0	0	-	
12-48	Previous Three Fault Messages	Display previous three fault messages	-	-	0	0	0	0	0	-	
12-49	Previous Four Fault Messages	Display previous four fault messages	-	-	0	0	0	0	0	-	
12-50	DIO Status of Current Fault	Display the DI/DO status of current fault Description is similar to 12-05	-	-	0	0	0	0	0	-	
12-51	Inverter Status of Current Fault	Display the inverter status of current fault Description is similar to 12-43	-	-	0	0	0	0	0	-	
12-52	Trip Time 1 of Current Fault	Display the operation time of current fault, 12-53 is the days, while 12-52 is the total hours.	-	Hr	0	0	0	0	0	-	
12-53	Trip Time 2 of Current Fault		-	day	0	0	0	0	0	-	
12-54	Frequency Command of Previous Fault	Display frequency command of previous fault	-	Hz	0	0	0	0	0	-	
12-55	Output Frequency of Previous Fault	Display output frequency of previous fault	-	Hz	0	0	0	0	0	-	
12-56	Output Current of Previous Fault	Display output current of previous fault	-	A	0	0	0	0	0	-	
12-57	Output Voltage of Previous Fault	Display output voltage of previous fault	-	V	0	0	0	0	0	-	
12-58	DC Voltage of Previous Fault	Display DC voltage of previous fault	-	V	0	0	0	0	0	-	
12-59	DIO Status of Previous Fault	Display DI/DO status of previous fault Description is similar to 12-05	-	-	0	0	0	0	0	-	
12-60	Inverter Status of Previous Fault	Display inverter status of previous fault Description is similar to 12-43	-	-	0	0	0	0	0	-	
12-61	Trip Time 1 of Last Fault	Display the operation time of last time's fault, 12-62 is the days, while 12-61 is the total hours .	-	Hr	0	0	0	0	0	-	
12-62	Trip Time 2 of Last Fault		-	day	0	0	0	0	0	-	
12-63	Recent Warning Messages	Display the recent warning messages	-	-	0	0	0	0	0	-	
12-64	Previous Warning Message	Display the previous warning message	-	-	0	0	0	0	0	-	
12-65	Motor Start Angle	0~360	-	-	X	X	X	X	0	-	
12-66	Motor Actual Angle	0~360	-	-	X	X	X	X	0	-	

* A510 200V 50HP (and the above) and 400V 75HP (and the above) don't support heatsink temperature display function.

Group 13: Maintenance Parameters											
Code	Parameter Name	Setting Range	Default	Unit	Control mode						Attribute
					V/F	V/F+PG	SLV	SV	PM SV	PM SLV	
13-00	Inverter Capacity Selection	----	-	-	0	0	0	0	0	-	*4
13-01	Software Version	----	-	-	0	0	0	0	0	-	*4
13-02	Reserved										
13-03	Cumulative Operation Hours 1	0~23	-	hr	0	0	0	0	0	-	*4
13-04	Cumulative Operation Hours 2	0~65535	-	day	0	0	0	0	0	-	*4
13-05	Selection of Cumulative Operation Time	0: Cumulative time in power on	0	-	0	0	0	0	0	-	*1
		1: Cumulative time in operation									
13-06	Parameters Locked	0: Parameters are read-only except 13-06.	2	-	0	0	0	0	0	-	*1
		1: Reserved									
		2: All Parameters are Writable									
13-07	Parameter Password Function	0~9999	0	-	0	0	0	0	0	-	
13-08	Restore Factory Setting	0: No initialization	-	-	0	0	0	0	0	-	
		1: Reserved									
		2: 2 wire initialization (60Hz) (220/440V)									
		3: 3 wire initialization (60Hz) (220/440V)									
		4: 2 wire initialization (50Hz) (230/415V)									
		5: 3 wire initialization (50Hz) (230/415V)									
		6: 2 wire initialization (50Hz) (200/380V)									
		7: 3 wire initialization (50Hz) (200/380V)									
8: PLC initialization											
Others: Reserved											
13-09	Fault History Clearance Function	0: No Clearing Fault History	0	-	0	0	0	0	0	-	*1
		1: Clear Fault History									

Group 14: PLC Setting Parameters

Code	Parameter Name	Setting Range	Default	Unit	Control mode						Attribute
					V/F	V/F +PG	SLV	SV	PM SV	PM SLV	
14-00	T1 Set Value 1	0~9999	0	-	0	0	0	0	0	-	
14-01	T1 Set Value 2 (Mode 7)	0~9999	0	-	0	0	0	0	0	-	
14-02	T2 Set Value 1	0~9999	0	-	0	0	0	0	0	-	
14-03	T2 Set Value 2 (Mode 7)	0~9999	0	-	0	0	0	0	0	-	
14-04	T3 Set Value 1	0~9999	0	-	0	0	0	0	0	-	
14-05	T3 Set Value 2 (Mode 7)	0~9999	0	-	0	0	0	0	0	-	
14-06	T4 Set Value 1	0~9999	0	-	0	0	0	0	0	-	
14-07	T4 Set Value 2 (Mode 7)	0~9999	0	-	0	0	0	0	0	-	
14-08	T5 Set Value 1	0~9999	0	-	0	0	0	0	0	-	
14-09	T5 Set Value 2 (Mode 7)	0~9999	0	-	0	0	0	0	0	-	
14-10	T6 Set Value 1	0~9999	0	-	0	0	0	0	0	-	
14-11	T6 Set Value 2 (Mode 7)	0~9999	0	-	0	0	0	0	0	-	
14-12	T7 Set Value 1	0~9999	0	-	0	0	0	0	0	-	
14-13	T7 Set Value 2 (Mode 7)	0~9999	0	-	0	0	0	0	0	-	
14-14	T8 Set Value 1	0~9999	0	-	0	0	0	0	0	-	
14-15	T8 Set Value 2 (Mode 7)	0~9999	0	-	0	0	0	0	0	-	
14-16	C1 Set Value	0~65535	0	-	0	0	0	0	0	-	
14-17	C2 Set Value	0~65535	0	-	0	0	0	0	0	-	
14-18	C3 Set Value	0~65535	0	-	0	0	0	0	0	-	
14-19	C4 Set Value	0~65535	0	-	0	0	0	0	0	-	
14-20	C5 Set Value	0~65535	0	-	0	0	0	0	0	-	
14-21	C6 Set Value	0~65535	0	-	0	0	0	0	0	-	
14-22	C7 Set Value	0~65535	0	-	0	0	0	0	0	-	
14-23	C8 Set Value	0~65535	0	-	0	0	0	0	0	-	
14-24	AS1 Set Value 1	0~65535	0	-	0	0	0	0	0	-	
14-25	AS1 Set Value 2	0~65535	0	-	0	0	0	0	0	-	
14-26	AS1 Set Value 3	0~65535	0	-	0	0	0	0	0	-	
14-27	AS2 Set Value 1	0~65535	0	-	0	0	0	0	0	-	
14-28	AS2 Set Value 2	0~65535	0	-	0	0	0	0	0	-	
14-29	AS2 Set Value 3	0~65535	0	-	0	0	0	0	0	-	
14-30	AS3 Set Value 1	0~65535	0	-	0	0	0	0	0	-	
14-31	AS3 Set Value 2	0~65535	0	-	0	0	0	0	0	-	
14-32	AS3 Set Value 3	0~65535	0	-	0	0	0	0	0	-	
14-33	AS4 Set Value 1	0~65535	0	-	0	0	0	0	0	-	
14-34	AS4 Set Value 2	0~65535	0	-	0	0	0	0	0	-	
14-35	AS4 Set Value 3	0~65535	0	-	0	0	0	0	0	-	
14-36	MD1 Set Value 1	0~65535	1	-	0	0	0	0	0	-	
14-37	MD1 Set Value 2	0~65535	1	-	0	0	0	0	0	-	
14-38	MD1 Set Value 3	0~65535	1	-	0	0	0	0	0	-	
14-39	MD2 Set Value 1	0~65535	1	-	0	0	0	0	0	-	
14-40	MD2 Set Value 2	0~65535	1	-	0	0	0	0	0	-	
14-41	MD2 Set Value 3	0~65535	1	-	0	0	0	0	0	-	
14-42	MD3 Set Value 1	0~65535	1	-	0	0	0	0	0	-	
14-43	MD3 Set Value 2	0~65535	1	-	0	0	0	0	0	-	
14-44	MD3 Set Value 3	0~65535	1	-	0	0	0	0	0	-	
14-45	MD4 Set Value 1	0~65535	1	-	0	0	0	0	0	-	
14-46	MD4 Set Value 2	0~65535	1	-	0	0	0	0	0	-	
14-47	MD4 Set Value 3	0~65535	1	-	0	0	0	0	0	-	

Group 15: PLC Monitoring Parameters

Code	Parameter Name	Setting Range	Default	Unit	Control mode						Attribute
					V/F	V/F +PG	SLV	SV	PM SV	PM SLV	
15-00	T1 Current Value1	0~9999	0	-	0	0	0	0	0	-	
15-01	T1 Current Value 2 (Mode7)	0~9999	0	-	0	0	0	0	0	-	
15-02	T2 Current Value 1	0~9999	0	-	0	0	0	0	0	-	
15-03	T2 Current Value 2 (Mode7)	0~9999	0	-	0	0	0	0	0	-	
15-04	T3 Current Value 1	0~9999	0	-	0	0	0	0	0	-	
15-05	T3 Current Value 2 (Mode7)	0~9999	0	-	0	0	0	0	0	-	
15-06	T4 Current Value 1	0~9999	0	-	0	0	0	0	0	-	
15-07	T4 Current Value 2 (Mode7)	0~9999	0	-	0	0	0	0	0	-	
15-08	T5 Current Value 1	0~9999	0	-	0	0	0	0	0	-	
15-09	T5 Current Value 2 (Mode7)	0~9999	0	-	0	0	0	0	0	-	
15-10	T6 Current Value 1	0~9999	0	-	0	0	0	0	0	-	
15-11	T6 Current Value 2 (Mode7)	0~9999	0	-	0	0	0	0	0	-	
15-12	T7 Current Value 1	0~9999	0	-	0	0	0	0	0	-	
15-13	T7 Current Value 2 (Mode7)	0~9999	0	-	0	0	0	0	0	-	
15-14	T8 Current Value 1	0~9999	0	-	0	0	0	0	0	-	
15-15	T8 Current Value 2 (Mode7)	0~9999	0	-	0	0	0	0	0	-	
15-16	C1 Current Value	0~65535	0	-	0	0	0	0	0	-	
15-17	C2 Current Value	0~65535	0	-	0	0	0	0	0	-	
15-18	C3 Current Value	0~65535	0	-	0	0	0	0	0	-	
15-19	C4 Current Value	0~65535	0	-	0	0	0	0	0	-	
15-20	C5 Current Value	0~65535	0	-	0	0	0	0	0	-	
15-21	C6 Current Value	0~65535	0	-	0	0	0	0	0	-	
15-22	C7 Current Value	0~65535	0	-	0	0	0	0	0	-	
15-23	C8 Current Value	0~65535	0	-	0	0	0	0	0	-	
15-24	AS1 Current Value	0~65535	0	-	0	0	0	0	0	-	
15-25	AS2 Current Value	0~65535	0	-	0	0	0	0	0	-	
15-26	AS3 Current Value	0~65535	0	-	0	0	0	0	0	-	
15-27	AS4 Current Value	0~65535	0	-	0	0	0	0	0	-	
15-28	MD1 Current Value	0~65535	0	-	0	0	0	0	0	-	
15-29	MD2 Current Value	0~65535	0	-	0	0	0	0	0	-	
15-30	MD3 Current Value	0~65535	0	-	0	0	0	0	0	-	
15-31	MD4 Current Value	0~65535	0	-	0	0	0	0	0	-	
15-32	TD Current Value	0~65535	0	-	0	0	0	0	0	-	

Group 16: LCD Function Parameters

Code	Parameter Name	Setting Range	Default	Unit	Control mode						Attribute
					V/F	V/F +PG	SLV	SV	PM SV	PM SLV	
16-00	Main Screen Monitoring	5~67 when using LCD to operate, the monitored item displays in the first line. (default is frequency command)	16	-	0	0	0	0	0	-	*1
16-01	Sub-Screen Monitoring 1	5~67 when using LCD to operate, the monitored item displays in the second line. (default is output frequency)	17	-	0	0	0	0	0	-	*1
16-02	Sub-Screen Monitoring 2	5~67 when using LCD to operate, the monitored item displays in the third line. (default is output current)	18	-	0	0	0	0	0	-	*1
16-03	Display Unit	0~39999 Determine the display way and unit of frequency command	0	-	0	0	0	0	0	-	
		0: Frequency display unit is 0.01Hz									
		1: Frequency display unit 0.01%									
		2~38: RPM display, the set number represents the pole number of motor									
		40~9999: Users specify the format, Input 0XXXX represents the display of XXXX at 100%.									
		10001~19999: Users specify the format, Input 1XXXX represents the display of XXX.X at 100%.									
		20001~29999: Users specify the format, Input 2XXXX represents the display of XX.XX at 100%.									
		30001~39999: Users specify the format, Input 3XXXX represents the display of X.XXX at 100%.									

Group 16: LCD Function Parameters

Code	Parameter Name	Setting Range	Default	Unit	Control mode						Attribute
					V/F	V/F +PG	SLV	SV	PM SV	PM SLV	
16-04	Engineering Unit	0: without using engineering unit	0	-	0	0	0	0	0	-	
		1: FPM									
		2: CFM									
		3: PSI									
		4: GPH									
		5: GPM									
		6: IN									
		7: FT									
		8: /s									
		9: /m									
		10: /h									
		11: °F									
		12: inW									
		13: HP									
		14: m/s									
		15: MPM									
		16: CMM									
		17: W									
		18: KW									
		19: m									
		20: °C									
16-05	LCD Backlight	0~7	5	-	0	0	0	0	0	-	*1
16-06	Automatic Return Time	0~120	60	Sec	0	0	0	0	0	-	*1
16-07	Copy Function Selection	0: Do not copy parameters	0	-	0	0	0	0	0	-	
		1: Read inverter parameters and save to the operator.									
		2: Write the operator parameters to inverter.									
		3: Compare parameters of inverter and operator.									
16-08	Selection of Allowing Reading	0: Do not allow to read inverter parameters and save to the operator.	0	-	0	0	0	0	0	-	
		1: Allow to read inverter parameters and save to the operator.									
16-09	Selection of Operator Removed (LCD)	0: Keep operating when LCD operator is removed.	0	-	0	0	0	0	0	-	*1
		1: Display fault when LCD operator is removed									

Group 17: Automatic Tuning Parameters											
Code	Parameter Name	Setting Range	Default	Unit	Control mode						Attribute
					V/F	V/F +PG	SLV	SV	PM SV	PM SLV	
17-00	Mode Selection of Automatic Tuning	0: Rotation Auto-tune	0	-	O	O	O	O	X	-	
		1: Static Auto-tune									
		2: Stator Resistance Measurement									
		3: Reserved									
		4: Loop Test									
17-01	Motor Rated Output Power	0.00~600.00	-	KW	O	O	O	O	X	-	
17-02	Motor Rated Current	0.1~999.9	-	A	O	O	O	O	X	-	
17-03	Motor Rated Voltage	200V: 0.0~255.0	220	V	O	O	O	O	X	-	
		400V:0.0~510.0	440								
17-04	Motor Rated Frequency	10.0~400.0 10.0~1200.0 (when 00-31 = 1)	60.0	Hz	O	O	O	O	X	-	
17-05	Motor Rated Speed	0~24000	1750	rpm	O	O	O	O	X	-	
17-06	Pole Number of Motor	2,4,6,8,10,12,14,16	4	Pole	O	O	O	O	X	-	
17-07	Number of PG Pulse	0~60000	1024	ppr	X	O	X	O	X	-	
17-08	Motor no-load Voltage	200V: 50~240	-	V	O	O	O	O	X	-	
		400V:100~480									
17-09	Motor Excitation Current	15%~70% Motor Rated Current	-	A	O	O	O	O	X	-	
17-10	Automatic Tuning Start	0: Disable	0	-	O	O	O	O	X	-	
		1: Enable									
17-11	Error History of Automatic Tuning	0: No error	0	-	O	O	O	O	X	-	
		1: Motor data error									
		2: Stator resistance tuning error									
		3: Leakage induction tuning error									
		4: Rotor resistance tuning error									
		5: Mutual induction tuning error									
		6: Encoder error									
		7: DT Error									
		8: Motor's acceleration error									
9: Warning											
17-12 ~ 17-13	Reserved										

Group 18: Slip Compensation Parameters											
Code	Parameter Name	Setting Range	Default	Unit	Control mode						Attribute
					V/F	V/F +PG	SLV	SV	PM SV	PM SLV	
18-00	Slip Compensation Gain at Low Speed.	0.00~2.50	-	-	O	X	O	O	X	-	*1
18-01	Slip Compensation Gain at High Speed.	-1.00~1.00	0.0	-	O	X	O	X	X	-	*1
18-02	Slip Compensation Limit	0~250	200	%	O	X	X	X	X	-	
18-03	Slip Compensation Filter	0.0~10.0	1.0	Sec	O	X	X	X	X	-	
18-04	Regenerative Slip Compensation Selection	0: Disable	0	-	O	X	X	X	X	-	
		1: Enable									
18-05	FOC Delay Time	1~1000	100	ms	X	X	O	X	X	-	
18-06	FOC Gain	0.00~2.00	0.1	-	X	X	O	X	X	-	

Group 19: Wobble Frequency Parameters											
Code	Parameter Name	Setting Range	Default	Unit	Control mode						Attribute
					V/F	V/F +PG	SLV	SV	PM SV	PM SLV	
19-00	Center Frequency of Wobble Frequency	5.00~100.00	20.00	%	O	O	X	X	X	-	*1
19-01	Amplitude of Wobble Frequency	0.1~20.0	10.0	%	O	O	X	X	X	-	*1
19-02	Jump Frequency of Wobble Frequency	0.0~50.0	0.0	%	O	O	X	X	X	-	*1
19-03	Jump Time of Wobble Frequency	0~50	0	ms	O	O	X	X	X	-	*1
19-04	Wobble Frequency Cycle	0.0~1000.0	10.0	Sec	O	O	X	X	X	-	*1
19-05	Wobble Frequency Ratio	0.1~10.0	1.0		O	O	X	X	X	-	*1
19-06	Upper Offset Amplitude of Wobble Frequency	0.0~20.0	0.0	%	O	O	X	X	X	-	*1
19-07	Lower Offset Amplitude of Wobble Frequency	0.0~20.0	0.0	%	O	O	X	X	X	-	*1

Group 20: Speed Control Parameters											
Code	Parameter Name	Setting Range	Default	Unit	Control mode						Attribute
					V/F	V/F+PG	SLV	SV	PM SV	PM SLV	
20-00	ASR Gain 1	0.00~250.00	-	-	X	O	O	O	O	-	*1
20-01	ASR Integral Time 1	0.001~10.000	-	Sec	X	O	O	O	O	-	*1
20-02	ASR Gain 2	0.00~250.00	-	-	X	O	O	O	O	-	*1
20-03	ASR Integral Time 2	0.001~10.000	-	Sec	X	O	O	O	O	-	*1
20-04	ASR Integral Time Limit	0~300	200	%	X	X	O	O	O	-	
20-05	ASR Positive Limit	0.1 ~ 10.0	5.0	%	X	O	X	X	X	-	
20-06	ASR Negative Limit	0.1 ~ 10.0	1.0	%	X	O	X	X	X	-	
20-07	Selection of Acceleration and Deceleration of P/PI	0: PI speed control will be enabled only in constant speed. For the speed acceleration and deceleration, only use P control.	0	-	X	O	O	O	O	-	
		1: Speed control is enabled either in acceleration or deceleration.									
20-08	ASR Delay Time	0.000~0.500	0.001	Sec	X	X	O	O	O	-	
20-09	Speed Observer Proportional (P) Gain1	0.00~2.55	0.61	-	X	X	O	X	X	-	*1
20-10	Speed Observer Integral(I) Time 1	0.01~10.00	0.05	Sec	X	X	O	X	X	-	*1
20-11	Speed Observer Proportional (P) Gain2	0.00~2.55	0.61	-	X	X	O	X	X	-	*1
20-12	Speed Observer Integral(I) Time 2	0.01~10.00	0.06	Sec	X	X	O	X	X	-	*1
20-13	Low-pass Filter Time Constant of Speed Feedback 1	1~1000	4	ms	X	X	O	X	X	-	
20-14	Low-pass Filter Time Constant of Speed Feedback 2	1~1000	30	ms	X	X	O	X	X	-	
20-15	ASR Gain Change Frequency 1	0.0~400.0	4.0	Hz	X	O	O	X	X	-	
20-16	ASR Gain Change Frequency 2	0.0~400.0	8.0	Hz	X	X	O	X	X	-	
20-17	Torque Compensation Gain at Low Speed	0.00~2.50	1.00	-	X	X	O	X	X	-	*1
20-18	Torque Compensation Gain at High Speed	-10~10	0	%	X	X	O	X	X	-	*1
20-19	Over Speed (OS) Selection	0: Deceleration to stop	1		X	O	X	O	O	-	
		1: Coast to stop									
		2: Continue to operate									
20-20	Over Speed (OS) Detection Level	0~120	115	%	X	O	X	O	O	-	
20-21	Over Speed (OS) Detection Time	0.0~2.0	0.5	Sec	X	O	X	O	O	-	
20-22	Speed Deviation (DEV) Selection	0: Deceleration to Stop	2		X	O	X	O	O	-	
		1: Coast to Stop									
		2: Continue to Operate									

Group 20: Speed Control Parameters											
Code	Parameter Name	Setting Range	Default	Unit	Control mode						Attribute
					V/F	V/F+PG	SLV	SV	PM SV	PM SLV	
20-23	Speed Deviation (DEV) Detection Level	0~50	10	%	X	O	X	O	O	-	
20-24	Speed Deviation (DEV) Detection Time	0.0~10.0	0.5	Sec	X	O	X	O	O	-	
20-25	Selection of PG Open	0: Deceleration to Stop	1	-	X	O	X	O	O	-	
		1: Coast to Stop									
		2: Continue to Operate									
20-26	Detection Time of PG Open	0.0~10.0	2.0	Sec	X	O	X	O	O	-	
20-27	PG Pulse Number	0~60000	1024	ppr	X	O	X	O	O	-	
20-28	Selection of PG Rotation Direction	0: Forward as Counter -Clockwise Rotation	0	-	X	O	X	O	O	-	
		1: Forward as Clockwise Rotation									
20-29	PG Pulse Dividing Ratio	001~132	1	-	X	O	X	O	O	-	
20-30	PG Gear Ratio 1	1~1000	1	-	X	O	X	O	X	-	
20-31	PG Gear Ratio 2	1~1000	1	-	X	O	X	O	X	-	

Group 21: Torque And Position Control Parameters											
Code	Parameter Name	Setting Range	Default	Unit	Control mode						Attribute
					V/F	V/F+PG	SLV	SV	PM SV	PM SLV	
21-00	Torque Control Selection	0: Speed Control	0	-	X	X	X	O	O	-	
		1: Torque Control									
21-01	Filter Time of Torque Reference	0~1000	0	ms	X	X	X	O	O	-	
21-02	Speed Limit Selection	0: According to AI Input	0	-	X	X	X	O	O	-	
		1: According to the Set Value of 21-03									
21-03	Speed Limit Value	-120~120	0	%	X	X	X	O	O	-	
21-04	Speed Limit Bias	0~120	10	%	X	X	X	O	O	-	
21-05	Positive Torque Limit	0~300	200	%	X	X	O	O	O	-	
21-06	Negative Torque Limit	0~300	200	%	X	X	O	O	O	-	
21-07	Forward Regenerative Torque Limit	0~300	200	%	X	X	O	O	O	-	
21-08	Reversal Regenerative Torque Limit	0~300	200	%	X	X	O	O	O	-	
21-09	Maximum Frequency of Position Control	0.1~100.0	20.0	Hz	X	X	X	O	O	-	
21-10	The Command of Rotation Cycle Number of Section 0	-9999 ~ 9999	0	-	X	X	X	O	O	-	
21-11	The Command of the Pulse Number of Section 0	-9999 ~ 9999	0	-	X	X	X	O	O	-	
21-12	The Command of Rotation Cycle Number of Section 1	-9999 ~ 9999	0	-	X	X	X	O	O	-	

Group 21: Torque And Position Control Parameters

Code	Parameter Name	Setting Range	Default	Unit	Control mode						Attribute
					V/F	V/F +PG	SLV	SV	PM SV	PM SLV	
21-13	The Command of the Pulse Number of Section 1	-9999 ~ 9999	0	-	X	X	X	O	O	-	
21-14	The Command of Rotation Cycle Number of Section 2	-9999 ~ 9999	0	-	X	X	X	O	O	-	
21-15	The Command of the Pulse Number of Section 2	-9999 ~ 9999	0	-	X	X	X	O	O	-	
21-16	The Command of Rotation Cycle Number of Section 3	-9999 ~ 9999	0	-	X	X	X	O	O	-	
21-17	The Command of the Pulse Number of Section 3	-9999 ~ 9999	0	-	X	X	X	O	O	-	
21-18	The Command of Rotation Cycle Number of Section 4	-9999 ~ 9999	0	-	X	X	X	O	O	-	
21-19	The Command of the Pulse Number of Section 4	-9999 ~ 9999	0	-	X	X	X	O	O	-	
21-20	The Command of Rotation Cycle Number of Section 5	-9999 ~ 9999	0	-	X	X	X	O	O	-	
21-21	The Command of Rotation Cycle Number of Section 6	-9999 ~ 9999	0	-	X	X	X	O	O	-	
21-22	The Command of the Pulse Number of Section 6	-9999 ~ 9999	0	-	X	X	X	O	O	-	
21-23	The Command of Rotation Cycle Number of Section 7	-9999 ~ 9999	0	-	X	X	X	O	O	-	
21-24	The Command of the Pulse Number of Section 7	-9999 ~ 9999	0	-	X	X	X	O	O	-	
21-25	The Command of Rotation Cycle Number of Section 8	-9999 ~ 9999	0	-	X	X	X	O	O	-	
21-26	The Command of the Pulse Number of Section 8	-9999 ~ 9999	0	-	X	X	X	O	O	-	
21-27	The Command of Rotation Cycle Number of Section 9	-9999 ~ 9999	0	-	X	X	X	O	O	-	
21-28	The Command of the Pulse Number of Section 9	-9999 ~ 9999	0	-	X	X	X	O	O	-	
21-29	The Command of Rotation Cycle Number of Section 10	-9999 ~ 9999	0	-	X	X	X	O	O	-	

Group 21: Torque And Position Control Parameters

Code	Parameter Name	Setting Range	Default	Unit	Control mode						Attribute
					V/F	V/F +PG	SLV	SV	PM SV	PM SLV	
21-30	The Command of the Pulse Number of Section 10	-9999 ~ 9999	0	-	X	X	X	O	O	-	
21-31	The Command of Rotation Cycle Number of Section 11	-9999 ~ 9999	0	-	X	X	X	O	O	-	
21-32	The Command of the Pulse Number of Section 11	-9999 ~ 9999	0	-	X	X	X	O	O	-	
21-33	The Command of Rotation Cycle Number of Section 12	-9999 ~ 9999	0	-	X	X	X	O	O	-	
21-34	The Command of the Pulse Number of Section 12	-9999 ~ 9999	0	-	X	X	X	O	O	-	
21-35	The Command of Rotation Cycle Number of Section 13	-9999 ~ 9999	0	-	X	X	X	O	O	-	
21-36	The Command of the Pulse Number of Section 13	-9999 ~ 9999	0	-	X	X	X	O	O	-	
21-37	The Command of Rotation Cycle Number of Section 14	-9999 ~ 9999	0	-	X	X	X	O	O	-	
21-38	The Command of the Pulse Number of Section 14	-9999 ~ 9999	0	-	X	X	X	O	O	-	
21-39	The Command of Rotation Cycle Number of Section 15	-9999 ~ 9999	0	-	X	X	X	O	O	-	
21-40	The Command of the Pulse Number of Section 15	-9999 ~ 9999	0	-	X	X	X	O	O	-	
21-41	The Command of Rotation Cycle Number of Section 6	-9999 ~ 9999	0	-	X	X	X	O	O	-	
21-42	Pos. Mode Sel	0: Switch to position mode when output frequency < 01-08.	0		X	X	X	O	O	-	
21-43	Home Pos. Count	0 ~9999	0		X	X	X	O	O	-	

Group 22: PM Motor Parameters

Code	Parameter Name	Setting Range	Default	Unit	Control mode						Attribute
					V/F	V/F +PG	SLV	SV	PM SV	PM SLV	
22-00	PM Motor Rated Power	0.00~600.00	-	kW	X	X	X	X	O	-	
22-01	PM Motor Rated Voltage	200V: 50~240	220	V	X	X	X	X	O	-	
		400V: 100~480	440								
22-02	PM Motor Rated Current	0.1~999.9	-	A	X	X	X	X	O	-	
22-03	PM Motor 's Pole Number	2~96	6	poles	X	X	X	X	O	-	

Group 22: PM Motor Parameters

Code	Parameter Name	Setting Range	Default	Unit	Control mode						Attribute
					V/F	V/F+PG	SLV	SV	PM SV	PM SLV	
22-04	PM Motor's Rotation Speed	1~60000 (22-04, 22-06, only need to set one of them, the program will calculate the other.)	1500	rpm	X	X	X	X	O	-	
22-05	PM Motor's Maximum Rotation Speed	1~60000	1500	rpm	X	X	X	X	O	-	
22-06	PM Motor Frequency	0.1~400.0	75.0	Hz	X	X	X	X	O	-	
22-07 ~ 22-12	Reserved										
22-13	PM Encoder Type	0: TAMAGAWA Non Wire-Saving Encoder	0	-	X	X	X	X	O	-	
		1: TAMAGAWA Wire-Saving Encoder									
		2: SUMTAK Wire-Saving Encoder									
		3: General Incremental Encoder									
22-14 ~ 22-15	Reserved										
22-16	Offset Angle of the Magnetic Pole and PG Origin	0~360	0	deg	X	X	X	X	O	-	*4
22-17	PM Motor Tuning	0: None	0	-	X	X	X	X	O	-	
		1: Magnetic Pole Alignment and Loop Adjustment									
		2: Magnetic Pole Alignment									
22-18	Fault History of PM Motor Tuning	0. No Error	0	--	X	X	X	X	O	-	*4
		1. Static Magnetic Alignment Fault									
		2. Without PG Option Card									
		3. Rotation Pole Alignment is Forced to Stop									
		4. Rotation Pole Alignment is Time-out.									
		5. Loop Adjustment is Time out									
		6. Encoder Error									
		7. Other Errors of Motor Tuning									
		8. Current Abnormity Occurs when Aligning Rotation Magnetic Pole.									
		9. Current Abnormity Occurs while Loop Adjustment.									
10. Restart Magnetic Pole Alignment and Loop Adjustment											

4.4 Description of Parameters

00-00	Control mode selection
Range	0: V/F 1: V/F+PG 2: SLV 3: SV 4: PMSV 5: Reserved

The inverter offers the following control modes:

Value	Mode	Info	Application
0	V/F	V/F Control without PG	General Purpose Applications which do not require high precision speed control - Auto-tuning is not required.
1	V/F+PG	V/F Control with PG (speed compensation)	Closed loop speed control for General purpose applications that require better speed control than V/F mode without PG.
2	SLV	Sensorless Vector Control without PG	General Purpose Applications that require higher precision speed control and torque response without the use of an encoder.
3	SV	Closed Loop Vector Control with PG	General Purpose Applications that require high precision speed control and torque response with the use of an encoder.
4	PMSV	PM Vector Control with PG (Permanent Magnet Vector Control)	PM Motor Applications that require high precision speed control and torque response with the use of an encoder.
5	Reserved		

00-00=0: V/F Mode

Select the required V/F curve (01-00) based on your motor and application.

Perform a stationary auto-tune (17-00=2), if the motor cable is longer than 50m (165ft), see parameter 17-00 for details.

00-00=1: V/F with PG

Select the required V/F curve (01-00) based on your motor and application. Set number of motor poles (02-08) and encoder feedback pulses (20-27), refer to parameter group 20 for PF feedback setup. Perform a stationary auto-tune (17-00=2) if the distance between the inverter and the motor more than 50m (165ft), refer to parameter group 17 for details on auto-tuning.

00-00=2: Sensorless Vector Control

Verify the inverter rating matches the motor rating. Perform rotational auto-tune to measure and store motor parameters for higher performance operation. Perform non-rotational auto-tune if it's not possible to rotate the motor during auto-tune. Refer to parameter group 17 for details on auto-tuning.

00-00=3: Closed Loop Vector Control

Verify the inverter rating matches the motor rating. Perform rotational auto-tune to measure and store motor parameters for higher performance operation. Perform non-rotational auto-tune if it's not possible to rotate the motor during auto-tune. Refer to parameter group 17 for details on auto-tuning.

00-00=4: PM Vector Control

Verify the inverter rating matches the motor rating. Set PM motor data in parameters 22-00 to 22-06 and encoder feedback pulses in parameter 20-27. Refer to parameter 22-17 for details on PM Motor tuning.

Note: Parameter 00-00 is excluded from initialization.

00-01	Motor's rotation direction
Range	0: Forward 1: Reverse

Use the FWD/REV key to change motor direction when Run Command Selection (00-02 = 0) is set to keypad control.

00-02	Run command selection
Range	0: Keypad control 1: External terminal control 2: Communication control 3: PLC

00-02=0: Keypad Control

Use the keypad to start and stop the inverter and set direction with the forward / reverse key). Refer to section 4-1 for details on the keypad.

00-02=1: External terminal control

External terminals are used to start and stop the inverter and select motor direction.

The inverter can be operated in either 2-wire or 3-wire mode.

■ 2-wire operation

For 2-wire operation set 03-00 (S1 terminal selection) to 0 and 03-01 (S2 terminal selection) to 0.

Terminal S1	Terminal S2	Operation
Open	Open	Stop Inverter / FWD Active
Closed	Open	Run Forward
Open	Closed	Run Reverse
Closed	Closed	Stop Inverter, Display EF9 Alarm after 500ms

Parameter 13-08 to 2, 4 or 6 for 2-wire program initialization, multi-function input terminal S1 is set to forward , operation/ stop, and S2 is set for reverse, operation / stop.

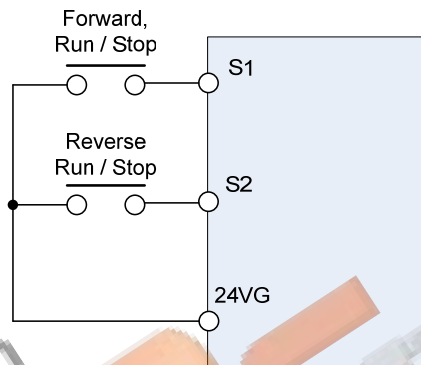

Figure 4.4.1 wiring example of 2-wire

■ 3-wire operation

For 3-wire operation set any of parameters 03-02 to 03-07 (terminal S3 ~ S8) to 26 to enable 3-wire operation in combination with S1 and S2 terminals set to run command and stop command.

Parameter 13-08 to 3, 5 or 7 for 3-wire program initialization, multi-function input terminal S1 is set to run operation, S2 for stop operation and S7 for forward/reverse command.

Note: Terminal S1 must be closed for a minimum of 50ms to activate operation.

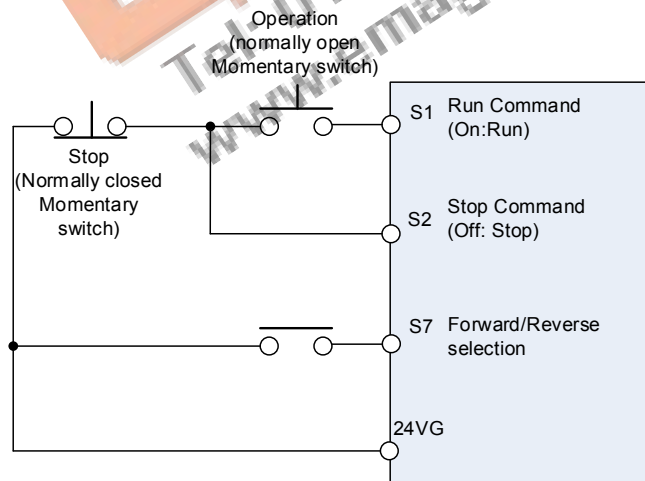

Figure 4.4.2 wiring example of 3-wire

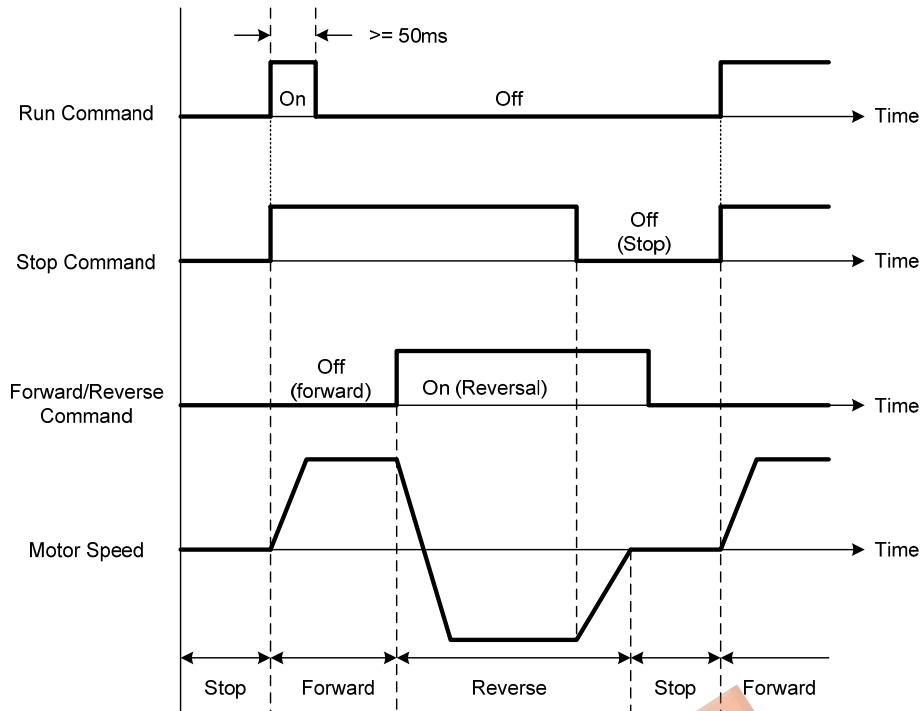
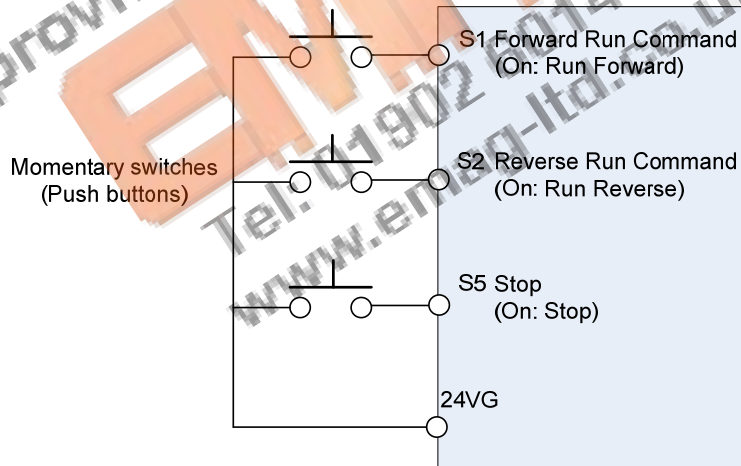

Figure 4.4.3 3-wire operation

■ 2-wire operation with hold function

To enable 2-wire operation with hold function set any of parameters 03-02 to 03-07 (terminal S3 ~ S8) to 53. When this mode is enabled set terminal S1 (03-00=0) to forward and S2 (03-01=1) to reverse run command.



Note: Terminal S1, S2 and S5 must be closed for a minimum of 50ms to activate operation.

Note: The inverter will display SE2 error when input terminals S1-S8 is set to 53 and 26 simultaneously.

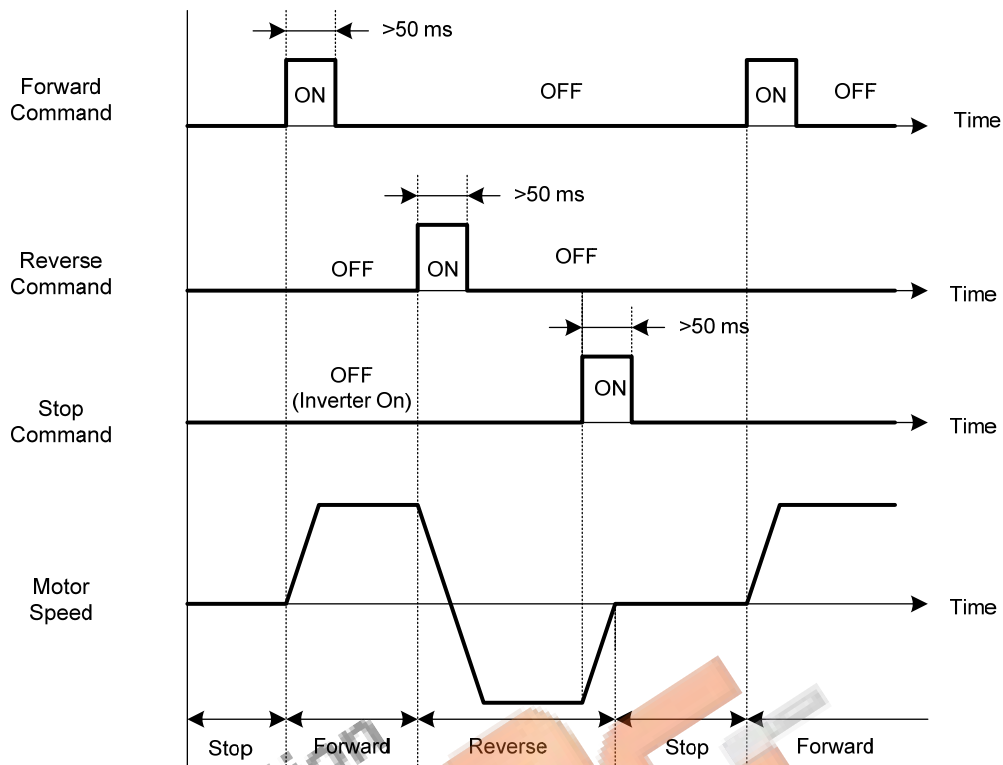

00-02=2: Communication control

The inverter is controlled by the RS-485 port. Refer to parameter group 9 for communication setup.

00-02=3: PLC control

The inverter is controlled by the inverter built-in PLC logic. Refer to section 4.5.

00-05	Main Frequency Command Source Selection
00-06	Alternative Frequency Source Selection
Range	<p>0: Keypad 1: External control (analog) 2: Terminal UP / DOWN 3: Communication control 4: Pulse input 5: PID</p>

00-05/00-06= 0: Keypad

Use the digital operator to enter frequency reference or to set parameter 05-01 (frequency reference 1) as alternative frequency reference source. Refer to section 4.1.4 for details.

00-05/00-06= 1: External control (Analog Input)

Use analog reference from analog input AI1 or AI2 to set the frequency reference (as shown in Figure 4.4.4). Refer to parameters 04-00 to select the signal type.

AI1 – Analog Input 1	AI2 – Analog Input 2	04-00 Setting (Default = 1)	Dipswitch SW2 (Default 'V')
0 ~ 10V	0 ~ 10V	0	Set to 'V'
0 ~ 10V	4 ~ 20mA	1	Set to 'I'
-10 ~ 10V	0 ~ 10V	2	Set to 'V'
-10 ~ 10V	4 ~ 20mA	3	Set to 'I'
0 ~ 12V	0 ~ 12V	4	Set to 'V'
0 ~ 12V	4 ~ 20mA	5	Set to 'I'
-12 ~ 12V	0 ~ 12V	6	Set to 'V'
-12 ~ 12V	4 ~ 20mA	7	Set to 'I'

Note: Set parameter 04-05 to 10 to add frequency reference using AI2 to AI1.

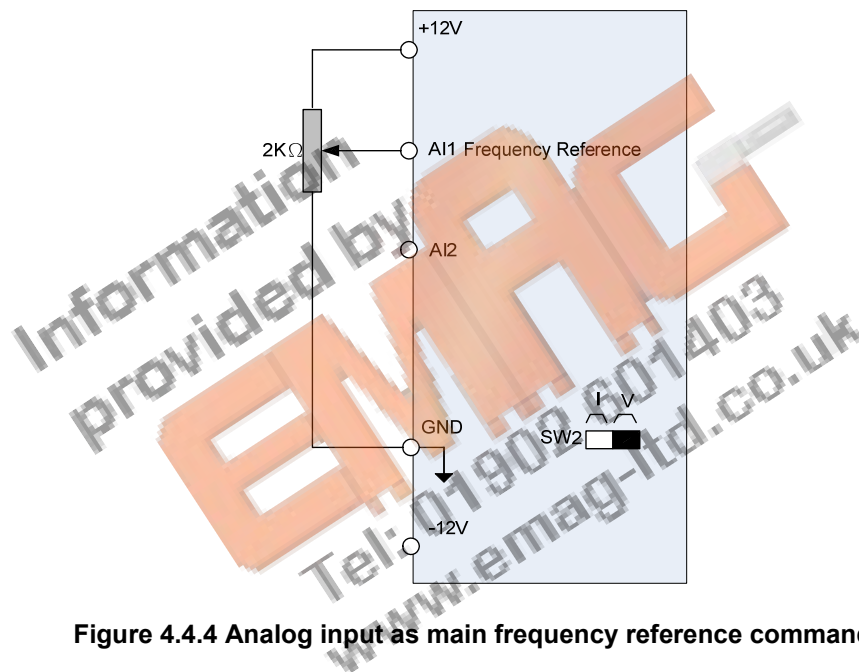

Figure 4.4.4 Analog input as main frequency reference command

00-05/00-06= 2: Terminal UP / DOWN

The inverter accelerates with the UP command closed and decelerates with the DOWN command closed. Please refer to parameter 03-00 ~ 03-07 for additional information.

Note: To use this function both the UP and DOWN command have to be selected to any of the input terminals.

00-05/00-06= 3: Communication control

The frequency reference command is set via the RS-485 communication port using the MODBUS RTU protocol.

Refer to parameter group 9 for additional information.

00-05/00-06= 4: Pulse input

To use this function a pulse train input is required to be connected to the PI input and GND (see fig. 4.4.5).

Set parameter 03-30 to 0 to use the pulse input as frequency reference. Refer to parameters 03-31 to 03-34 for pulse input scaling.

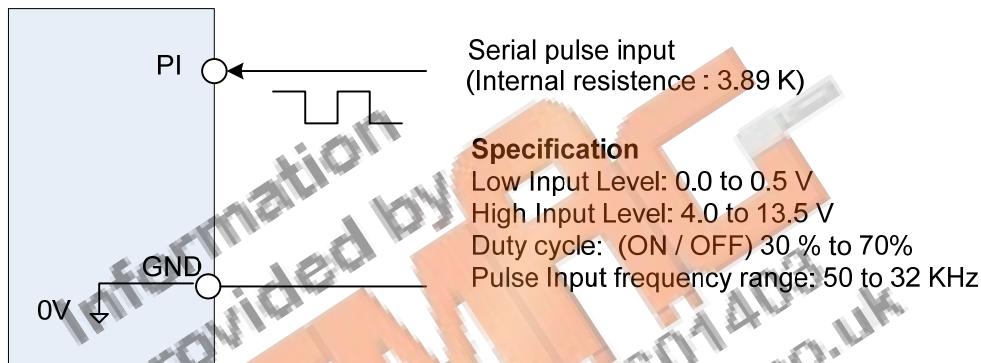

Figure 4.4.5 Frequency reference from pulse input

00-05/00-06= 5: PID

Enables PID control, reference frequency is controlled by the PID function. Refer to parameter group 10 for PID setup.

00- 07	Main and Alternative Frequency Command modes
Range	0: Main frequency 1: Main frequency + alternative frequency

When set to 0 the reference frequency is set by the main reference frequency selection of parameter 00-05.

When set to 1 the reference frequency is sum of the main reference frequency (00-05) and alternative frequency (00-06).

Note: The inverter will display the SE1 error when 00-07 = 1 and parameter 00-05 and 00-06 are set to the same selection.

When parameter 00-06 is set to 0 (Keypad) the alternative frequency reference is set by parameter 05-01 (Frequency setting of speed-stage 0).

00-08	Communication frequency command – READ ONLY
Range	0.00~400.00 Hz 0.0~1200.0 Hz (when 00-31 = 1)

Display the frequency reference when 00-05 or 00-06 is set to communication control (3).

00-09	Communication frequency command memory
Range	0: Don't save when power supply is off. (00-08) 1: Save when power is off. (00-08)

Note: This parameter is only enabled in communication mode.

00-12	Upper Frequency Limit
Range	0.1~109.0 %

Set the maximum frequency reference as a percentage of the maximum output frequency. Maximum output frequency depends on motor selection.

Motor 1: Maximum frequency parameter 01-02.

Motor 2: Maximum frequency parameter 01-16.

00-13	Lower Frequency Limit
Range	0.0~109.0 %

Set the minimum frequency reference as a percentage of the maximum output frequency. Maximum output frequency depends on motor selection. Motor 1: Maximum frequency is set by parameter 01-02 and Motor 2 Maximum frequency is set by parameter 01-16.

Notes:

- When the frequency lower limit is set to a value greater than 0 and the inverter is started the output frequency will accelerate to the frequency lower limit with a minimum frequency defined by parameter 01-08 for motor 1 and parameter 01-22 for motor 2.
- Frequency upper limit has to greater or equal to the frequency lower limit otherwise the inverter will display a SE01 (Set range error).
- Frequency upper and lower limit is active for all frequency reference modes.

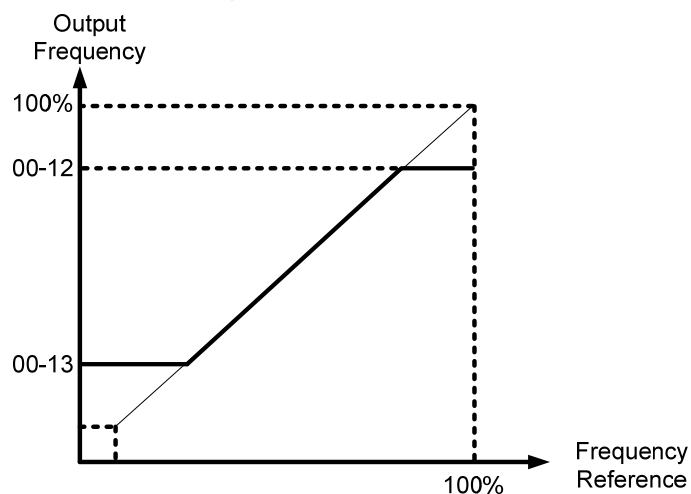

Figure 4.4.6 Frequency reference upper and lower limits

00-14	Acceleration time 1
Range	0.1~6000.0 Sec
00-15	Deceleration time 1
Range	0.1~6000.0 Sec
00-16	Acceleration time 2
Range	0.1~6000.0 Sec
00-17	Deceleration time 2
Range	0.1~6000.0 Sec
00-21	Acceleration time 3
Range	0.1~6000.0 Sec
00-22	Deceleration time 3
Range	0.1~6000.0 Sec
00-23	Acceleration time 4
Range	0.1~6000.0 Sec
00-24	Deceleration time 4
Range	0.1~6000.0 Sec
00-25	Switch-Over Frequency of Acceleration and Deceleration Time 1 and Time 4
Range	0.00~400.00 Hz 0.0~1200.0 Hz (When 00-31 = 1)

Acceleration time is the time required to accelerate from 0 to 100% of maximum output frequency.
Deceleration time is the time required to decelerate from 100 to 0% of maximum output frequency.
Motor 1: Maximum frequency is set by parameter 01-02 and Motor 2 Maximum frequency is set by parameter 01-16.

Note: Actual acceleration and deceleration times can be affected by the inverter driven load.

The default values for the acceleration, deceleration times are dependent on the inverter size.

Size		Acceleration / Deceleration Default Value
200V series	400V series	
1~10HP	1~15HP	10s
15~20HP	20~30HP	15s
30~150HP	40~425HP	20s

A: Select acceleration and deceleration time via the digital input terminals

The following table shows the acceleration / deceleration selected when the digital input function Accel/ Decel time 1 (#10) and Accel/Decel time 2 1(#30) are used.

Table 4.4.1 acceleration / deceleration time selection

Accel/decel time 2 (Set 03-00 ~ 03-07 = 30)	Accel/decel time 1 (Set 03-00 to 03-07 = 10)	Acceleration time	Deceleration time
0	0	Tacc1 (00-14)	Tdec1 (00-15)
0	1	Tacc2 (00-16)	Tdec2 (00-17)
1	0	Tacc3 (00-21)	Tdec3 (00-22)
1	1	Tacc4 (00-23)	Tdec4 (00-24)

0: OFF, 1: ON

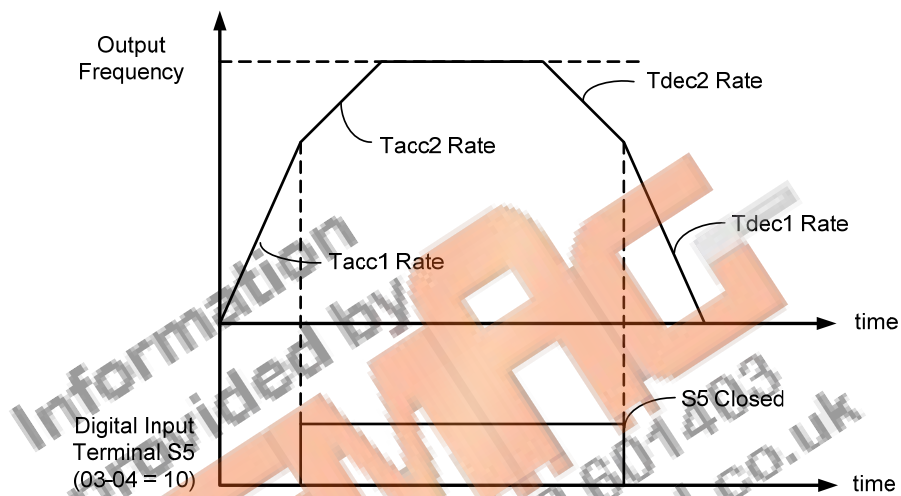

Figure 4.4.7: Terminal S5 switch between Tacc1/Tacc2 and Tdec1/Tdec2

B. Automatically acceleration / deceleration time switch-over based on output frequency

Set acceleration / deceleration switch over frequency parameter 00-25 to a value greater than 0 to automatically switch between Tacc1 (00-14) / Tdec1 (00-23) and Tacc4 (00-24) / Tdec4 (00-15).

Tacc1 (00-14) / Tdec1 (00-23) are active when the output frequency < 00-25 and Tacc4 (00-24) / Tdec4 (00-15) are active when the output frequency >= 00-25. Refer to the Figure 4.4.8. for details.

Note: Multi-function input function #10 (Accel/ Decel time 1) and #30 (Accel/ Decel time 2) have a higher priority than switch over frequency parameter 00-25.

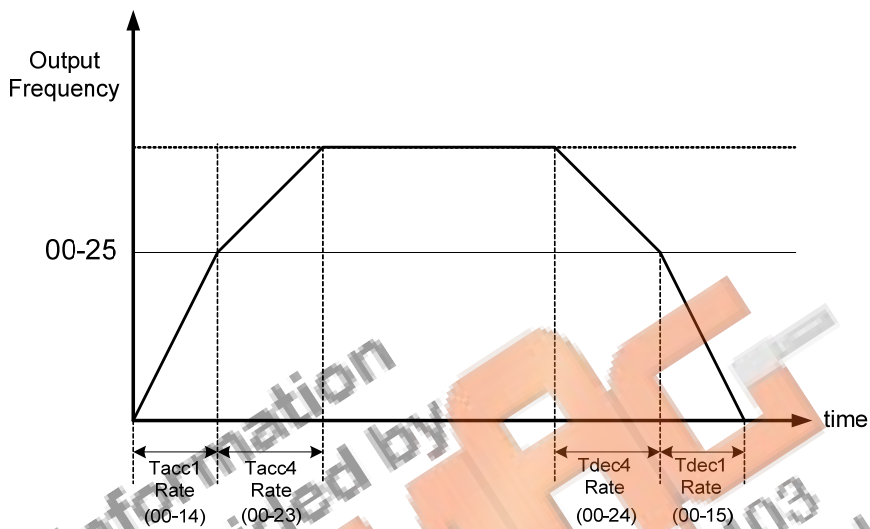

Figure 4.4.8 Automatic acceleration / deceleration time switch-over based on output frequency

00-18	Jog frequency
Range	0.00~400.00 Hz 0.0~1200.0 Hz (00-31 = 1)

00-19	Jog acceleration time
Range	0.1~6000.0 Sec

00-20	Jog deceleration time
Range	0.1~6000.0 Sec

Jog acceleration time (00-19) is the time required to accelerate from 0 to 100% of maximum output frequency. Jog deceleration time (00-20) is the time required to decelerate from 100 to 0% of maximum output frequency. Motor 1: Maximum frequency is set by parameter 01-02 and Motor 2 Maximum frequency is set by parameter 01-16.

The inverter uses the Jog frequency (00-18, default 6.0 Hz) as its frequency reference when jog is active.

00-26	Emergency stop time
Range	0.0~6000.0 Sec

The emergency stop time is used in combination with multi-function digital input function #14 (Emergency stop). When emergency stop input is activated the inverter will decelerate to a stop using the Emergency stop time (00-26) and display the [EM STOP] condition on the keypad.

Note: To cancel the emergency stop condition the run command has to be removed and emergency stop input deactivated.

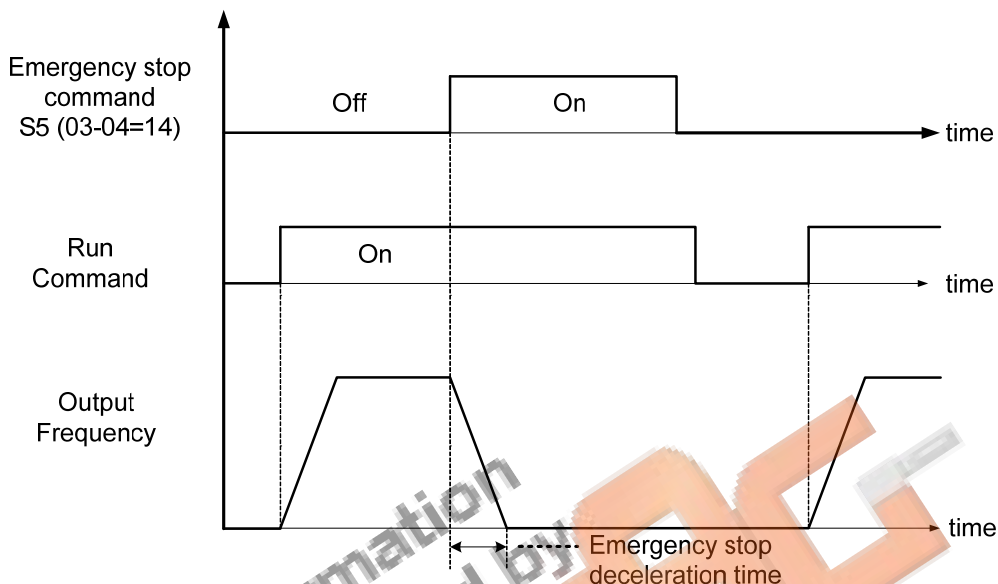

Figure 4.4.9 Emergency stop example

Multi-function digital input terminals (03-00 ~ 03-07) are set to 14: When the emergency stop input is activated the inverter will decelerate to a stop using the time set in parameter 00-26.

Note: After an emergency stop command the run command and emergency stop command have to be removed before the inverter can be restarted. Please refer to Figure 4.4.9. The emergency stop function can be used to stop inverter in case of an external event.

Multi-function digital input terminals (03-00 ~ 03-07) set to 15: When the base block input is activated the inverter output will turn off and the motor will coast to a stop.

00-27	HD/ND selection
Range	0: HD (Heavy Duty / Constant Torque) 1: ND (Normal Duty / Variable Torque)

The inverter overload curve, carrier frequency, stalls prevention level, rated input/output current and maximum frequency are automatically set based on the inverter duty (HD/ND) selection.

Please refer to table 4.4.2 for detailed information.

Table 4.4.2 Heavy Duty (Constant torque) / Normal Duty (Variable torque)

00-27	Overload capacity	Carrier frequency	Maximum output frequency	Stall prevention level	Rated input / output current
0 (Heavy Duty)	150%, 1min	2-16KHz (KVA dependent)	400.00Hz	150% (08-00, 08-01)	Refer to section 3.7
1 (Normal Duty)	120%, 1min	2-16KHz (KVA dependent)	120.00Hz	120% (08-00, 08-01)	

00-27= 0: Heavy Duty Mode

Select V/F curve (Group 1) and enter motor data (Group 2) to match the application. In Heavy Duty mode the maximum output frequency is 400 Hz for all control modes, except for SLV mode (Sensorless Vector / Open Loop Vector Mode) where the maximum output frequency is limited based on the inverter rating, see table below.

Horsepower	Maximum output frequency
200V 1~25HP, 400V 1~30HP	150Hz
200V 30HP and above, 400V 40HP and above	100Hz

00-27= 1: Normal Duty Mode

In normal duty mode only applies to control modes V/F and V/F + PG. All other modes use the Heavy Duty settings.

00-28	Command characteristic selection of master frequency
Range	0: Positive characteristic (0-10V / 4-20mA = 0 - 100%) 1: Negative / inverse characteristic (0-10V / 4~20mA = 100 - 0%)

00-28= 0: Positive reference curve, 0 – 10V / 4 – 20mA = 0 – 100% main frequency reference.

00-28= 1: Negative reference curve, 0 – 10V / 4 – 20mA = 100 – 0% main frequency reference.

Note: Selection applies to analog input AI1 and AI2.

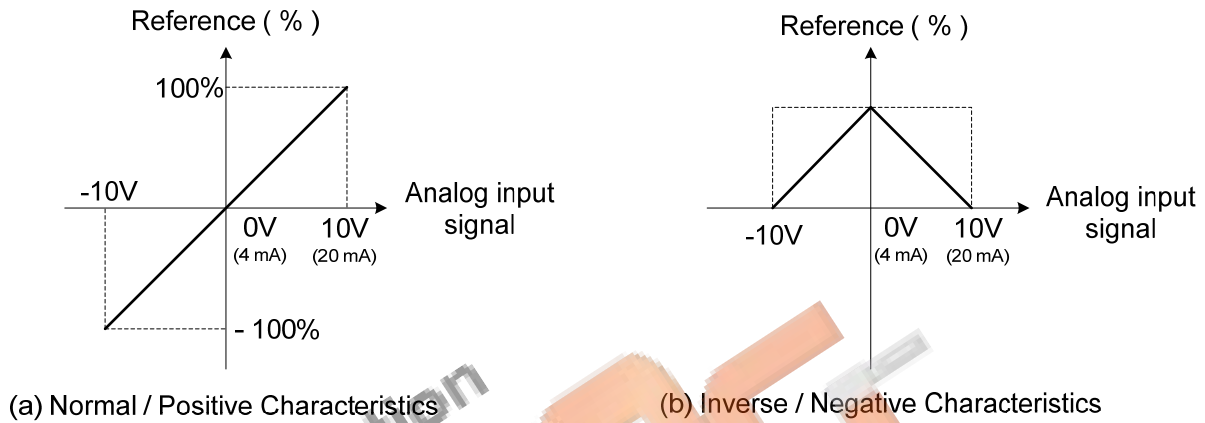

Figure 4.4.10 Positive/negative analog input as main frequency reference command.

00-29	Zero-speed operation selection
Range	0: Operation based on frequency command 1: Stop 2: Operation based on lowest frequency 3: Zero-speed operation

Refer to figure 4.4.11 for zero-speed operation in sensor vector mode (SV / PMSV) (00-00=3 or 00-00=4).

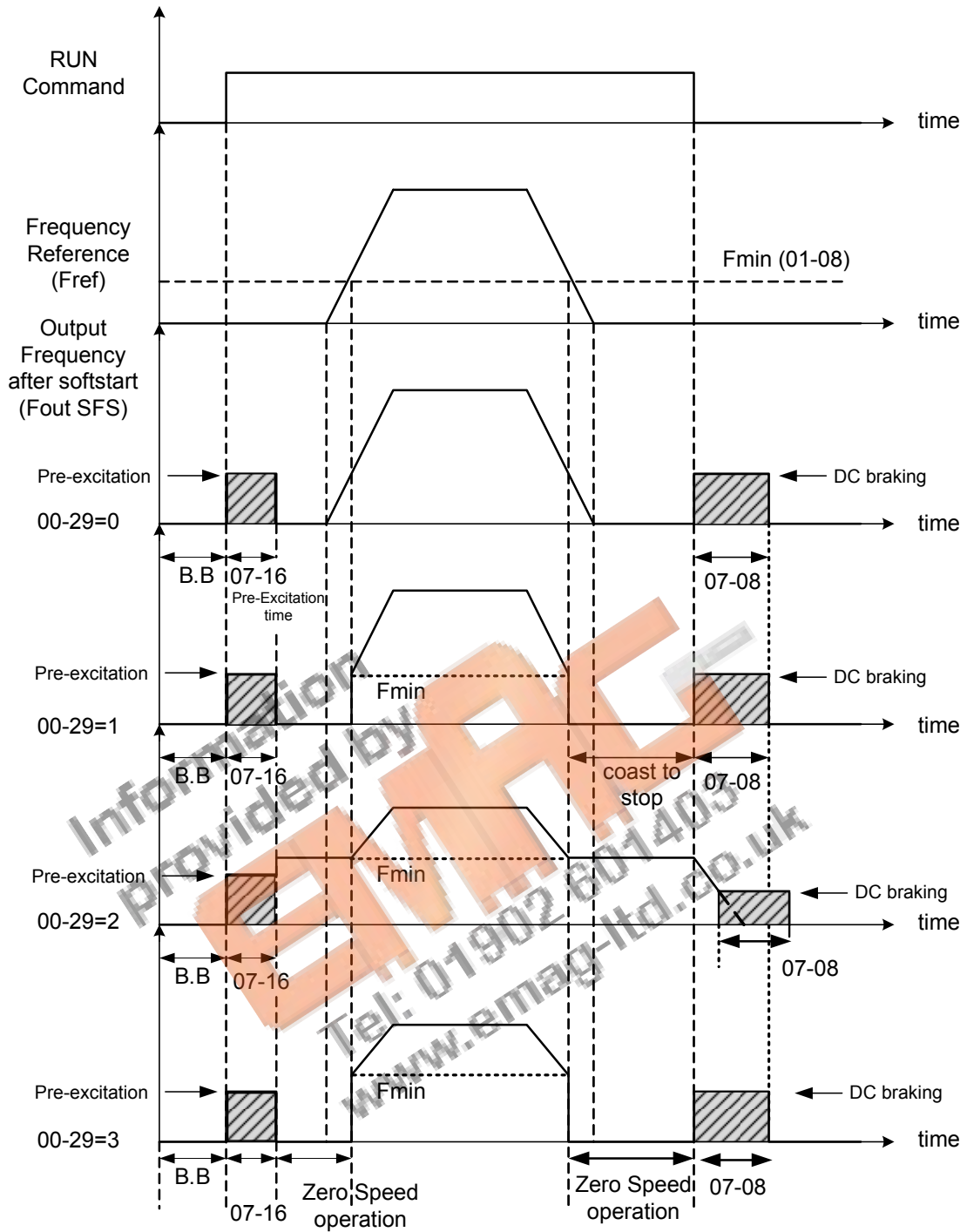

Figure 4.4.11 Zero-speed operation of sensor vector (SV) and PM vector (PMSV) mode

DC injection braking activates when the run command is removed and output frequency falls below the DC injection braking start frequency (07-06). DC injection braking will be active for the time set in parameter 07-08 DC injection braking execution time. Refer to figure 4.4.62 for more information on the pre-excitation operation.

00-31	Maximum frequency
Range	0: 400.00Hz 1: 1200.0Hz

00-31=0: Set maximum frequency to 400.00 Hz

00-31=1: Set maximum frequency to 1200.00 Hz

Note: Frequency reference on the keypad (00-05=0 / 00-06=0) is limited to the maximum frequency for motor 1 (01-02) or maximum frequency for motor 1 (01-31) setting. Actual maximum output frequency depends on duty cycle selection (00-27) and control mode (00-00).

00-32	Application
Range	0: Disabled 1: Water supply pump 2: Conveyor 3: Exhaust fan 4: HVAC 5: Compressor 6: Hoist- * Consult TECO for the settings 7: Crane- * Consult TECO for the settings

Application selection allows users to setup the inverter for dedicated applications. This function automatically sets a predefined group of parameters as well as input and outputs to the appropriate value for the selected application.

00-32=1: Water supply pump

Parameter	Name	Value
00-00	Control mode selection	0: V/F
11-00	Direction lock selection	1: Forward direction only
00-14	Acceleration time 1	1.0 sec
00-15	Deceleration time 1	1.0 sec
00-27	HD/ND selection	1: ND
01-00	V/F curve selection	F
01-04	Middle output frequency 2 of motor 1	30.0 Hz
01-05	Middle output voltage 2 of motor 1	60.0 V
07-00	Momentary stop and restart selection	1: Enable
08-00	Stall prevention function	xx0xb: Stall prevention during deceleration

00-32=2: Conveyor

Parameter	Name	Value
00-00	Control mode selection	0: V/F
00-14	Acceleration time 1	3.0 sec
00-15	Deceleration time 1	3.0 sec
00-27	HD/ND selection	0: HD
08-00	Stall prevention function	xx0xb: Stall prevention during deceleration

00-32=3: Exhaust fan

Parameter	Name	Value
00-00	Control mode selection	0: V/F
11-00	Direction lock selection	1: Forward direction only
00-27	HD/ND selection	1: ND
01-00	V/F curve selection	F
01-04	Middle output frequency 2 of motor 1	30.0 Hz
01-05	Middle output voltage 2 of motor 1	50.0 V
07-00	Momentary stop and restart selection	1: Enable
08-00	Stall prevention function	xx0xb: Stall prevention during deceleration

00-32=4: HVAC

Parameter	Name	Value
00-00	Control mode selection	0 : V/F
11-00	Direction lock selection	1: Forward direction only
00-27	HD/ND selection	1: ND
11-01	Carrier frequency	8.0kHz
07-00	Momentary stop and restart selection	1: Enable
11-03	Automatic carrier frequency reduction	1: Enable

00-32=5: Compressor

Parameter	Name	Value
00-00	Control mode selection	0: V/F
11-00	Direction lock selection	1: Forward direction only
00-14	Acceleration time 1	5.0 sec
00-15	Deceleration time 1	5.0 sec
00-27	HD/ND selection	0: HD
01-00	V/F curve selection	F
07-00	Momentary stop and restart selection	1: Enable
08-00	Stall prevention function	xx0xb: Stall prevention during deceleration

00-32=6: Hoist* Consult TECO for the detailed settings

Parameter	Name	Value
00-00	Control mode selection	2: SLV
00-05	Main Frequency command source selection	0: keypad
11-43	Hold Frequency at start	3.0 Hz
11-44	Frequency hold Time at start	0.3 sec
00-14	Acceleration time 1	3.0 sec
00-15	Deceleration time 1	3.0 sec
00-27	HD/ND selection	0 : HD
11-01	Carrier frequency	5.0kHz
05-01	Frequency setting of speed-stage 0	6.0 Hz
06-01	Frequency setting of speed-stage 1	30.0 Hz
06-02	Frequency setting of speed-stage 2	60.0 Hz
01-00	V/F curve selection	F
03-28	Photo-coupler output	5 : frequency detection 2
07-18	Minimum baseblock time	0.3 sec
08-00	Stall prevention function	xx1x: Stall prevention ineffective in deceleration
03-13	Frequency detection level	2.0 Hz
03-14	Frequency detection width	0.0 Hz
08-18	Selection of low-torque operation	0: Deceleration to stop
08-19	Level of low-torque detection	2 %
08-20	Time of low-torque detection	0.5 sec
08-09	Selection of input phase loss protection	1 : Enable
08-10	Selection of output phase loss protection	1 : Enable
11-03	Selection of reducing carrier automatically	1: Enable

00-32=7: Crane* Consult TECO for the detailed settings

Parameter	Name	Value
00-00	Control mode selection	0: V/F
00-05	Main Frequency Command Source Selection	0: keypad
00-14	Acceleration time 1	3.0 sec
00-15	Deceleration time 1	3.0 sec
00-27	HD/ND Mode selection	0: HD
11-01	Carrier frequency	5.0kHz
05-01	Frequency setting of speed-stage 0	6.0 Hz
06-01	Frequency setting of speed-stage 1	30.0 Hz
06-02	Frequency setting of speed-stage 2	60.0 Hz
03-04	Multi-function terminal Function setting-S5	2: Multi-speed/position setting command 1
03-05	Multi-function terminal Function setting-S6	3: Multi-speed/position setting command 2
03-28	Photo-coupler output	23: Source of operation command
08-00	Stall prevention function	xx1x : Stall prevention ineffective in deceleration
08-09	Selection of input phase loss protection	1: Enable
08-10	Selection of output phase loss protection	1: Enable

Information provided by
EMAG
 Tel: 01902 601403
 www.emag-ltd.co.uk

01-V/F Control Parameters	
----------------------------------	--

01-00	V/F curve selection
Range	0~FF

The V/F curve selection is enabled for V/F mode with or without PG. Make sure to set the inverter input voltage parameter 01-14.

There are three ways to set V/F curve:

- (1) 01-00 = 0 to E: choose any of the 15 predefined curves (0 to E).
- (2) 01-00 = 0F, use 01-02~01-09 and 01-12~01-13, with voltage limit.
- (3) 01-00 = FF: use 01-02~01-09 and 01-12~01-13, without voltage limit.

The default parameters (01-02~01-09) are the same when 01-00 is set to F (default) and 01-00 is set to 1.

Parameters 01-02 to 01-13 are automatically set when any of the predefined V/F curves are selected.

This parameter is not affected by the initialization parameter (13-08).

Consider the following items as the conditions for selecting a V/F pattern.

- (1) The voltage and frequency characteristic of motor.
- (2) The maximum speed of motor.

Information
provided by
EMAG
Tel: 01902 601403
www.emag-ltd.co.uk

Table 4.4.3: 1 - 2HP V/F curve selection

Type	Specification	01-00	V/F curve *1	Type	Specification	01-00	V/F curve *1		
General purpose	50Hz	0		High Starting Torque ‡	50Hz	Low Starting Torque	8		
			High Starting Torque			9			
	60 Hz	60Hz Saturation	1 F (Def. Val.)			60Hz	Low Starting Torque	A	
		50Hz Saturation	2			High Starting Torque	B		
Variable Torque Characteristic	72Hz	3		Constant power torque (Reducer)	90Hz	C			
								50 Hz	Variable Torque 1
	Variable Torque 2	5							
	60 Hz	Variable Torque 3	6			180Hz	E		
		Variable Torque 4	7						

*1. Values shown are for 200V class inverters; double values for 400V class inverters.

‡Select high starting torque only for the following conditions.

- (1) The power cable length is > 150m (492ft).
- (2) Voltage drop at startup is high.
- (3) An AC reactor is used on the input side or output side of the inverter.
- (4) Motor power lower than the inverter rated power.

Type	Specification	01-00 setting	V/F curve*1
High speed motor	1200Hz	F (00-31 = 1)	<p>The graph shows a V/F curve for a high-speed motor. The vertical axis represents Voltage (V) with values 0, 7.8, 57.5, and 200. The horizontal axis represents Frequency (Hz) with values 0, 200, 400, 800, and 1200. The curve starts at the origin (0,0), rises linearly through points (200, 7.8) and (400, 57.5), reaches a peak of 200V at 800Hz, and then remains constant at 200V up to 1200Hz.</p>

*1. Values shown are for 200V class inverters; double values for 400V class inverters.

Information
provided by
EMAG
Tel: 01902 601403
www.emag-ltd.co.uk

Table 4.4.4: 3 - 30HP V/F curve selection

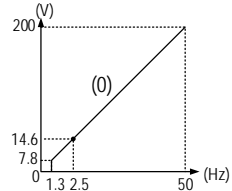
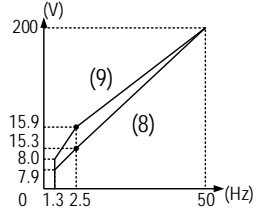
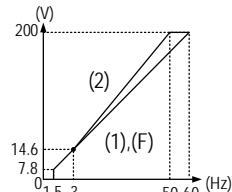
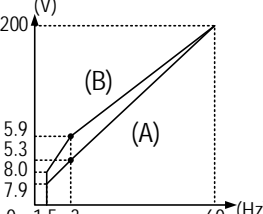
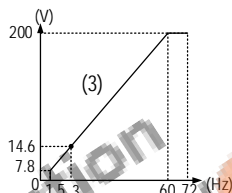
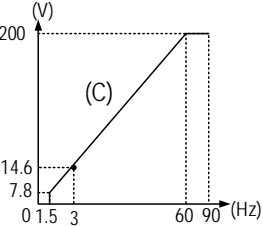
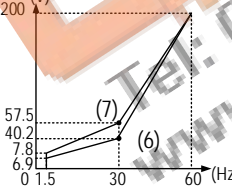
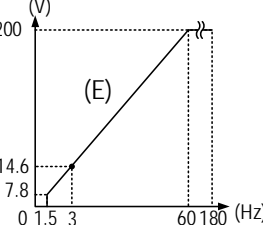
Type	Specification	01-00	V/F curve*1	Type	Specification	01-00	V/F curve*1		
General application	50Hz	0		High Starting Torque†	50Hz	Low Starting Torque	8		
			High Starting Torque			9			
	60Hz	60Hz Saturation	1			60Hz	Low Starting Torque	A	
		50Hz Saturation	2				High Starting Torque	B	
Variable Torque Characteristic	72Hz	3		Constant-power torque (Reducer)	90Hz	C			
								50Hz	Variable Torque 1
	Variable Torque 2	5							
	60Hz	Variable Torque 3	6			180Hz	E		
		Variable Torque 4	7						

*1. Values shown are for 200V class inverters; double value for 400V class inverters.

†Select high starting torque only for the following conditions.

- (1) The power cable length is > 150m (492ft).
- (2) Voltage drop at startup is high.
- (3) An AC reactor is used on the input side or output side of the inverter.
- (4) Motor power lower than the inverter rated power.

Type	Specification	01-00 setting	V/F curve*1
High speed motor	1200Hz	F (Set 00-31 to 1)	<p>The graph shows a V/F curve for a high-speed motor. The vertical axis represents Voltage (V) with markings at 0, 7.8, 57.5, and 200. The horizontal axis represents Frequency (Hz) with markings at 0, 200, 400, 800, and 1200. The curve starts at the origin (0,0), rises linearly through points (200, 7.8), (400, 57.5), and (800, 200). From 800 Hz to 1200 Hz, the voltage remains constant at 200 V.</p>

*1. Values shown are for 200V class inverters; double values for 400V class inverters.

Information
provided by
EMAG
Tel: 01902 601403
www.emag-ltd.co.uk

Table 4.4.5 40HP and above V/F curve selection

Type	Specification	01-00	V/F curve*1	Type	Specification	01-00	V/F curve*1		
General application	50Hz	0		High Starting Torque†	50Hz	Low Starting Torque			
			High Starting Torque			9			
	60Hz	60Hz Saturation	1 F (Def. Val.)			60Hz	Low Starting Torque	A	
		50Hz Saturation	2			High Starting Torque	B		
Descending torque (Mechanics of wind, water and other force)	72Hz	3		Constant-power torque (Reducer)	90Hz	C			
			50Hz			Variable Torque 1	4		120Hz
	Variable Torque 2	5			180Hz	E			
	60Hz	Variable Torque 3	6				180Hz	E	
		Variable Torque 4	7						

*1. Values shown are for 200V class inverters; double values for 400V class inverters.

*2. High-speed motor (operation frequency > 400Hz) is not supported above 40HP.

†Select high starting torque only for the following conditions.

- (1) The power cable length is > 150m (492ft).
- (2) Voltage drop at startup is high.
- (3) An AC reactor is used on the input side or output side of the inverter.
- (4) Motor power lower than the inverter rated power.

01-02	Maximum output frequency of motor 1
Range	20.0~400.0 Hz 20.0~1200.0 Hz (00-31 = 1)
01-03	Maximum output voltage of motor 1
Range	200V: 0.1~255.0 V 400V: 0.2~510.0 V
01-04	Middle output frequency 2 of motor 1
Range	0.0~400.0 Hz 0.0~1200.0 Hz (00-31 = 1)
01-05	Middle output voltage 2 of motor 1
Range	200V: 0.0~255.0 V 400V: 0.0~510.0 V
01-06	Middle output frequency 1 of motor 1
Range	0.0~400.0 Hz 0.0~1200.0 Hz (00-31 = 1)
01-07	Middle output voltage 1 of motor 1
Range	200V: 0.0~255.0 V 400V: 0.0~510.0 V
01-08	Minimum output frequency of motor 1
Range	0.0~400.0 Hz 0.0~1200.0 Hz (00-31 = 1)
01-09	Minimum output voltage of the motor 1
Range	200V: 0.0~255.0 V 400V: 0.0~510.0 V
01-12	Base frequency of motor 1
Range	10.0~400.0 Hz 10.0~1200.0 Hz (00-31 = 1)
01-13	Base output voltage of motor 1
Range	200V: 0.0~255.0 V 400V: 0.0~510.0 V

V/F curve setting (01-02~01-09 and 01-12~01-13)

Select any of the predefined V/F curves setting '0' to 'E' that best matches your application and the load characteristic of your motor, choose a custom curve setting 'F' or 'FF' to set a custom curve.

Important:

Improper V/F curve selection can result in low motor torque or increased current due to excitation.

For low torque or high speed applications, the motor may overheat. Make sure to provide adequate cooling when operating the motor under these conditions for a longer period of time.

If the automatic torque boost function is enabled (parameter 01-10), the applied motor voltage will automatically change to provide adequate motor torque during start or operating at low frequency.

Custom V/F Curve Setting:

A custom curve selection allows users to set parameters 01-02 ~ 01-13 whereas a predefined curve selection does not.

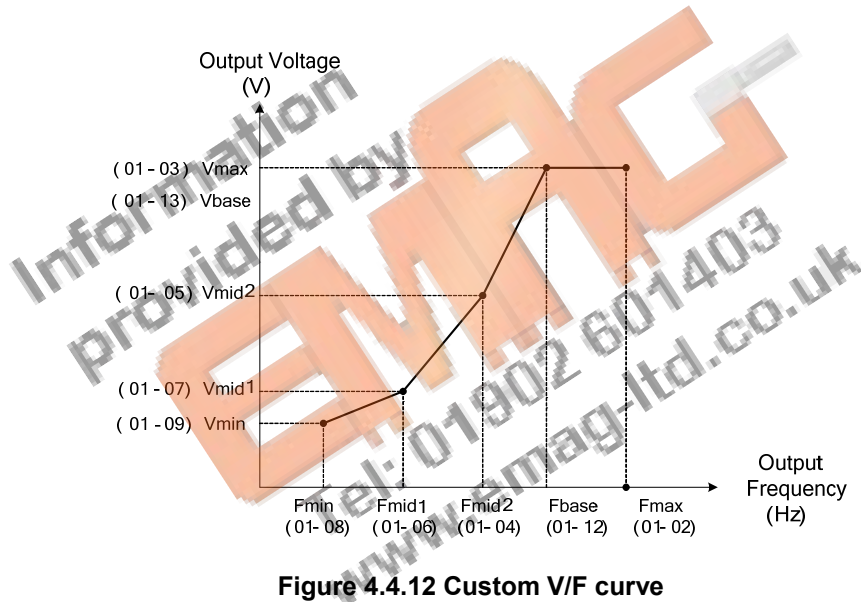

Figure 4.4.12 Custom V/F curve

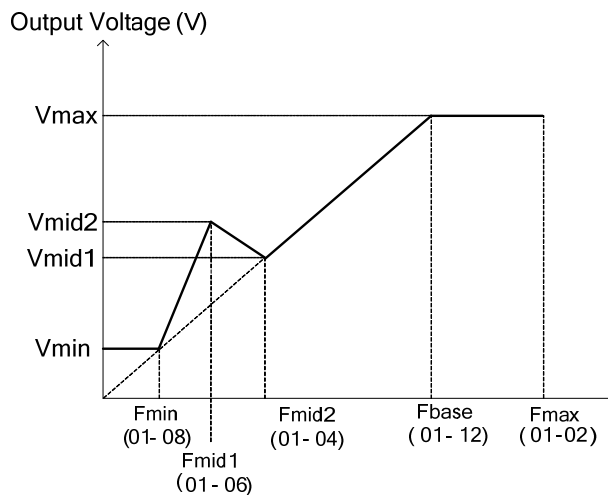

Figure 4.4.13 Torque boosting

When setting the frequency related parameters for a custom V/F curve values make sure that:

$$\begin{matrix} F_{\max} & > & F_{\text{base}} & > & F_{\text{mid2}} & > & F_{\text{mid1}} & > & F_{\min} \\ (01-02) & & (01-12) & & (01-04) & & (01-06) & & (01-08) \end{matrix}$$

The 'SE03' V/F curve tuning error is displayed when the frequency values are set incorrectly.

When 01-04 and 01-05 (or 01-18 and 01-09) are set to 0, the inverter ignores the set values of Fmin2 and Vmin2.

When the control mode is changed parameter 00-00, 01-08 (F_{\min}) and 01-09 (V_{\min}) will automatically be changed to the default setting of the selected control mode.

SLV or SV Mode (Sensorless Vector or Sensor Vector Control)

Enter the motor data in parameter group 17 for SV and SLV control mode (00-00) and perform auto-tuning.

In the SV and SLV mode the V/F curve normally does not have to be re-adjusted after a successful auto-tune.

The maximum output frequency setting 01-02 (F_{\max}), base frequency 01-12 (F_{base}), minimum output frequency 01-08 (F_{\min}), maximum output voltage 01-03 (V_{\max}) or base output voltage 01-13 (V_{base}) can be adjusted but the voltage is automatically adjusted by the internal current controller.

Set the base frequency (01-12, F_{base}) to the motor rated frequency on the motor nameplate.

Perform the auto-tuning procedure after adjusting parameters 02-19 or 17-04 to reduce the voltage at no-load operation.

Motor jitter can be reduced by lowering the no-load voltage. Please note that lowering the no-load voltage increases the current at no-load.

Information provided by
EMAG
Tel: 01902 601403
www.emag-ltd.co.uk

01-10	Torque compensation gain
Range	0.0~2.0

In V/F or V/F + PG mode the inverter automatically adjusts the output voltage to adjust the output torque during start or during load changes based on the calculated loss of motor voltage.

The rate of adjustment can be changed with the Torque compensation gain parameter.

Refer to the torque compensation gain adjustment shown in Figure 4.4.14.

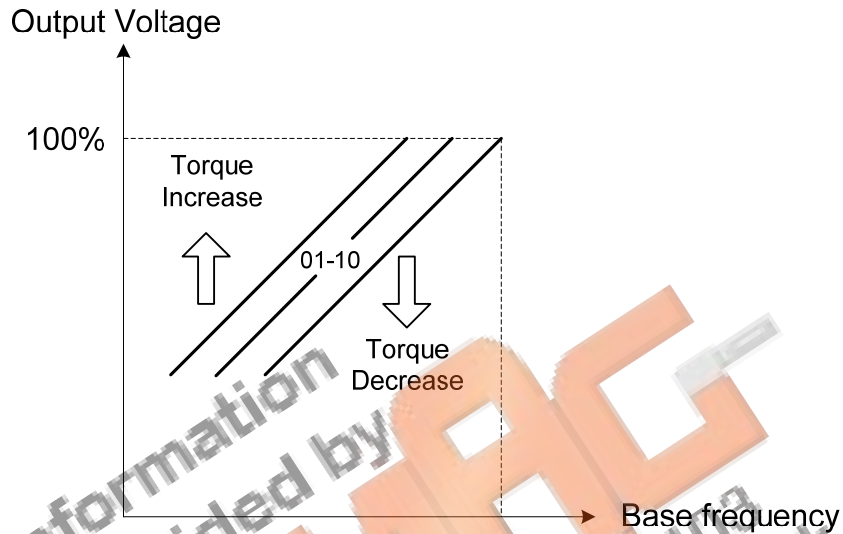

Figure 4.4.14 Torque compensation gain to increase/decrease output torque

Increase value when:

- The wiring between the inverter and the motor very too long
- The motor size is smaller than the inverter size

Note: Gradually increase the torque compensation value and make sure the output current does not exceed inverter rated current.

Reduce value when:

- When experiencing motor vibration

Important:

Confirm that the output current at low speed does not exceed the rated output current of the inverter.

01-14	Input voltage setting
Range	200V: 155.0~255.0 V 400V: 310.0~510.0 V

Set the inverter input voltage (E.g. 200V / 208V / 230V / 240V or 380V / 415V / 440V / 460V / 480V).

This parameter is used as a reference for predefined V/F curve calculation (01-00 = 0 to E), over-voltage protection level, stall prevention, etc...

01-15	Torque compensation time
Range	1~1000 ms

Set the torque compensation delay time in milliseconds.

Only adjust in the following situations:

Increase value when:

- When experiencing motor vibration

Decrease value when:

- When motor torque response is too slow

Information
provided by
EMAG
Tel: 01902 601403
www.emag-ltd.co.uk

01- 16	Maximum output frequency of motor 2
Range	20.0~400.0 Hz 20.0~1200.0 Hz (when 00-31 = 1)
01- 17	Maximum output voltage of motor 2
Range	200V:0.1~255.0 V 400V:0.2~510.0 V
01- 18	Middle output frequency 2 of motor 2
Range	0.0~400.0 Hz 0.0~1200.0 Hz (when 00-31 = 1)
01- 19	Middle output voltage 2 of motor 2
Range	200V: 0.0~255.0 V 400V: 0.0~510.0 V
01- 20	Middle output frequency 1 of motor 2
Range	0.0~400.0 Hz 0.0~1200.0 Hz (when 00-31 = 1)
01- 21	Middle output voltage 1 of motor 2
Range	200V: 0.0~255.0 V 400V: 0.0~510.0 V
01- 22	Minimum output frequency of motor 2
Range	0.0~400.0 Hz 0.0~1200.0 Hz (when 00-31 = 1)
01-23	Minimum output voltage of motor 2
Range	200V: 0.0~255.0 V 400V: 0.0~510.0 V
01- 24	Base frequency of motor 2
Range	10.0~400.0 Hz 10.0~1200.0 Hz (when 00-31 = 1)
01- 25	Base voltage of motor 2
Range	200V: 0.0~255.0 V 400V: 0.0~510.0 V

Note: Motor 2 V/F curve uses the same settings as motor 1.

02 - IM Motor Parameters

02-00	No-load current of motor 1
Range	0.01~600.00 A
02-01	Rated current of motor 1
Range	V/F and V/F+PG modes are 10%~200% of inverter's rated current. SLV, SV modes are 25%~200% of inverter's rated current.
02-03	Rated rotation speed of motor1
Range	0~60000 rpm
02-04	Rated voltage of motor1
Range	200V: 50.0~240.0 V 400V: 100.0~480.0 V
02-05	Rated power of motor 1
Range	0.01~600.00 KW
02-06	Rated frequency of motor 1
Range	10.0~400.0 Hz+ 10.0~1200.0 Hz (when 00-31 = 1)
02-07	Pole of motor 1
Range	2,4,6,8,10,12,14,16
02-09	Excitation current of motor 1
Range	10.0~100.0 %
02-10	Core saturation coefficient 1 of motor 1
Range	0~100 %
02-11	Core saturation coefficient 2 of motor 1
Range	0~100 %
02-12	Core saturation coefficient 3 of motor 1
Range	80~300 %
02-13	Core loss of motor 1
Range	0.0~15.0 %
02-15	Resistance between wires of motor 1
Range	0.001~60.000 Ω
02-16	Rotor resistance of motor 1
Range	0.001~60.000 Ω

02-17	Leakage inductance of motor 1
Range	0.01~200.00 mH
02-18	Mutual inductance of motor 1
Range	0.1~6553.5 mH
02-19	No-Load Voltage of motor 1
Range	200V: 50~240 V 400V: 100~480 V

Motor parameters are automatically set when performing an auto-tune (17-10=1). In most case no adjustment is required after performing an auto-tune except when using the inverter in special applications (e.g. machine tool, positioning, etc...).

Please refer to parameter group 22 for permanent magnet motor parameters.

(1) Number of motor poles (02-07)

Set the number of motor pole according to the motor nameplate.

(2) Motor rated power (02-05)

Set the motor power according to the motor nameplate.

(3) Motor rated current (02-01)

Set the motor rated current according to the motor nameplate.

(4) Motor rated voltage (02-04)

Set the motor rated voltage according to the motor nameplate.

(5) Rated frequency of motor 1 (02-06)

Set the motor rated frequency according to the motor nameplate.

(6) Rated rotation speed of motor 1 (02-03)

Set the motor rpm according to the motor nameplate.

(7) No-load motor voltage (02-19)

Parameter determines the rated flux during motor's rated rotation in SLV or SV control mode. Set the value of this parameter to the same value as parameter 17-08. A value of 10~50V below the input voltage level ensures that the motor is capable of providing adequate torque performance when operating at nominal speed (or higher speed). Setting the value to small can result in a reduction in no-load current, weakened motor flux and an increase in motor current while the motor is loaded.

(8) Motor excitation current (02-09)

This parameter is automatically set during auto-tune. No adjustment required.

(9) Setting of motor core's saturation coefficient 1, 2 and 3 (02-10, 02-11, 02-12)

These parameters are automatically set during auto-tune. No adjustment required. Parameters are set to 50% for 02-10, 75% for 02-11 and 137.5% for 02-12 to reduce the impact of core saturation. The motor core's saturation coefficient is defined as a percentage of the motor excitation current. When the motor flux reaches 137.5% level, the core's saturation coefficient shall be greater than 137.5%. When the motor flux is 50% or 75%, the core's saturation coefficient is required to be less than 50% and 75%.

(10) Motor core loss (02-13)

Set motor core loss as the percentage of the motor rated power.

$$\% W_{\text{core}} (02-13) = \frac{3 \times \text{Motor core loss (watt)}}{\text{Motor rated power (watts, 02-05)}} \times 100\%$$

Note: In V/F mode motor core loss (02-13) is used to for torque compensation.

(11) Motor line to line resistance (02-15)

(12) Motor rotor resistance R2 (02-16)

(13) Motor leakage inductance (02-17)

(14) Motor mutual inductance (02-18)

(15) Motor no-load current (02-00).

Value is calculated based on the motor rated frequency (17-05) and motor rated current (17-03).

In V / F control mode, the output current is greater than the no-load current with slip compensation is enabled.

Note: The value of 02-01 needs to be greater than the value set in parameter 02-00, otherwise warning message "SE01" out of range error will be displayed.



Figure 4.4.15 Y-equivalent model an induction motor

02-20	No-Load Current of motor 2
Range	0.01~600.00 A

02-21	Rated current of motor 2
Range	10%~200% of inverter's rated current

02-22	Rated rotation speed of motor 2
Range	0~ 60000 rpm
02- 23	Rated voltage of motor 2
Range	200V: 50.0~240.0 V 400V: 100.0~480.0 V
02- 24	Rated power of motor 2
Range	0.01~600.00 kW
02-25	Rated frequency of motor 2
Range	10.0~400.0 Hz 10.0~1200.0 Hz (00-31 = 1)
02-26	Pole of motor 2
Range	2,4,6,8,10,12,14,16
02-32	Resistance between wires of motor 2
Range	0.001~60.000 Ω

Note: Motor 2 V/F curve uses the same settings as motor 1. The control mode setting for motor 2 is fixed to V/F.

Information
provided by
EMAG
Tel: 01902 601403
www.emag-ltd.co.uk

03- External Digital Input and Output Parameters

03-00	Multi-function terminal function setting – S1
03-01	Multi-function terminal function setting – S2
03-02	Multi-function terminal function setting – S3
03-03	Multi-function terminal function setting – S4
03-04	Multi-function terminal function setting – S5
03-05	Multi-function terminal function setting – S6
03-06	Multi-function terminal function setting – S7
03-07	Multi-function terminal function setting – S8
Range	<p> 0: 2-Wire sequence (ON: Forward run command) 1: 2-Wire sequence (ON: Reverse run command) 2: Multi-speed/position setting command 1 3: Multi-speed/position setting command 2 4: Multi-speed/position setting command 3 5: Multi-speed/position setting command 4 6: Forward jog run command 7: Reverse jog run command 8: UP frequency increasing command 9: DOWN frequency decreasing command 10: Acceleration/deceleration setting command 1 11: Inhibit Acceleration/deceleration Command 12~13: Reserved 14: Emergency stop (decelerate to zero and stop) 15: External Baseblock Command(rotation freely to stop) 16: PID control disable 17: Fault reset (RESET) 18: Reserved 19: Speed Search 1 (from the maximum frequency) 20: Manual energy saving function 21: PID integral reset 22~23: Reserved 24: PLC input 25: External fault 26: 3-Wire sequence (Forward/Reverse command) 27: Local/Remote selection 28: Remote mode selection 29: Jog frequency selection 30: Acceleration/deceleration setting command 2 31: Inverter overheating warning 32: Sync command 33: DC braking 34: Speed Search 2 (from the frequency command) 35: Time function input 36: PID Soft start disabled 37: Traversing operation 38: Upper Deviation of traverse operation 39: Lower Deviation of traverse operation 40: Switching between motor 1/motor 2 41: Reserved </p>

<p>42: PG disable</p> <p>43: PG integral reset</p> <p>44: Mode switching between speed and torque</p> <p>45: Negative torque command</p> <p>46: Zero-Servo Command</p> <p>47: Fire Mode</p> <p>48: KEB acceleration</p> <p>49: Parameter writing allowable</p> <p>50: Unattended Start Protection (USP)</p> <p>51: Mode switching between speed and position</p> <p>52: Multi - Position enable</p> <p>53: 2-Wire Stop</p>
--

Refer to the multi-function digital input and related parameters in the following figure 4.4.16.

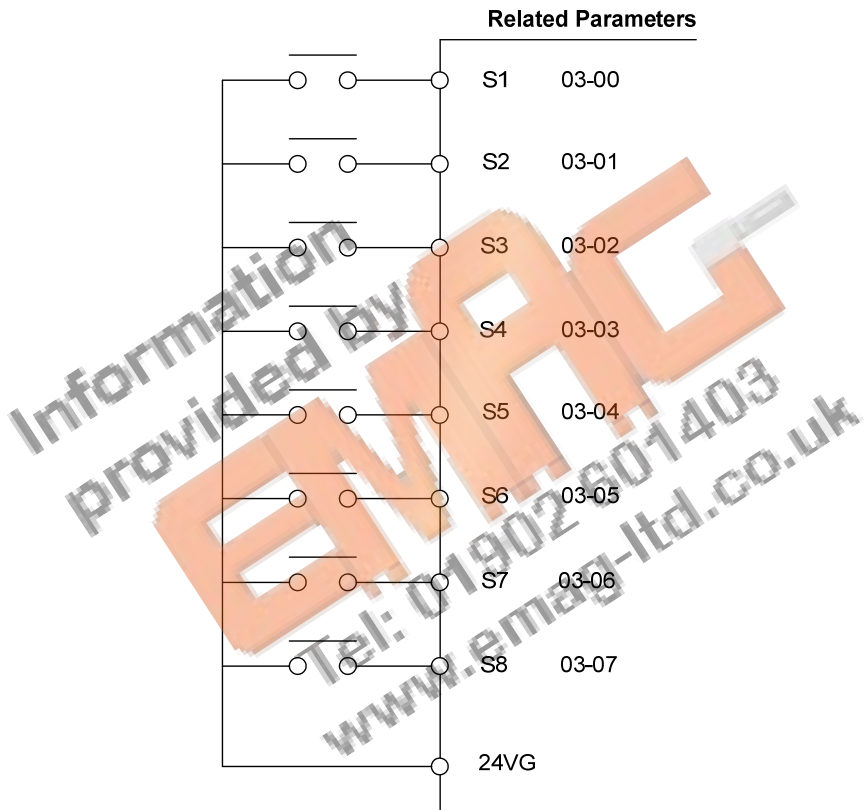

Figure 4.4.16 Multi-function digital input and related parameters

Table 4.4.6 Multi-function digital input setting (03-00 to 03-07) (“O”: Enable, “X”: Disable)

Value	Function		Description	Control mode				
	Name	LCD Display		V/F	V/F + PG	SLV	SV	PM SV
0	2-wire type (Forward operation)	2-Wire (FWD-RUN)	2- wire (ON : Forward operation command).	0	0	0	0	0
1	2-wire type (Reverse operation)	2-Wire (REV-RUN)	2- wire (ON : Reverse operation command).	0	0	0	0	0
2	Multi-speed/position setting command 1	Muti-Spd/Pos Ref 1	Multi-Speed Reference /Position Reference 1	0	0	0	0	0
3	Multi-speed/position setting command 2	Muti-Spd/Pos Ref 2	Multi-Speed Reference /Position Reference 2	0	0	0	0	0
4	Multi-speed/position setting command 3	Muti-Spd/Pos Ref 3	Multi-speed Reference /Position Reference 3	0	0	0	0	0
5	Multi-speed/position setting command 4	Muti-Spd/Pos Ref 4	Multi-speed Reference /Position Reference 4	0	0	0	0	0
6	Forward jog run command	FJOG	ON: Forward operation in jog mode (00-18).	0	0	0	0	0
7	Reverse jog run command	RJOG	ON: Reverse operation in jog mode (00-18).	0	0	0	0	0
8	UP frequency increasing command	UP command	ON: Command of output frequency increasing (only used by support of DOWN command).	0	0	0	0	0
9	DOWN frequency decreasing command	DOWN command	ON: Command of output frequency decreasing (only used by support of UP command).	0	0	0	0	0
10	Acceleration/deceleration time selection 1	Acc/Decel Time Selection 1	Acceleration/deceleration time selection command1	0	0	0	0	0
11	Inhibit Acceleration/deceleration Command	ACC/DEC Inhibit	ON: Acceleration/ deceleration prohibition	0	0	0	0	0
12~13	Reserved	Reserved	Reserved	-	-	-	-	-
14	Emergency stop (decelerate to zero and stop)	E-Stop	ON: Emergency stop input	0	0	0	0	0
15	External baseblock command (rotation freely to stop)	Ext. BB	ON: Inverter base interdiction	0	0	0	0	0
16	PID control disabled	PID Disable	ON: PID control disabled	0	0	0	0	0
17	Fault reset	Fault Reset	Fault reset	0	0	0	0	0
18	Reserved	Reserved	Reserved	-	-	-	-	-
19	Speed Search 1 (from the maximum frequency)	Speed Search 1	ON: Search the speed from the maximum output frequency	0	X	0	X	0
20	Manual energy saving function	Energy saving	ON: Manual energy saving control is based on the settings of 11-12 and 11-18.	0	0	X	X	0
21	PID integral reset	PID I-Reset	ON: PID integral value reset	0	0	0	0	0
22~23	Reserved	Reserved	Reserved	-	-	-	-	-
24	PLC input	PLC Input	ON: Digital PLC input	0	0	0	0	0
25	External fault	Ext. Fault	ON: External fault alarm	0	0	0	0	0

Value	Function		Description	Control mode				
	Name	LCD Display		V/F	V/F + PG	SLV	SV	PM SV
26	3-Wire sequence (Forward/Reverse command)	3-Wire (FWD/REV)	3-wire control (forward/reverse command). When the parameter is set to 26, terminal S1 and terminal will become operation command and stop command respectively, and their original functions will be closed.	0	0	0	0	0
27	Local/Remote selection	Local/Remote	ON: Local mode (via the digital operator) OFF: Frequency command and operation command will be determined according to the setting of parameter (00-02 and 00-05).	0	0	0	0	0
28	Remote mode selection	Remote Mode Sel	ON: RS-485 communication OFF: Control circuit terminal	0	0	0	0	0
29	Jog frequency command	JOG Freq Ref	ON: selection jog frequency command	0	0	0	0	0
30	Acceleration/deceleration setting command 2	Acc/Decel Time Selection 2	Acceleration/deceleration time selection command2	0	0	0	0	0
31	Inverter overheating warning	Overheat Alarm	ON: Inverter overheat alarm (OH2) input(will display OH2)	0	0	0	0	0
32	Sync command	Sync Command	ON: Synchronous speed start OFF: Synchronous speed close (Start other frequency command).	0	0	0	0	0
33	DC braking	DC Brake Command	ON: Perform DC braking	0	0	0	0	0
34	Speed Search 2 (from the frequency command)	Speed Search 2	ON: Search speed from set frequency	0	X	0	X	0
35	Time function input	Time Input	.Set the time function at 03-33, 03-34 .Set the time function output at 03-11, 03-12	0	0	0	0	0
36	PID Soft start ineffective	PID SFS Disable	ON: PID slow-start off	0	0	0	0	0
37	Traversing operation	Wobble Run	ON: Frequency wobbling operation	0	0	X	X	0
38	Upper Deviation of traverse operation	Upper Dev Run	ON: Upper offset off frequency wobbling	0	0	X	X	0
39	Lower Deviation of traverse operation	Lower Dev Run	ON: Lower offset off frequency wobbling	0	0	X	X	0
40	Switching between motor 1/motor 2	Motor 2 Switch	ON: Start motor 2	0	0	0	0	0
41	Reserved	Reserved	Reserved	-	-	-	-	-
42	PG disabled	PG disabled	ON: Speed control without PG	X	0	X	X	0
43	PG integral reset	I-Time Reset	ON: Integral value reset of speed control with PG	X	0	X	0	0
44	Mode switching between speed and torque	Speed/Torque change	ON: Torque control mode	X	X	X	0	0
45	Negative torque command	Reverse Tref	ON: Reverse external torque command	X	X	X	0	0

Value	Function		Description	Control mode				
	Name	LCD Display		V/F	V/F + PG	SLV	SV	PM SV
46	Zero-servo command	Zero-Servo	ON: Zero-servo operation	X	X	X	O	O
47	Fire Mode	Fire Mode	ON: Turn off hardware and software fault or alarm protection (a special application of HVAC)	O	O	O	O	O
48	KEB acceleration	KEB Accel.	ON: KEB acceleration start	O	O	O	O	O
49	Parameters writing allowable	Write Enabled	ON: all parameters are writable OFF: Except reference frequency (00-05) all parameters are write-protected.	O	O	O	O	O
50	Unattended Start Protection (USP)	USP	ON: After power is input, the inverter ignores the operation command OFF: After power is input, the inverter will return the operation status before power is cut off.	O	O	O	O	O
51	Mode switching between speed and position	Multi Pos. Switch	ON: Switch to position mode OFF: Switch to speed mode	X	X	X	O	O

03-0X =00: 2-wire control: forward operation

03-0X =01: 2-wire control: reverse operation. Refer to the 2-wire operation mode in Figure 4.4.1.

03-0X =02: Multi-speed/position setting command 1.

03-0X =03: Multi-speed/position setting command 2.

03-0X =04: Multi-speed/position setting command 3.

03-0X =05: Multi-speed/position setting command 4 (setting =05).

Select frequency reference using multi-function digital input.

In SV or PMSV mode (00-00=3, 4), with 03-00~07 set to 51, multi-speed command can be used to select multiple segment positions.

03-0X =29: Jog frequency selection (setting =29). Select frequency reference using the multi-function digital input.

In SV or PMSV mode (00-00=3, 4), with 03-00~07 set to 51, multi-speed command can be used to select multiple segment positions.

Table 4.4.7 Multi-speed operation selection

Speed	Multi-function digital input (S1 to S8) *3					Frequency selection
	Jog frequency reference	Multi-speed frequency 4	Multi-speed frequency 3	Multi-speed frequency 2	Multi-speed frequency 1	
1	0	0	0	0	0	Frequency command 1 (05-01) or main speed frequency *2
2	0	0	0	0	1	Auxiliary speed frequency or frequency reference 2 (06-01)
3	0	0	0	1	0	Frequency command 3 (06-02)
4	0	0	0	1	1	Frequency command 4 (06-03)
5	0	0	1	0	0	Frequency command 5 (06-04)
6	0	0	1	0	1	Frequency command 6 (06-05)
7	0	0	1	1	0	Frequency command 7 (06-06)
8	0	0	1	1	1	Frequency command 8 (06-07)
9	0	1	0	0	0	Frequency command 9 (06-08)
10	0	1	0	0	1	Frequency command 10 (06-09)
11	0	1	0	1	0	Frequency command 11(06-10)
12	0	1	0	1	1	Frequency command 12 (06-11)
13	0	1	1	0	0	Frequency command 13 (06-12)
14	0	1	1	0	1	Frequency command 14(06-13)
15	0	1	1	1	0	Frequency command 15 (06-14)
16	0	1	1	1	1	Frequency command 16 (06-15)
17	1 *1	—	—	—	—	Jog frequency command (00-18)

0: OFF, 1: ON, -: Ignore

*1. Jog frequency terminal has a higher priority than multi-speed reference 1 to 4.

*2. When parameter 00-05=0 (frequency reference input = digital operator), multi-speed frequency 1 will be set by 05-01 frequency reference setting1). When parameter 00-05=1 (frequency reference input=control circuit terminal), multi-speed frequency command 1 is input through analog command terminal A11 or A12).

*3. Multi-speed operation is disabled when PID is enabled.

Wiring Example: Figure 4.4.17 and 4.4.18 show an example of a 9-speed operation selection.

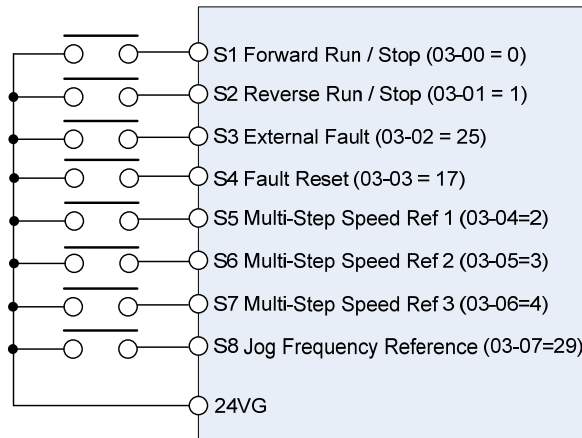

Figure 4.4.17 Control Terminal Wiring Example

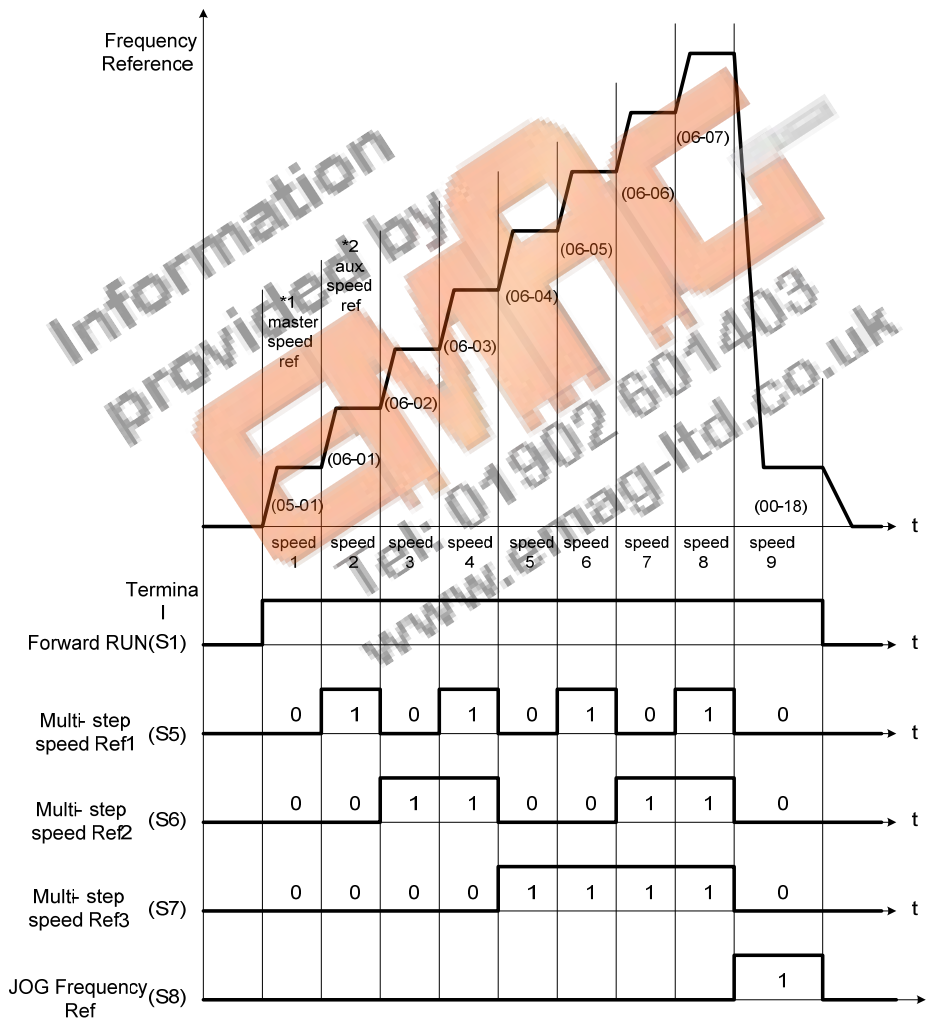

Figure 4.4.18: 9-speed timing diagram

*1. When 00-05=1, multi-speed frequency reference is set by analog input AI1 or AI2.

03-0X =06: Forward jog run command, uses jog frequency parameter 00-18.

Note:

- Jog command has a higher priority than other frequency reference commands.
- Jog command uses stop mode set in parameter 07-09 when Jog command is active > 500ms.

03-0X =07: Reverse jog run command, uses jog frequency parameter 00-18.

Note:

- Jog command has a higher priority than other frequency reference commands.
- Jog command uses stop mode set in parameter 07-09 when Jog command is active > 500ms.

03-0X =08: UP frequency command; set parameter 00-05 Frequency command to 2 to activate. Refer to parameter 11-56 for UP/DOWN mode.

03-0X =09: Down frequency command; set parameter 00-05 Frequency command to 2 to activate. Refer to parameter 11-56 for UP/DOWN mode.

Note: UP/DOWN frequency command follows standard acceleration and deceleration times Tacc1 / Tdec1 (00-14, 00-15) or Tacc2 / Tdec 2 (00-16, 00-17) and requires both UP and DOWN functions 08 and 09 to be programmed to the digital input terminals.

Note: SE02 DI terminal Error will be displayed when:

- When only the UP or DOWN command function is programmed to the digital inputs.
- When both UP and DOWN command are activated simultaneously.

For the examples of UP/DOWN control wiring and operation, please refer to figure 4.4.19 and 4.4.20.

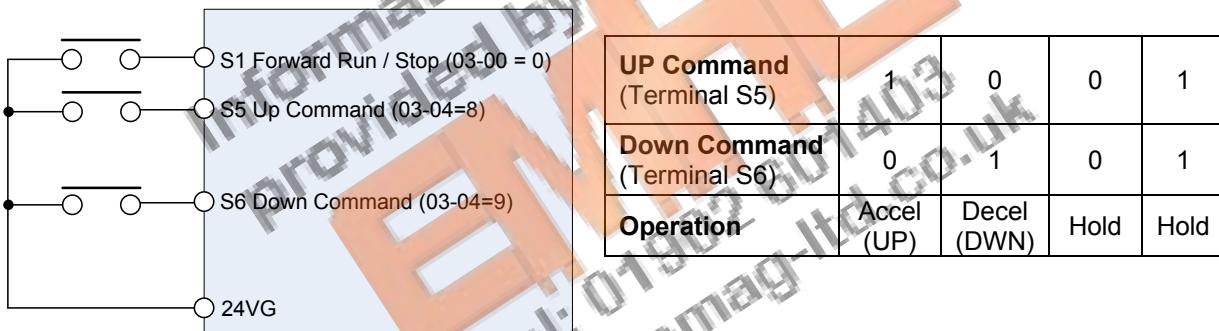

Figure 4.4.19 UP/DOWN wiring and operation example

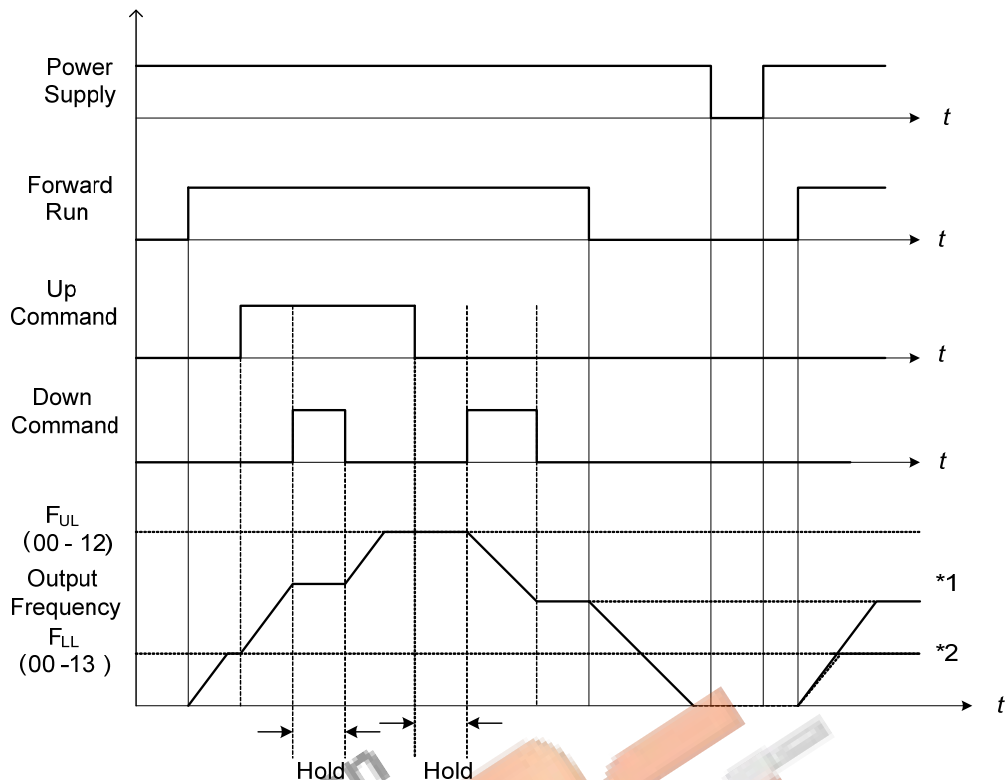

Figure 4.4.20 Up / Down command timing diagram

UP / DOWN Command Operation

When the Forward Run command is active and the UP or Down command is momentarily activated the inverter will accelerate the motor up to the lower limit of the frequency reference (00-13).

When using the UP / Down command, the output frequency is limited to the upper limit of frequency reference (00-12) and the lower limit of frequency reference (00-13).

The UP / DOWN command uses acceleration 1 or 2 / deceleration time 1 or 2 for normal operation Tacc1 / Tdec1 (00-14, 00-15) or Tacc2 / Tdec2 (00-16, 00-17).

Frequency reference retention is active when parameter 11-58 is set to 1 and the frequency reference is saved when power is lost and retrieved when power is restored.

- *1. When 11-58 = 1 and the operation command is active, the output frequency will accelerate to the previously stored frequency command.
- *2. When 11-58 = 0 and the operation command is active, the output frequency will accelerate to the lower limit of frequency reference (00-13).

03-0X =10: Acceleration/deceleration 1 selection

03-0X =30: Acceleration/deceleration 2 selection

Refer to the "multi-function digital input terminals select acceleration / deceleration time" page 4-76.

03-0X =11: Inhibit Acceleration/deceleration command (hold command)

When activated suspends the acceleration / deceleration operation and maintains the output frequency at current level.

If 11-58 = 1, the frequency reference value is saved when the acceleration/deceleration inhibit command is active the frequency reference value is saved. Deactivating the acceleration / deceleration inhibit command resumes acceleration / deceleration.

If 11-58 = 0, the frequency reference value is saved when the acceleration/deceleration inhibit command is active, the frequency reference value is saved even when powering down the inverter.

Refer to Figure 4.4.21. for an example.

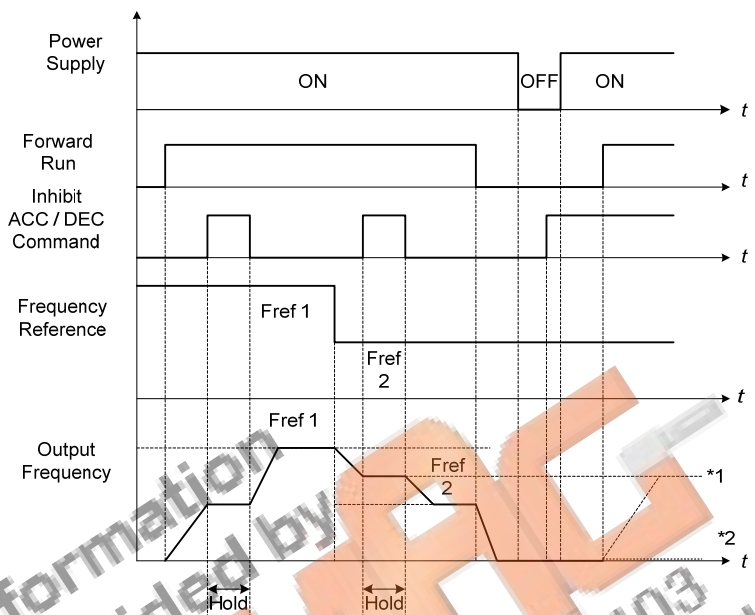

Figure 4.4.21 Inhibit acceleration / deceleration command operation

*1. When 11-58 = 1, and acceleration / deceleration inhibit command is activated, the frequency reference is stored even when powering down the inverter. When a run command is given (e.g. run forward) and the acceleration / deceleration inhibit command is active, the inverter will accelerate to the previously stored frequency reference.

*2. When 11-58 = 0, and a run command is and the acceleration / deceleration inhibit command is active, the frequency reference and output frequency will remain at zero.

03-0X =14: Emergency stop (decelerate to zero and stop)
Refer to the "deceleration time of emergency stop" of parameter 00-26

03-0X =15: External Baseblock Command (coast to stop)
Execute the base block command by the use of ON / OFF way of multi-function digital input terminal, and prohibit the inverter output.

During run: When an external base block command is activated, the keypad displays "BBn BaseBlock (Sn)", indicating the inverter output is turned off (n indicates the digital input number 1 – 8). Upon removing the base block signal, the motor will run at the frequency reference. If speed search from frequency reference is active the inverter output frequency starts from the frequency reference and searches for the coasting motor speed and continue to operate. If speed search is not active the output frequency starts at 0Hz.

During deceleration: When an external base block command is activated, the keypad displays "BBn BaseBlock (Sn)", indicating the inverter output is turned off (n indicates the digital input number 1 – 8). Upon removing the base block signal, the motor is stopped or will coast to a stop and the inverter will remains in the stop condition.

During acceleration: When an external base block command is activated, the keypad displays "BBn BaseBlock (Sn)", indicating the inverter output is turned off (n indicates the digital input number 1 – 8). Upon removing the base block signal, the motor will run at the frequency reference. If speed search from frequency reference is active the inverter output frequency starts from the frequency reference and searches for the coasting motor speed and continue to operate. If speed search is not active the output frequency starts at 0Hz.

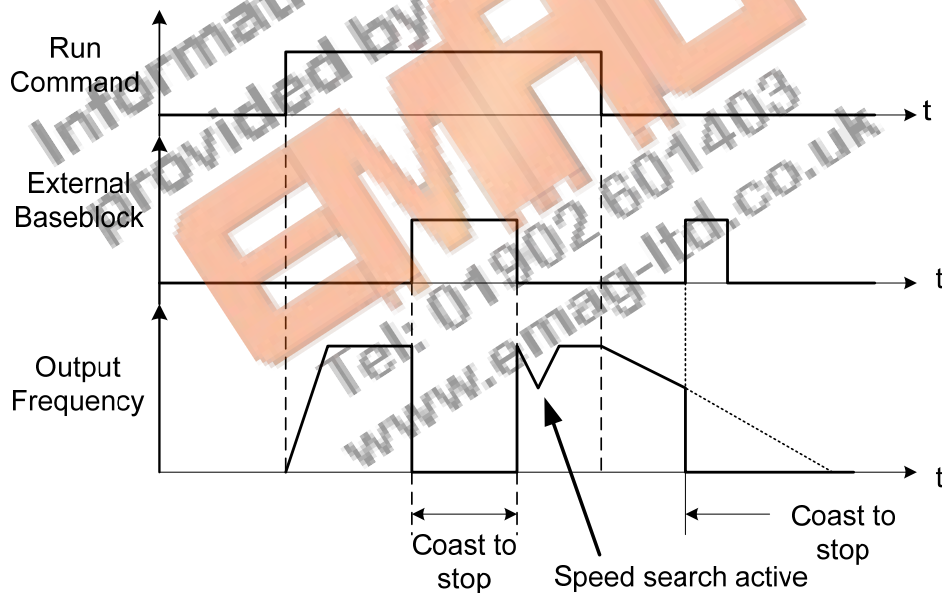

Figure 4.4.22 External base block operation

03-0X =16: PID control disabled.

03-0X =17: Fault reset

The output becomes active when the inverter trips on a fault. Upon an inverter fault the inverter output will turn off (base block) and the keypad displays the dedicated fault message.

When fault occurs, the following actions can be used to reset the fault:

1. Program one of the multi-function digital inputs (03-00 to 03-07) to 17 (reset fault) and active input.*
2. Press the reset key of the digital operator (RESET).*
3. Recycle power to the inverter. **Important Note:** If a run command is active during power-up, the inverter will start running automatically.

* To reset an active fault the run command has to be removed.

03-0X =19: Speed Search 1 (from the maximum frequency).

03-0X =34: Speed Search 2 (from the frequency command).

Refer to the "speed search" function on pages 4-169.

03-0X =20: Energy saving enabled

Manual energy savings function is set with parameters 11-12 and 11-18. For the manual energy saving operation refer to Figure 4.4.88.

03-0X =21: PID integral reset

03-0X =25: External fault

Activating the external fault input will turn off the inverter output and the motor will coast to a stop. The keypad displays the external fault message "EFn Ext. Fault (Sn)", where n is the input terminal number.

03-0X =26: 3-wire sequence (forward / reverse command)
Refer to the 3-wire operation mode in Figure 4.4.2.

03-0X =27: Local / Remote selection.

Switch the inverter frequency reference source between Local (keypad) or Remote (control circuit terminals or RS485). Use parameter 00-05 (Main frequency command source selection) and 00-02 (Run command selection) to select the remote source.

Note: In 3-wire operation terminal S1 and S2 are reserved for run/stop operation and the Local / Remote function can only be set to digital input terminals S3 to S8 (03-02 to 03-07).

Note: To switch between local and remote the inverter has to be stopped.

Input	Mode	Frequency Reference / Run/Stop Command Source
ON	Local	- Frequency reference and Run-Stop from keypad. - LEDs SEQ and REF are off.
OFF	Remote	- Frequency reference source selected by parameter 00-05 and Run-Stop source selected by parameter 00-02. - LEDs SEQ and REF are on.

03-0X =28: Remote mode selection

Switch between terminal source and communication (RS-422/RS-485) source for frequency reference and operation command.

In Remote mode, indicators of SEQ and REF are on; you can use terminals AI1 and AI2 to control the frequency command, and use terminals S1, S2 or communication terminal RS-485 to control the operation command.

Input	Mode	Frequency Reference / Run/Stop Command Source
ON	Communication	- Frequency reference and run/stop command control via communication (RS-422/RS-485).
OFF	Terminal	- Frequency reference source from AI1 / AI2 input (00-05=1) and Run-Stop command from terminals S1 / S2 (00-02=1).

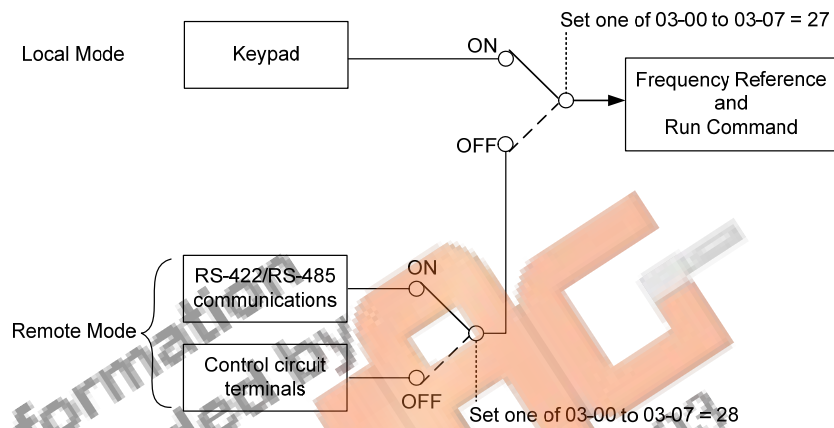

Figure 4.4.23 Remote mode operation selection

To switch the frequency reference and operation command input between communication RS-485 and control terminals the following parameters have to be set:

1. 00-05=1 (use control terminal AI1 or AI2 as reference frequency source)
2. 00-02=1 (use control terminal S1 or S2 for operation command)
3. Set one of the digital input terminals (03-02 to 03-07) to 28 (Operation selection of remote mode)

03-0X =31: Inverter overheat warning

When input is active the inverter displays warning message "OH2" and continues operation. Deactivating the input reverts back to the original display. Warning message does not require resetting the inverter.

03-0X =32: Sync command

Selects between frequency reference source from pulse input or frequency reference source selected by parameter 00-05. Refer to page 4-116 for more information.

Input	Ref. Source	Frequency Reference / Run/Stop Command Source
ON	Pulse Input	- Frequency reference set by pulse input
OFF	Parameter 00-05	- Frequency reference source selected by parameter 00-05

Note:

- Function is disabled when the Local/Remote selection (25) or Remote mode selection (26) is active.
- To switch between local and remote the inverter has to be stopped.

03-0X =33: DC braking

When input is active DC-Injection braking is enabled during start and stopping of the inverter. DC Injection braking is disabled when a run or jog command is active. Refer to the DC braking time diagram in Figure 4.4.24.

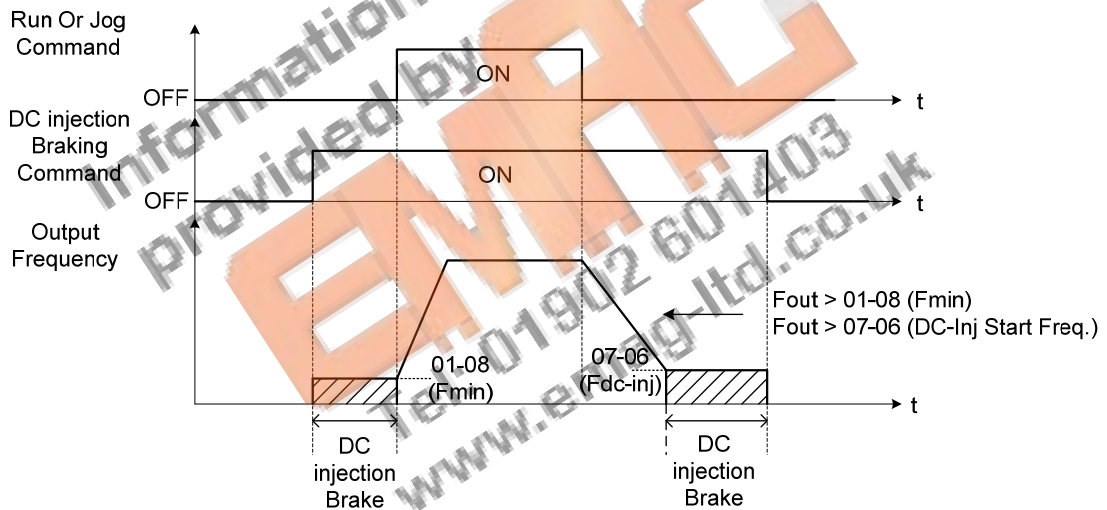

Figure 4.4.24 DC braking timing diagram

03-0X =35: Timing function

Refer to the "time function" parameter 03-37 and 03-38.

03-0X =36: PID Soft start disable

Refer to the "PID Control" function of PID function parameter group 10.

03-0X =37: Traverse operation

03-0X =38: Upper Deviation of traverse operation

03-0X =39: Lower Deviation of traverse operation

See "Wobble Frequency" function in parameter group 19

03-0X =40: Switching between motor 1 and motor 2

03-0X =42: PG disable

When input is active PG feedback is disabled and speed control is set to V/F control.

03-0X =43: PG integral reset

When input is active, reset PG speed control integral accumulator.

Note: Only applies to closed loop control modes.

03-0X =44: Mode switching between speed and torque

Active in SV (sensor vector control mode). When input is active switch control between speed and control mode. Refer to parameter group 12 for more information.

Input	Control
ON	Speed Control
OFF	Torque Control

03-0X =45: Negative torque command

When input is active reverses torque reference command. Refer to Figure 4.4.128 for more details.

03-0X =46: Zero-servo Command; Start: zero-servo operation.

When input is active starts zero-servo operation. Refer to Figure 4.4.129 for more details.

03-0X =47: Fire mode

When input is active disables all inverter warning and hardware protections. This function is commonly used in commercial applications where the inverter controls an exhaust fan and needs run to destruction in case of a fire.

03-0X =48: KEB acceleration

When input is active enables KEB (Kinetic Energy Braking) during acceleration. Refer to the parameter description of 11-47 and 11-48. Note: To enable set parameter 11-47 to a value greater than 0.

03-0X =49: Parameters write-in allowed

When input is active allows parameter to be changed.

Note: When none of the digital input terminals are set to function 49, parameter write-in protection is controlled by parameter 13-06.

Input	Parameter Save
ON	Parameters Write Enabled
OFF	Parameters Write Protected

03-0X =50: Unattended Start Protection (USP)

When input is active prevents inverter from starting automatically when a run command is present at time of power-up. Please refer to Figure 4.4.24a for more details.

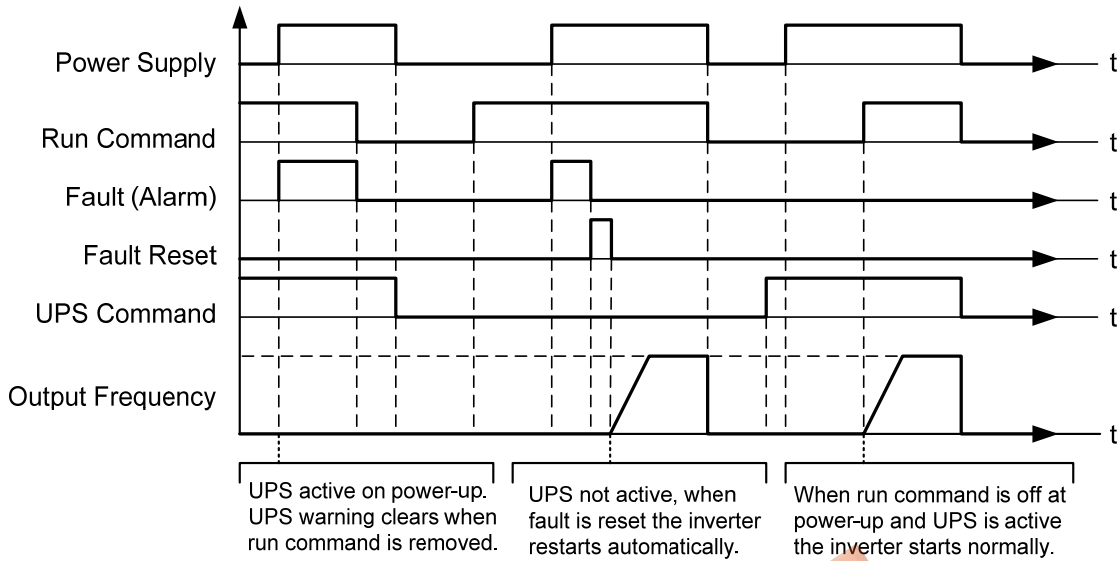

Figure 4.4.24a Unattended Start Protection

03-0X =51: Mode switching between speed and position control.
Refer to the parameter description of 21-09 ~ 21-41

Input	Control
ON	Position Control
OFF	Speed Control

03-08	(S1~S8) DI scan time
Range	0: scan time 4ms 1: scan time 8ms

Sets the digital input CPU scan time. The digital input signal needs to be present for the minimum scan time to qualify as a valid command.

Note: For noisy environments select scan time of 8ms (results in a slower response time).

03-09	Multi-function terminal S1-S4 type selection			
Range	xxx0b: S1 A	contact	xxx1b: S1 B	contact
	xx0xb: S2 A	contact	xx1xb: S2 B	contact
	x0xxb: S3 A	contact	x1xxb: S3 B	contact
	0xxxb: S4 A	contact	1xxxb: S4 B	contact

03-10	Multi-function terminal S5-S8 type selection			
Range	xxx0b: S5 A	contact	xxx1b: S5 B	contact
	xx0xb: S6 A	contact	xx1xb: S6 B	contact
	x0xxb: S7 A	contact	x1xxb: S7 B	contact
	0xxxb: S8 A	contact	1xxxb: S8 B	contact

Parameter 03-09 and 03-10 selects the digital input type between a normally open and a normally closed switch/contact.

Each bit of 03-09/03-10 presents an input:

03-09= 0 0 0 0 0: normally open switch
 s4 s3 s2 s1 1: normally close switch

03-10= 0 0 0 0 0: normally open switch
 s8 s7 s6 s5 1: normally close switch

Example: S1 and S2 wired to a normally closed contact / switch set 03-09=0011.



Do not set the operation command parameter 00-02 to terminal control before setting the digital input type. Failure to comply may cause death or serious injury.

03-11	Relay (R1A-R1C) output
03-12	Relay (R2A-R2C) output
Range	<p>0: During Running 1: Fault contact output 2: Frequency Agree 3: Setting Frequency Agree (03-13 ± 03-14) 4: Frequency detection 1 (> 03-13) 5: Frequency detection 2 (< 03-13) 6: Automatic restart 7~8: Reserved 9: Baseblock 10~11: Reserved 12: Over-Torque Detection 13~17: Reserved 18: PLC status 19: PLC control contact 20: zero speed 21: Inverter Ready 22: Undervoltage Detected 23: Source of operation command 24: Source of frequency command 25: Low torque detected 26: Frequency reference missing 27: Time function output 28: Traverse operation UP status 29: During Traverse operation status 30: Motor 2 selection 31: Zero servo completed 32: Communication control contacts</p>

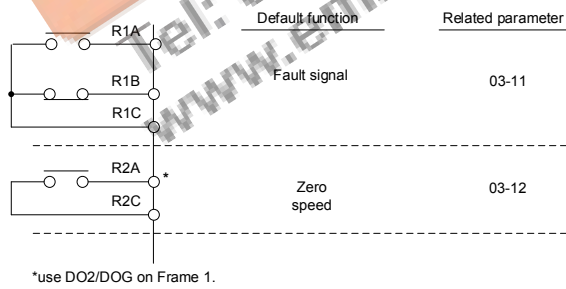

Figure 4.4.25 Multi-function digital output and related parameters

Table 4.4.8 Function table of multi-function digital output

Setting	Function		Contents	Control mode				
	Name	LCD display		V/F	V/F + PG	SLV	SV	PM SV
0	During Running	Running	ON: During running (Run Command is ON)	0	0	0	0	0
1	Fault contact output	Fault	ON: Fault contact output (except CF00 and CF01)	0	0	0	0	0
2	Frequency agree	Freq. Agree	ON: frequency agree (frequency agree width detection is set by 03-14)	0	0	0	0	0
3	Setting frequency agree	Setting Freq Agree	ON: Output frequency = allowed frequency detection level (03-13) ± frequency bandwidth (03-14)	0	0	0	0	0
4	Frequency detection 1 (> 03-13)	Freq. Detect 1	ON: In acceleration: Output frequency >= 03-13 + 03-14 OFF: In deceleration: Output frequency < 03-13	0	0	0	0	0
5	Frequency detection 2 (< 03-13)	Freq. Detect 2	OFF: During acceleration : Output frequency >= 03-13 + 03-14 ON: During deceleration: Output frequency < 03-13	0	0	0	0	0
6	Automatic restart	Auto Restart	ON: the period of automatic restart	0	0	0	0	0
7~8	Reserved	Invalid Do Func.	Reserved	-	-	-	-	-
9	Baseblock	Baseblock	ON: During baseblock	0	0	0	0	0
10~11	Reserved	Invalid Do Func.	Reserved	-	-	-	-	-
12	Over-Torque Detection	Over Torque	ON: Over torque detection is ON	0	0	0	0	0
13~17	Reserved	Invalid Do Func.	Reserved	-	-	-	-	-
18	PLC status	PLC statement	ON: when 00-02 is set to 3 (PLC operation command source)	-	-	-	-	-
19	PLC control contact	Control From PLC	ON: Control from PLC	-	-	-	-	-
20	Zero speed	Zero Speed	ON: Output frequency < Minimum output frequency (Fmin)	0	0	0	0	0
21	Inverter Ready	Ready	ON: Inverter ready (after power on, no faults)	0	0	0	0	0
22	Undervoltage Detection	Low Volt Detected	ON: DC bus voltage = < Low-voltage warning detection level (07-13)	0	0	0	0	0
23	Source of operation command	Run Cmd Status	ON: operation command from LED digital operator (local mode)	0	0	0	0	0

Setting	Function		Contents	Control mode				
	Name	LCD display		V/F	V/F + PG	SLV	SV	PM SV
24	Source of reference command	Freq Ref Status	ON: reference frequency from LED digital operator (local mode)	○	○	○	○	○
25	Low torque detected	Under Torque	ON: Low-torque detection is ON	○	○	○	○	○
26	Frequency reference missing	Ref. Loss.	ON: Reference frequency loss	○	○	○	○	○
27	Timing function output	Time Output	Set time function parameter to 03-33 and 03-34, and the time function input is set by parameter from 03-00 and 03-07	○	○	○	○	○
28	Traverse operation UP Status	Traverse UP	ON: in acceleration period (when the wobbling is in operating)	○	○	×	×	○
29	During Traverse operation status	During Traverse	ON: In the period of frequency wobbling operation (when the wobbling is in operating)	○	○	×	×	○
30	Select motor 2	Motor 2 Selection	ON: Switch to motor 2	○	○	○	○	○
31	zero servo completed	Zero Servo	ON: Zero servo function is completed	×	×	×	○	○
32	Communication control contacts	Control From Communication	ON: DO is set by communication control.	○	○	○	○	○

03-1X=0: During Running

OFF	Run command is OFF and the inverter is stopped.
ON	Run command is ON or output frequency is greater than 0.

03-1X=1: Fault contact output

Output is active during fault condition.

Note: Communication error (CF00, CF01) do not activate the fault contact.

03-1X=2: Frequency Agree

Output is active when the output frequency falls within the frequency reference minus the frequency detection width (o3-14).

03-1X=3: Setting Frequency Agree

Output is active when the output frequency falls within the frequency detection width (03-14) of the set frequency detection level (o3-13).

03-1X=4: Frequency detected 1

Output is active when the output frequency rises above the frequency detection level (03-13) + frequency detection width (o3-14) and deactivates when the output frequency falls below frequency detection level (o3-13).

03-1X=5: Frequency detected 2

Output is active when the output frequency is below the frequency detection level (03-13) + frequency detection

width (03-14) and turns off when the output frequency falls below frequency detection level.

03-1X=6: Automatic restart.

Output is active during an auto-restart operation.

03-1X=9: Baseblock (B.B.)

Output is active when the inverter output is turned off during a Baseblock command.

03-1X=12: Over torque detected (Normally Open)

Output is active during an over torque detection see parameters 08-13 ~ 08-16.

03-1X=25: Low torque detected (Normally Open)

Output is active during low torque detection see parameters 08-17 ~ 08-20.

03-1X=18: PLC status (setting =18)

Output is active when operation command parameter (00-02) is set to 3: PLC Control.

03-1X=19: PLC control contact

Output is controlled by the PLC logic

03-1X=20: Zero-speed

Output is active during zero-speed

Active	Output frequency \geq minimum output frequency (01-08, Fmin)
Off	Output frequency is \leq the minimum output frequency

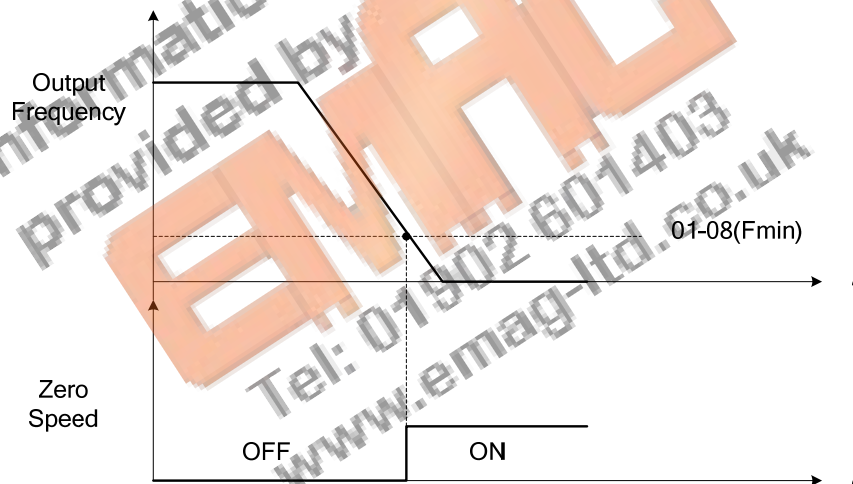

Figure 4.4.26 Zero-speed operation

03-1X=21: Inverter Ready

Output is active when no faults are active and the inverter is ready for operation.

03-1X=22: Undervoltage Detection

Output is active when the DC bus voltage falls below the low voltage detection level (07-13).

03-1X=23: Source of operation command
Output is active in local operation command.

OFF	Remote mode: 00-02 = 1 or 2, or any one of the multi-function digital input terminals (S1 to S8) set to function 5 (LOCAL / REMOTE control) is OFF. SEQ LED of the keypad is ON.
ON	Local mode: 00-02 = 0, or any one of the multi-function digital input terminals (S1 to S8) set to function 5 (LOCAL / REMOTE control) is active. SEQ LED of the keypad is OFF.

03-1X=24: Source of frequency command
Output is active in local frequency command.

OFF	Remote mode: 00-05 = 1 or 2, or any one of the multi-function digital input terminals (S1 to S8) set to function 5 (LOCAL / REMOTE control) is OFF. REF LED of the keypad is ON.
ON	Local mode: 00-05 = 0, or any one of the multi-function digital input terminals (S1 to S8) set to function 5 (LOCAL / REMOTE control) is active. REF LED of the keypad is OFF.

03-1X=26: Frequency reference missing
Output is active when the frequency reference is lost. When parameter 11-41 is set to 0 the inverter will decelerate to a stop. When parameter 11-41 is set to 1 operation will continue at the value of parameter 11-42 times the last know frequency reference.

03-1X=27: Time function output
Output is controlled by timer function see parameter 03-37 and 03-38.

03-1X=28: Traverse operation UP status
Output is controlled by frequency wobbling operation; refer to Parameter group 19 for details.

03-1X=29: During Traverse operation status
Output is controlled by the acceleration period or frequency wobbling operation, refer to Parameter group 19 for details.

03-1X=30: Motor 2 selected
Output is active when motor 2 is selected.

03-1X=31: Zero Servo Completed
Output is active when Zero-servo operation is enabled and the load is locked into position.

03-1X=32: Communication control contacts
Output is active when communication control is active.

03-13	Frequency detection Level
Set Range	0.0~400.0 Hz 0.0~1200.0 Hz (when 00-31 = 1)

03-14	Frequency detection width
Range	0.1~25.5 Hz

Frequency detection Level: set the multi-function output terminals R1A-R1C, R2A-R2C or PH1 (03-11, 03-12 or 03-28) to the desired detection level and bandwidth for use with multi-function output functions 2 to 5.

The time charts for the Frequency Agree Detection operation are shown in the following table 4.4.9.

Table 4.4.9 Frequency detection operation

Function	Detection operation of frequency confirmation	Description
Frequency agree		<p>Output is active when the output frequency falls within the frequency reference minus the frequency detection width (03-14).</p> <p>Any of the digital outputs function (03-11, 03-12 or 03-28) can be set to 3 (Frequency agree).</p>
Set frequency agree		<p>Output is active the output frequency falls within the frequency detection width (03-14) of the set frequency detection level (03-13).</p> <p>Any of the digital outputs function (03-11, 03-12 or 03-28) can be set to 3 (Set frequency agree).</p>
Output frequency detection 1		<p>Output is active when the output frequency rises above the frequency detection level (03-13) + frequency detection width (03-14) and deactivates when the output frequency falls below frequency detection level (03-13).</p> <p>Any of the digital outputs function (03-11, 03-12 or 03-28) can be set to 4 (Output frequency detection 1).</p>
Output frequency detection 2		<p>Output is active when the output frequency is below the frequency detection level (03-13) + frequency detection width (03-14) and turns off when the output frequency falls below frequency detection level.</p> <p>Any of the digital outputs function (03-11, 03-12 or 03-28) can be set to 5 (Output frequency detection 2).</p>

03-19	Relay (R1A-R2C) type
Range	xxx0b: R1 A contact xxx1b: R1 B contact xx0xb: R2 A contact xx1xb: R2 B contact

Parameter 03-19 selects the digital output type between a normally open and a normally closed contact.

Each bit of 03-19 presents an output:

03-19= 0 0 **0:** normally open contact

R2 R1 **1:** normally close contact

Example: R1 normally open and R2 normally closed contact set 03-19=xxx01.

03-27	UP / DOWN frequency maintaining selection
Range	0: Hold last set frequency when stopped 1: Set frequency to 0 when stopped 2: Allow speed changes from last set frequency when stopped

03-27=0: When the run command is removed the UP/DOWN frequency reference before deceleration is stored. The next time the run command is applied the output frequency will ramp up to the previously stored frequency reference.

03-27=1: When the run command is removed the UP/DOWN frequency reference command is cleared (set to 0). The next time the run command is applied the output frequency will start at 0.

03-27=2: UP/DOWN command is active when run command is not active.

03-28	Photo-coupler Output
Range	See function selection list parameter 03-11

03-29	Photo-coupler Output Selection
Range	xxx0b: Photo-coupler A Contact xxx1b: Photo-coupler B Contact

0 = Normally open (A), 1 = Normally closed (B)

03-30	Function setting of pulse input
Range	0: Frequency command 1: PID feedback 2: PID target value 3: Reserved

Function selects source for the pulse input.

03-31	Scale of pulse input
Range	50 ~ 32000 Hz

Pulse input scaling, 100% = Maximum pulse frequency.

03-32	Pulse input gain
Range	0.0~1000.0 %

Target value (03-03) in % = Pulse input frequency scaled to 100% based on maximum pulse frequency (03-31) times the gain (03-32) + bias (03-33).

03-33	Pulse input bias
Range	-100.0~100.0 %

Target value (03-03) in % = Pulse input frequency scaled to 100% based on maximum pulse frequency (03-31) times the gain (03-32) + bias (03-33).

03-34	Pulse input filter time
Range	0.00~2.00 Sec

* Refer to figure 4.3.5 2 for the pulse input specification.

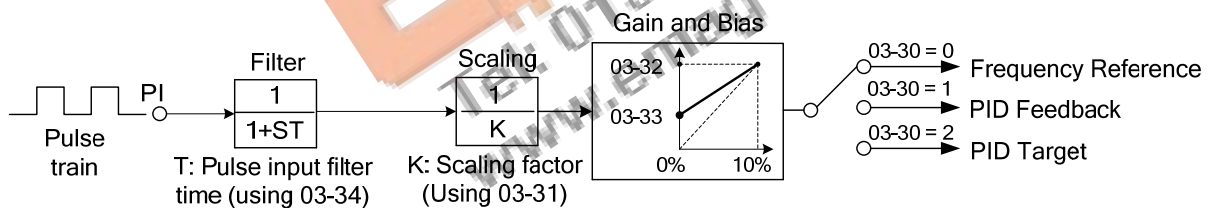

Figure 4.4.27 Pulse input adjustment

Set Pulse Input Setup as Frequency Reference

Set parameter 00-05 to 4 and 03-30 to 0 to use the pulse input terminal PI as the frequency reference source. Refer to Figure 4.3.5. for details. Next set the pulse input scaling (03-31), enter the pulse input frequency to match the maximum output frequency. Adjust the pulse input filter time in case interference or noise is encountered.

Example: Pulse train input maximum 10 kHz, set parameter 03-31 to 10000 when maximum frequency is set to 60.0Hz.

Set Pulse Input as PID feedback value

Set parameter 00-05 to 4, 03-30 to 1 and PID feedback value source 10-01 to 3, to use the pulse input terminal PI as the PID target (setpoint) value. Next set the pulse input scaling (03-31), enter the pulse input frequency to

match the maximum output frequency. Adjust the pulse input filter time in case interference or noise is encountered. Refer to Figure 4.4.28. for details.

Note: The inverter will display a SE09 "PI setting error" when 03-30 = 1 and 10-01 is not set to 3.

Set Pulse Input as PID target value

Set parameter 00-05 to 4 and 03-30 to 2 to use the pulse input terminal PI as the PID target (setpoint) value. Next set the pulse input scaling (03-31), enter the pulse input frequency to match the maximum output frequency. Adjust the pulse input filter time in case interference or noise is encountered. Refer to Figure 4.4.28. for details.

Note: The inverter will display a SE09 "PI setting error" if 03-30=0 and PID control is enabled (10-03 > 0).

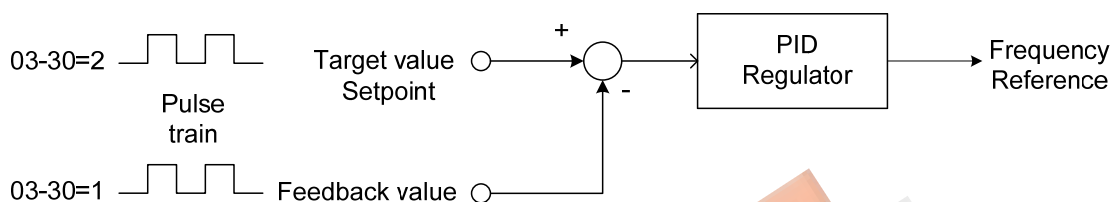

Figure 4.4.28 PID control

03-35	Function setting of pulse output
Range	1: Frequency command 2: Output frequency 3: Output frequency after the soft start 4: Motor speed 5: PID feedback 6: PID input 7: PG output

Refer to Table 4.4.10 for pulse output function selection overview.

03-36	Scale of pulse output
Range	0~32000 Hz

Pulse output scaling, 100% = Maximum pulse frequency (see table 4.4.10).

Note: When setting 03-35 to 2 (output frequency) and setting 03-36 to 0 (0 Hz), PO's pulse output and the inverter output frequency are sync.

Table 4.4.10 Pulse output function selection

03-35	Function	Screen display (LCD)	Parameter	100%
1	Frequency command	Freq Ref	12-16	01-02
2	Output frequency (Fout)	Output Freq	12-17	01-02
3	Output frequency after soft-start	Output Freq (SFS)	-	01-02
4	Motor speed (rpm)	Motor Speed	12-22	01-02
5	PID feedback	PID Feedback	12-39	01-02
6	PID input	PID Input	12-36	01-02
7	PG output	PG Pulse Output		

Note: Selection 1~4 are related to the motor speed, 5 and 6 are related to PID and 7 is related to PG.

Setup the pulse output

Use 03-36 (pulse output scale) to set the pulse output frequency to 100% signal value of the selected item.

Please refer to the figure 4.4.29.

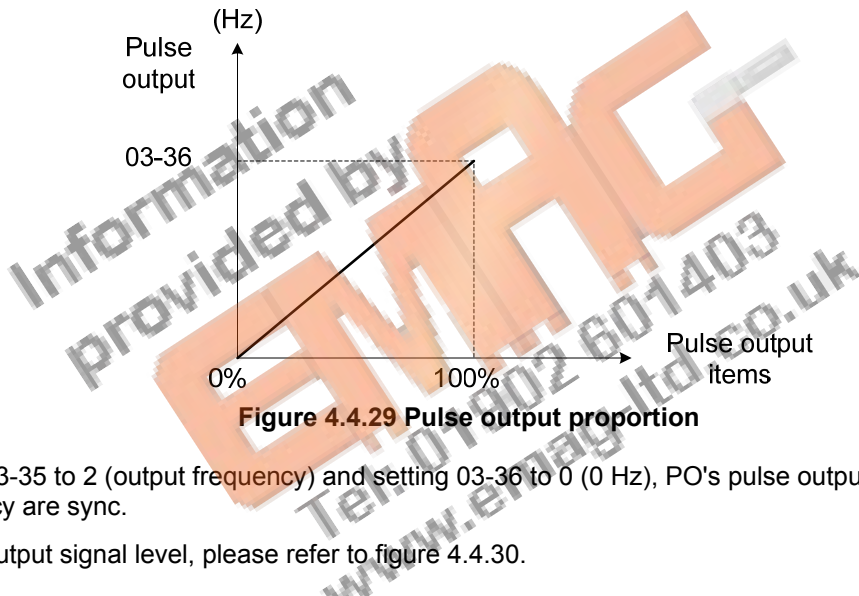

Figure 4.4.29 Pulse output proportion

When setting 03-35 to 2 (output frequency) and setting 03-36 to 0 (0 Hz), PO's pulse output and the inverter output frequency are sync.

For the pulse output signal level, please refer to figure 4.4.30.

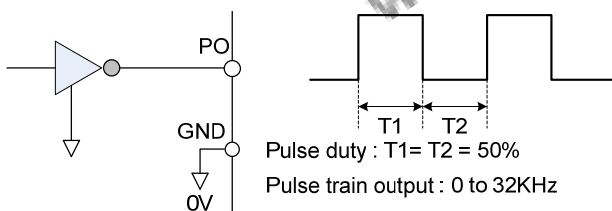

Figure 4.4.30 Pulse output signal level

When 03-35 = 7 (PG pulse monitoring output), PG pulse output scaling is internally set 1:1, independent of the scaling set in parameter 03-36.

C/B: 4KA69X492T31 includes an open collector PO output.

Application examples

Example A: Speed follower from external PG

Use the pulse input signal as frequency reference or synchronization operation. Refer to Fig. 4.4.31.

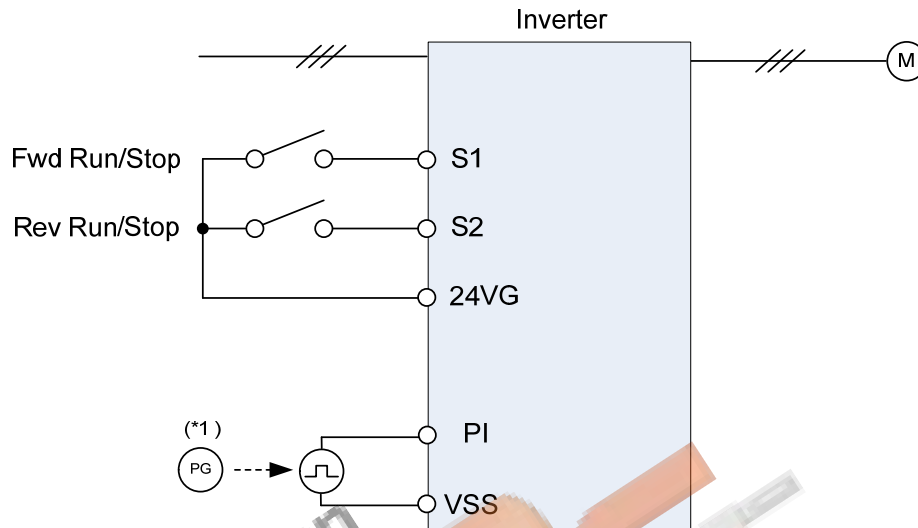

Figure 4.4.31 Speed follower from external PG

Parameter settings:

1. Frequency reference selection: 00-05=4 (Pulse input)
2. Pulse input's function selection: 03-30=0 (Frequency command)
3. Pulse input scale: 03-31 (set the number of pulse in Hz to match maximum output frequency, 01-02)
4. Pulse input gain: 03-32 (Set the input gain of the pulse frequency set by 03-31)
5. Pulse input bias: 03-33 (Set the input bias of the pulse frequency set by 03-31)
6. Pulse input's filter time: 03-34 (if the pulse input is unstable due to the interference, increase value.)

Use the forward and reverse multi-function inputs to choose motor direction.

Note: For higher accuracy use PG feedback in SV or V / f + PG control mode.

Example B: Speed follower using two inverters

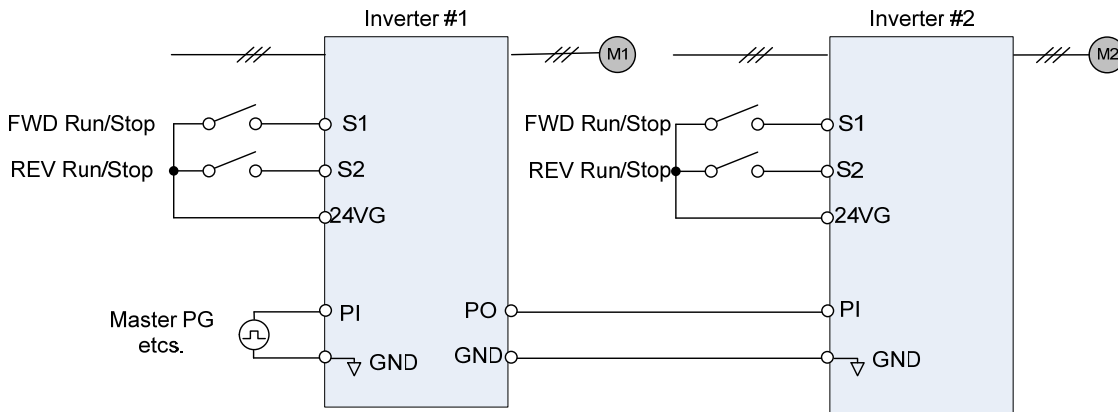

Figure 4.4.32 Speed follower using two inverters

Inverter #1 parameter settings: Frequency reference from PI signal (Master PG)

1. Frequency reference selection: 00-05=4 (Pulse input)
2. Pulse input's function selection: 03-30=0 (Frequency command)
3. Pulse input scale: 03-31 (set the number of pulse in Hz to match maximum output frequency, 01-02)
4. Pulse input gain: 03-32 (Set the input gain of the pulse frequency set by 03-31)
5. Pulse input bias: 03-33 (Set the input bias of the pulse frequency set by 03-31)
6. Pulse input's filter time: 03-34 (if the pulse input is unstable due to the interference, increase value.)
7. Pulse output function selection: 03-35=1 (Pulse output is output frequency)
8. Scale pulse output parameter 03-36 to 100% of output frequency

Inverter #1 parameter settings: Frequency reference from analog signal

1. Frequency reference selection: 00-05=1 (Analog input)
2. Pulse output function selection: 03-35=1 (Pulse output is output frequency)
3. Scale pulse output parameter 03-36 to 100% of output frequency

Inverter #2: parameter settings:

1. Frequency reference selection: 00-05=4 (Pulse input)
2. Pulse input's function selection: 03-30=0 (Frequency command)
3. Pulse input scale: 03-31 (set the number of pulse in Hz to match maximum output frequency, 01-02)
4. Pulse input gain: 03-32 (Set the input gain of the pulse frequency set by 03-31)
5. Pulse input bias: 03-33 (Set the input bias of the pulse frequency set by 03-31)
6. Pulse input's filter time: 03-34 (if the pulse input is unstable due to the interference, increase value.)

Example C: Synchronized operation using pulse input

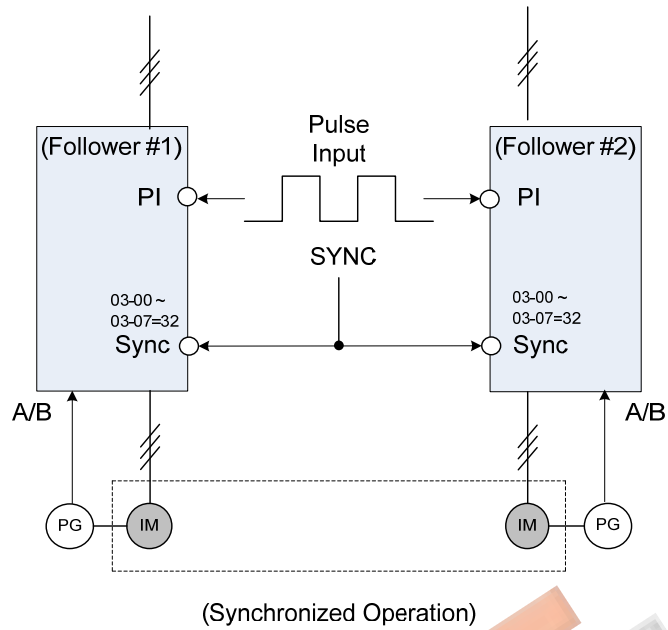

Figure 4.4.33: Synchronized operation of using pulse input

Connect pulse signal of an external pulse generator to the pulse input terminal PI of multiple follower inverters for output speed synchronization.

Follow inverter #1 and Follower #2 parameter settings:

1. Frequency reference selection: 00-05=4 (Pulse input)
2. Pulse input's function selection: 03-30=0 (Frequency command)
3. Set one of the Multi-function inputs Sn: 03-00 ~ 03-07=32 (Synchronization command)

Example D: Synchronized operation of using pulse output master follower

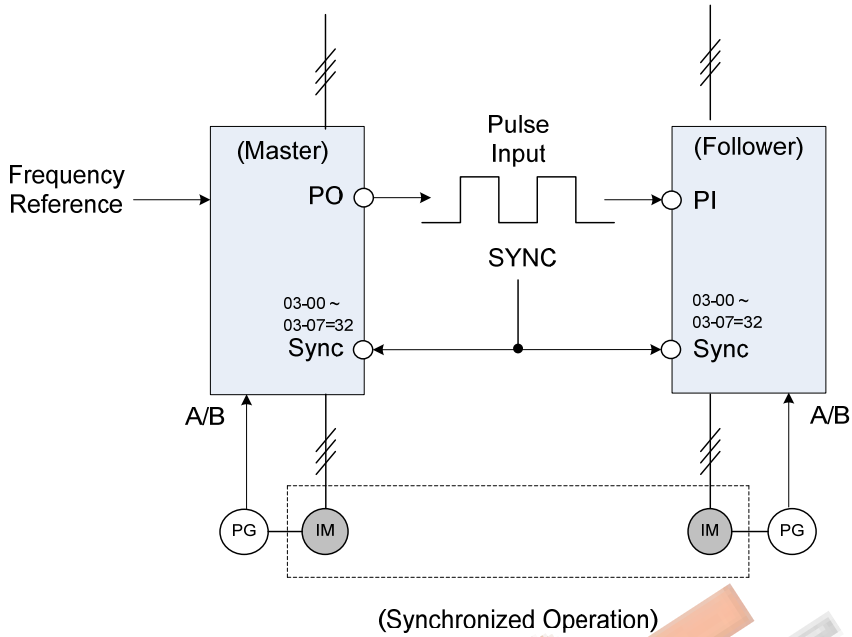

Figure 4.4.34 Synchronized operation master follower

Master inverter parameter settings:

1. Pulse output function selection: 03-35=1 (Pulse output is output frequency)
2. Scale pulse output parameter 03-36 to 100% of output frequency
3. Set one of the Multi-function inputs Sn: 03-00 ~ 03-07=32 (Synchronization command)

Follower inverter parameter settings:

1. Frequency reference selection: 00-05=4 (Pulse input)
2. Pulse input's function selection: 03-30=0 (Frequency command)
3. Pulse input scale: 03-31 (set the number of pulse in Hz to match maximum output frequency, 01-02)
4. Pulse input gain: 03-32 (Set the input gain of the pulse frequency set by 03-31)
5. Pulse input bias: 03-33 (Set the input bias of the pulse frequency set by 03-31)
6. Pulse input's filter time: 03-34 (if the pulse input is unstable due to the interference, increase value.)
7. Set one of the Multi-function inputs Sn: 03-00 ~ 03-07=32 (Synchronization command)

03-37	Timer ON delay (DIO)
Range	0.0~6000.0 Sec

03-38	Timer OFF delay (DIO)
Range	0.0~6000.0 Sec

Enable the timer function by setting one of multi-function input parameters 03-00~03-07 (S1 to S8) to 35 (timer function input) and one of multi-function output parameters 03-11, 03-12 (R1A-R1C to R4A- R4C and PH1 to PH4) to 27 (timer function output).

The timer function can be used to implement a timer relay. Use timing parameter 03-37 and 03-38 to set the timer ON / OFF delay.

Timer output is turned ON when the multi-function timer input is ON for the time specified in parameter 03-37.

Timer output is turned OFF after the multi-function timer input is turned OFF for the time specified in parameter 03-38.

Timing example:

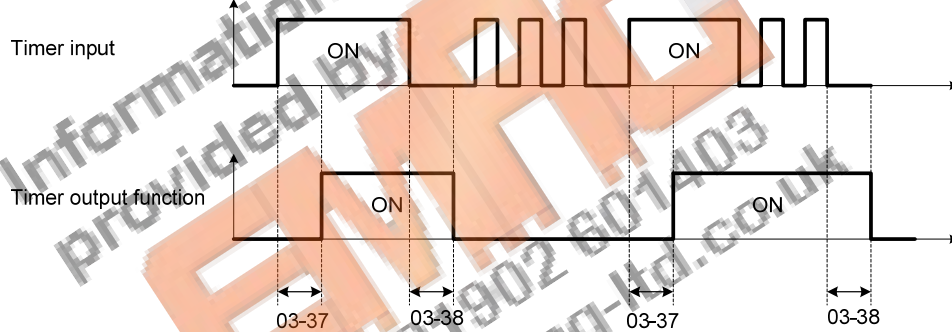

04-External Analog Input / Output Parameter

04-00	AI input signal type
Range	0: AI1: 0~10V AI2: 0~10V 1: AI1: 0~10V AI2: 4~20mA 2: AI1: -10~10V AI2: 0~10V 3: AI1: -10~10V AI2: 4~20mA
04-01	AI1 signal scanning and filtering time
Range	0.00~2.00 Sec
04-02	AI1 gain
Range	0.0~1000.0%
04-03	AI1 bias
Range	-100~100.0%
04-05	AI2 function setting
Range	0: Auxiliary frequency 1: Frequency Reference Gain 2: Frequency Reference bias 3: Output Voltage Bias 4: Coefficient of acceleration and deceleration reduction 5: DC braking current 6: Over-torque Detection Level 7: Stall prevention Level During Running 8: Frequency lower limit 9: Jump frequency 4 10: Added to AI1 11: Positive torque limit 12: Negative torque limit 13: Regenerative Torque Limit 14: Positive / negative torque limit 15: Torque command/ Torque limit (in speed control) 16: Torque command/ Torque compensation 17: No Function
04-06	AI2 signal scanning and filtering time
Range	0.00~2.00Sec
04-07	AI2 gain
Range	0.0~1000.0%
04-08	AI2 bias
Range	-100.0~1000.0%

(1) Analog Input Level Adjustment AI1, AI2 (04-02, 04-03, 04-07, 04-08)

Each analog input AI1 and AI2 has a separate gain and bias parameter associated with it.

Analog input signal AI1 can be adjusted with parameter 04-02 and 04-03; Analog input signal AI2 can be adjusted with parameter 04-07 and 04-08. Refer to Figure 4.4.35.

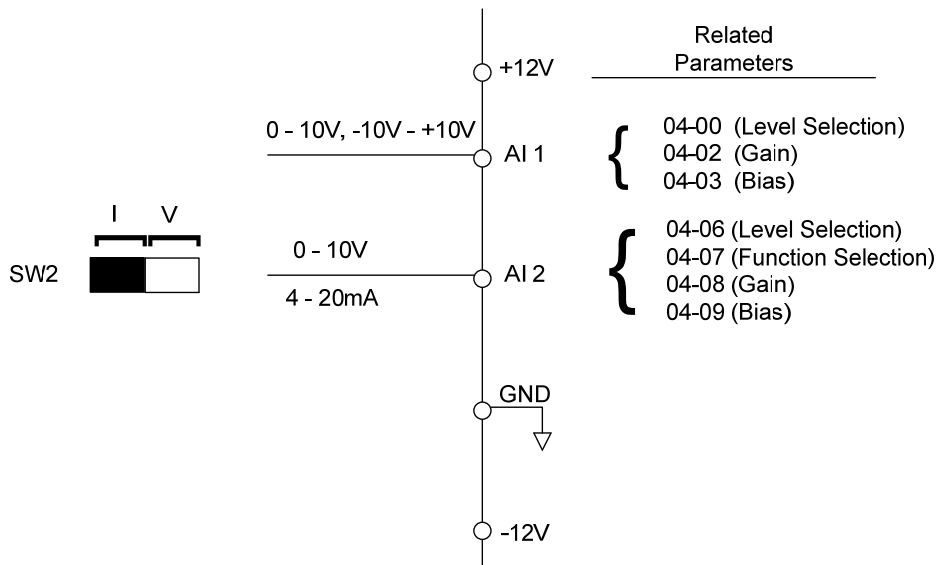

Figure 4.4.35 Analog inputs and related parameters

Gain setting: Sets the level in % that corresponds to a 10V, -10V or 20mA signal at the analog input.

Bias setting: Sets the level in % that corresponds to a 0V or 0mA signal at the analog input.

Use both gain and bias setting to scale the input signal.

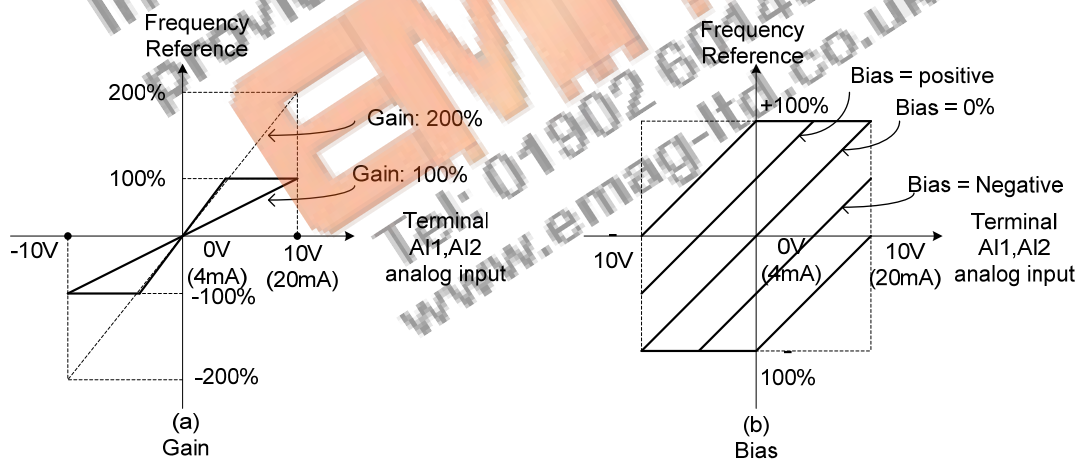

Figure 4.4.36 Gain and bias operations (for frequency reference signal)

(2) AI1 signal filtering time (04-01)

(3) AI2 signal filtering time (04-06)

All analog inputs (AI1, AI2) have a 1st order programmable input filter that can be adjusted when noise is present on each of the incoming analog signal to prevent erratic drive control.

The filter time constant (range: 0.00 to 2.00 seconds) is defined as the time that the input step signal reaches 63% of its final value.

Note: Increasing the filter time causes the drive operation to become more stable but less responsive to change to the analog input.

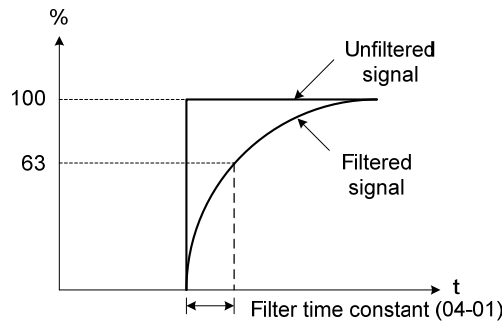

Figure 4.4.37 Filter time constant

(4) AI2 function setting (04-05)

AI2 is multi-function analog input terminal function selection. Refer to Table 4.4.11 for function overview.

Table 4.4.11 Multi-function analog input list (04-05 setting)

Setting	Function		Description	Control mode				
	Name	Screen display		V/F	V/F + PG	SLV	SV	PM SV
0	Auxiliary frequency	AUX.Freq Ref	Max Output Frequency (01-02, Fmax) = 100%	○	○	○	○	○
1	Frequency Reference Gain (FGAIN)	Freq Ref Gain	Aggregated gain = AI1 = 04-02 * FGAIN	○	○	○	○	○
2	Frequency Reference bias (FBIAS)	Freq Ref Bias	Aggregated bias = AI1 = 04-03 * FBIAS	○	○	○	○	○
3	Output Voltage Bias (VBIAS)	Output Volt Bias	Aggregate output voltage = V/F curve voltage + VBIAS	○	○	X	X	○
4	Coefficient of acceleration and deceleration reduction (K)	Tacc/Tdec Scaling	Actual acceleration and deceleration time = acceleration and deceleration time	○	○	○	○	○
5	DC braking current	DC Inj Current	Adjust the DC braking current (0 ~ 100%) based on analog input. When the inverter rated current = 100%, DC braking current 07-07 is disabled.	○	○	○	X	○
6	Over-torque detection level	Over Tq Level	Change over-torque detection level based on over-torque detection level, at this time, 08-15 is disabled.	○	○	○	○	○
7	Stall prevention Level During Running	Run Stall Level	Adjust the action level (30% ~ 200%) of stall prevention in operation based on analog input. The inverter rated current = 100%.	○	○	X	X	○
8	Frequency lower limit	Ref. Low Bound	Adjust the lower limit (0 to 100%) of frequency command based on analog input, the maximum output = 100%. The lower limit of frequency command is the greater one of the actual frequency command's lower limit 00-13 or the multi-function analog input.	○	○	○	○	○

Setting	Function		Description	Control mode				
	Name	Screen display		V/F	V/F + PG	SLV	SV	PM SV
9	Jump frequency 4	Jump Freq 4	Jump frequency 4. 100% = maximum output frequency	○	○	○	○	○
10	Added to AI1	Add to AI1	Added to AI1. 100% = maximum output frequency	○	○	○	○	○
11	Positive torque limit	Positive Tq Limit	100% = motor's rated torque	X	X	○	○	○
12	Negative torque limit	Negative Tq Limit	100% = motor's rated torque	X	X	○	○	○
13	Regenerative Torque Limit	Regen. Tq Limit	100% = motor's rated torque	X	X	○	○	○
14	Positive / negative torque limit	+/- Tq Limit	100% = motor's rated torque	X	X	○	○	○
15	Torque command/ Torque limit for speed control	Tref/Tq Limit	100% = motor's rated torque	X	X	X	○	○
16	Torque command/ Torque compensation	Tq Compensation	100% = motor's rated torque	X	X	X	○	○
17	Reserved	No Function	Reserved	○	○	○	○	○

04-05=0: Auxiliary frequency

When parameter 00-05 = 1 (main frequency from external control) the auxiliary speed reference frequency can be activated via the multi-speed input commands (see table 4.4.7). The auxiliary frequency command can be set via AI2. The maximum output frequency is set by 01-02, $F_{max} = 100\%$.

04-05=1: Frequency Reference Gain (FGAIN)

Multi-function analog input AI2 can be used to adjust the frequency reference gain of analog input AI1. The total frequency reference gain of terminal AI1 is the internal gain set by parameter 04-02 times FGAIN. The maximum frequency reference for AI1 is 100%.

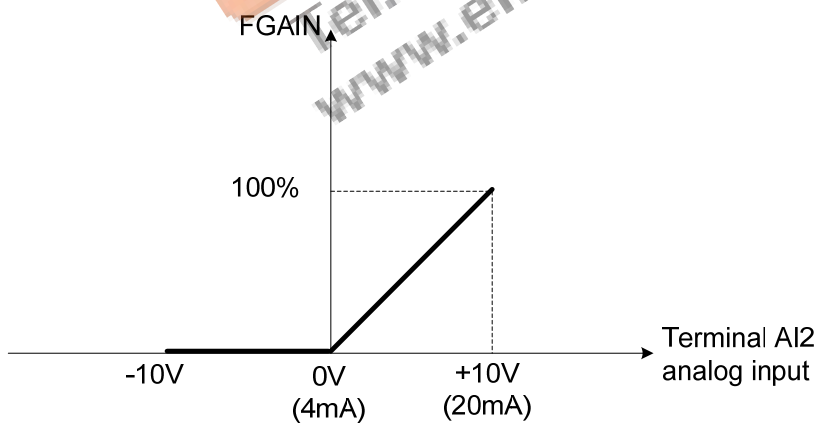

Figure 4.4.38 Frequency gain adjustment

Example:

When the internal gain of AI1 (04-02) is set to 100% and AI2 to 5V (for example FGAIN = 50%), the reference frequency of terminal AI1 will be 50%, as shown in Figure 4.4.39.

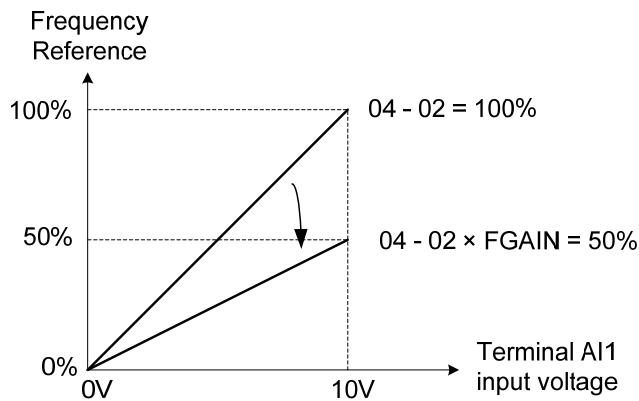

Figure 4.4.39 Frequency reference gain adjustment (example)

04-05=2: Frequency Reference bias (FBIAS)

Multi-function analog input terminal AI2 can be used to adjust the frequency reference bias of AI1. The total frequency reference bias of terminal AI1 is the sum of internal bias set by parameter 04-03 and FBIAS. The maximum frequency reference for AI1 is 100%.

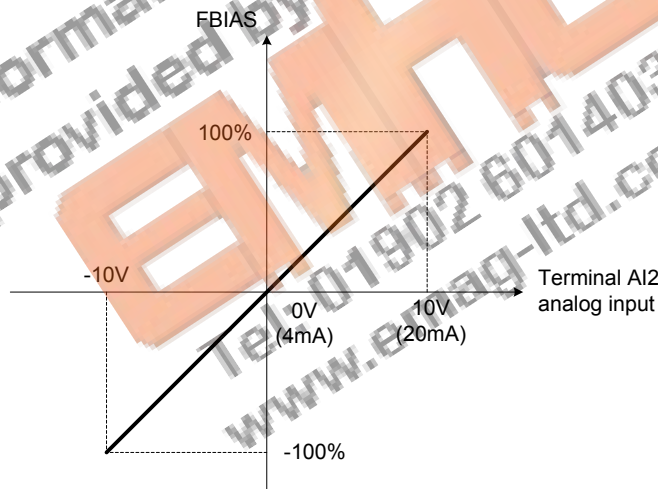

Figure 4.4.40 Bias adjustment

Example:

Terminal AI1 input is 0V, 04-02 = 100% (AI1 gain), 04-03 = 0% (AI1 bias) and terminal AI2 input is 3V. The reference frequency will be 30% as shown in Figure 4.4.41.

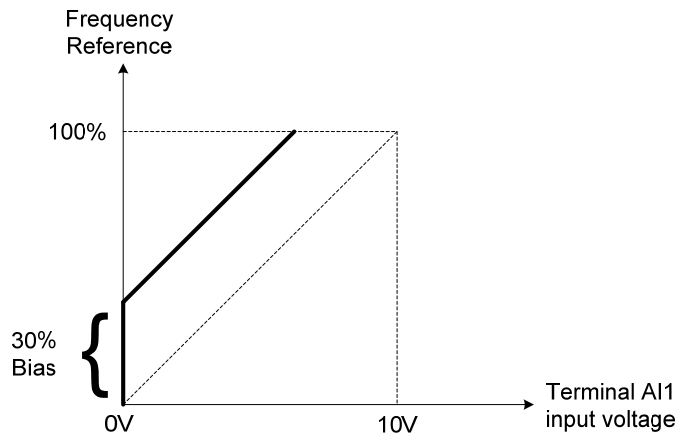

Figure 4.4.41 Frequency Reference bias adjustment (example)

04-05=3: Output Voltage Bias (VBIAS)

Multi-function analog input AI2 can be used to adjust the output voltage. The total output voltage of inverter is the sum of output voltage based on the selected V/F curve and VBIAS. The maximum output voltage is set by 01-03, $V_{max} = 100\%$.

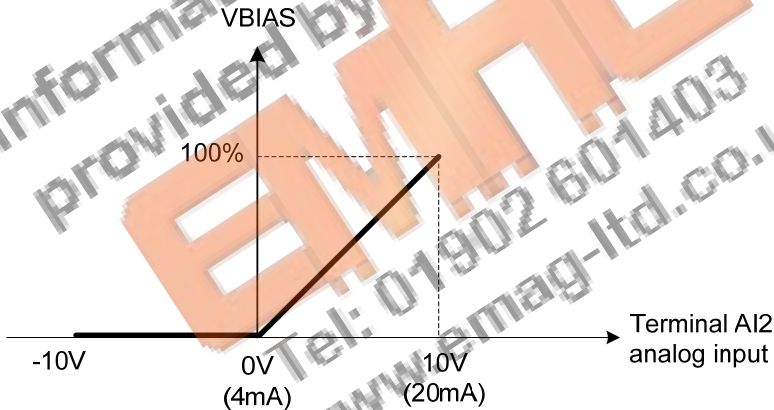

Figure 4.4.42 Bias adjustment

04-05=4: Acceleration and deceleration coefficient (K)

Multi-function analog input AI2 can be used to adjust the acceleration and deceleration time coefficient. The actual acceleration and deceleration time is calculated as follows:

$$\text{Actual accel /decel time} = \frac{\text{Acceleration / Deceleration time (00-14 ~ 00-17, 00-21, 00-24)}}{K}$$

Acceleration/ Deceleration time setting is 100% (00-14~00-17, 00-21~00-24).

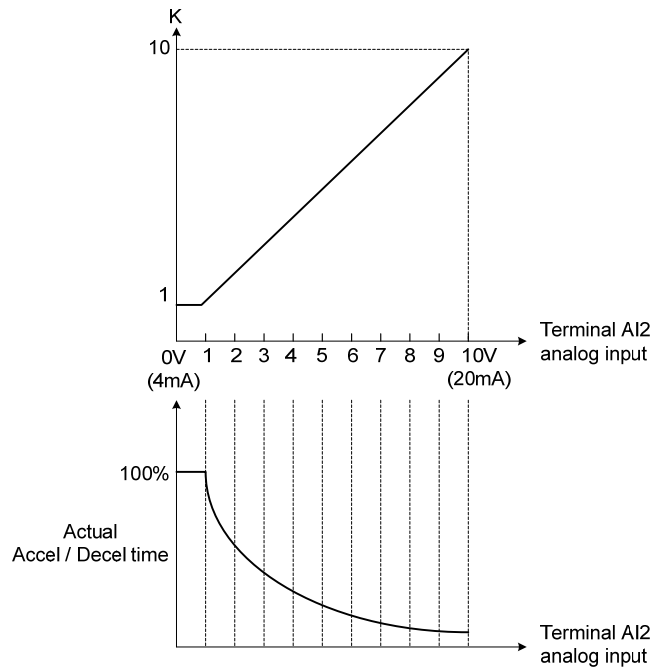

Figure 4.4.43 Acceleration / deceleration time reduction coefficient

04-05=5: DC braking current

Multi-function analog input AI2 can be used to adjust the DC Injection braking current. DC braking current parameter 07-07 setting should be set to 0% to use this function. The inverter rated current = 100%

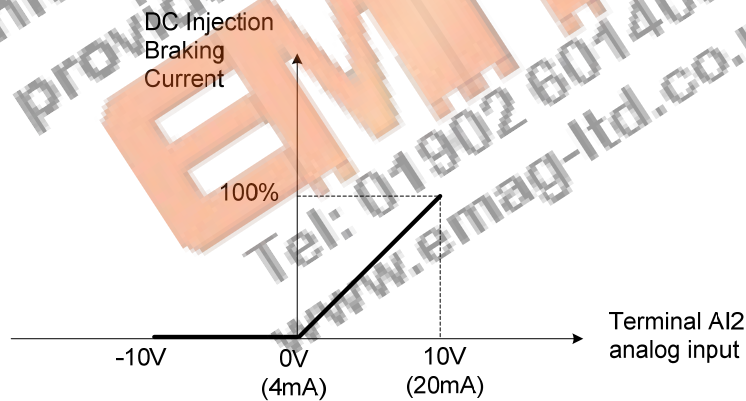

Figure 4.4.44 DC braking current adjustment

04-05=6: Over-torque detection level

Multi-function analog input AI2 can be used to adjust the over-torque detection level.

100% of inverter rated current (V/F or V/F + PG control mode)

100% motor rated torque (SLV or SV control mode)

If the multi-function analog input is used to adjust the over-torque level, the internal over-torque detection level (08-15) is disabled.

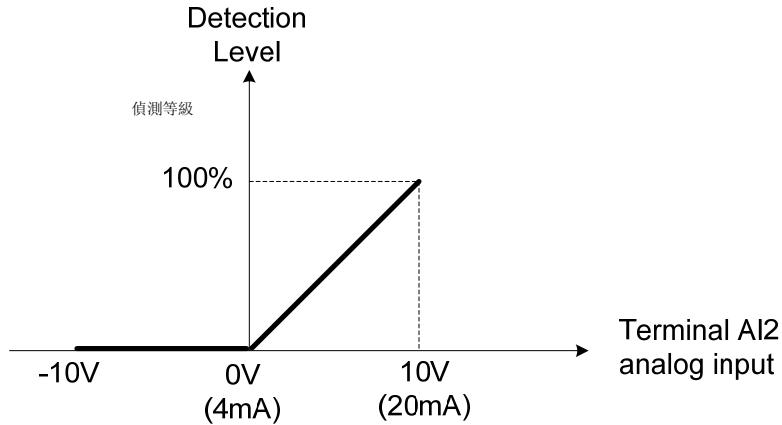

Figure 4.4.45 Over-torque/less torque detection level adjustment

4-05=7: Stall prevention level during running

Multi-function analog input AI2 can be used to adjust the stall prevention level during operation.

Inverter rated current = 100%. When AI2 is set to control stall prevention level (04-05 = 7) and parameter 08-03 (Stall prevention level during operation) is used, then the lesser of the two value becomes the active stall prevention level during operation.

Example: If the motor power is less than that of the inverter, the operation and the stall prevention of the motor will be based on the factory settings, multi-function analog input AI2 can be used to reduce the stall prevention level during operation.

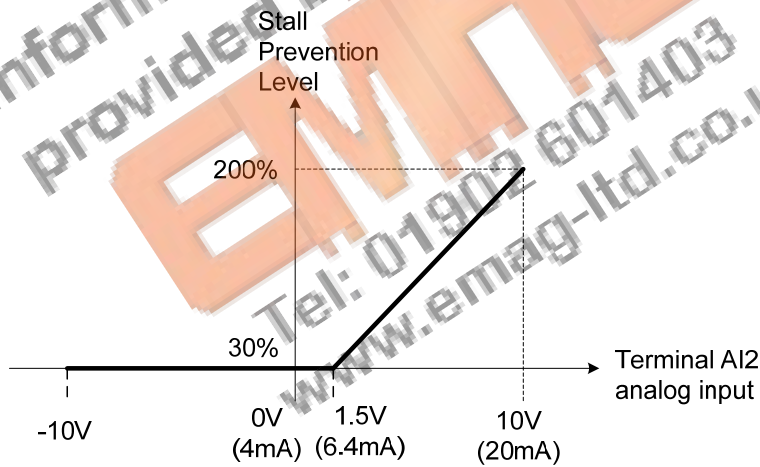

Figure 4.4.46 Stall prevention level adjustment in operation

04-05=8: Frequency lower limit

Multi-function analog input AI2 can be used to adjust the lower limit of frequency reference.

Maximum output frequency (F_{max} , 01-02) = 100%. The actual lower limit is determined by the maximum value of 00-13 (frequency lower limit) and level of the multi-function analog input AI2.

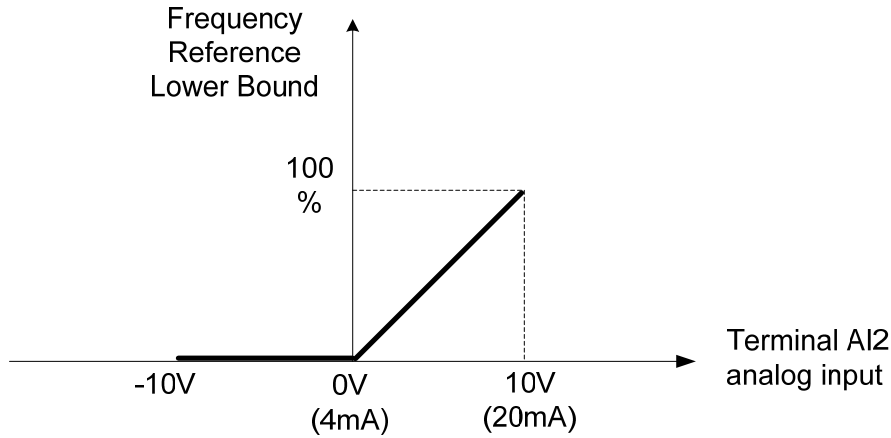
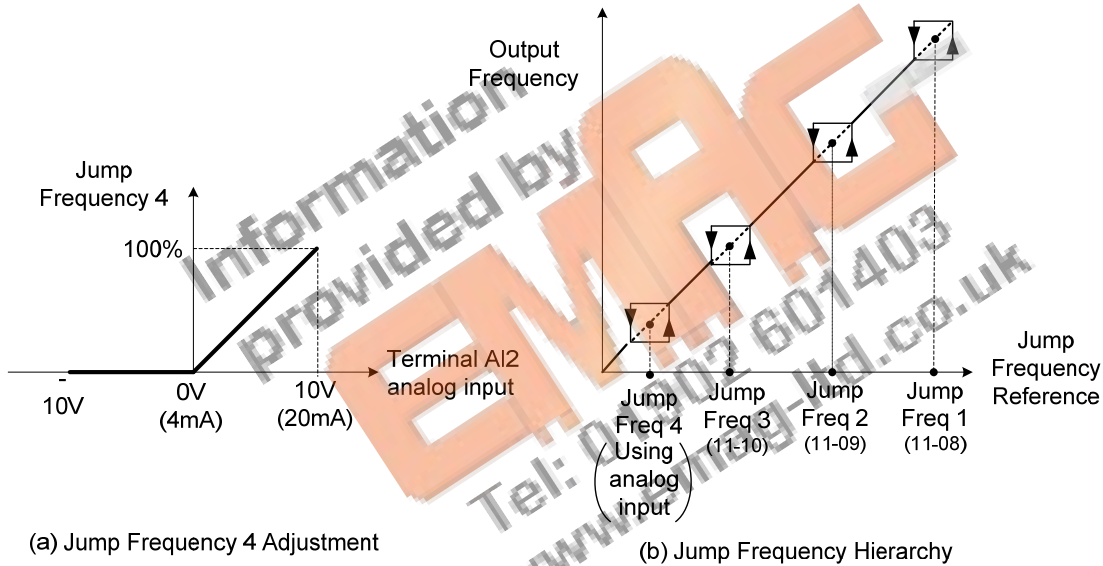

Figure 4.4.47 Adjustment of lower limit of frequency reference

04-05=9: Jump frequency 4

Multi-function analog input AI2 can be used to adjust Jump frequency 4.

Maximum output frequency (01-02, Fmax) = 100%. Setting 11-08 to 11-10 to 0.0Hz turns of the Jump frequency function.



(a) Jump Frequency 4 Adjustment

(b) Jump Frequency Hierarchy

Figure 4.4.48 Jump frequency 4 Setting Operation

04-05=10: Added to AI1

Multi-function analog input AI2 can be used as a bias level for analog input AI1.

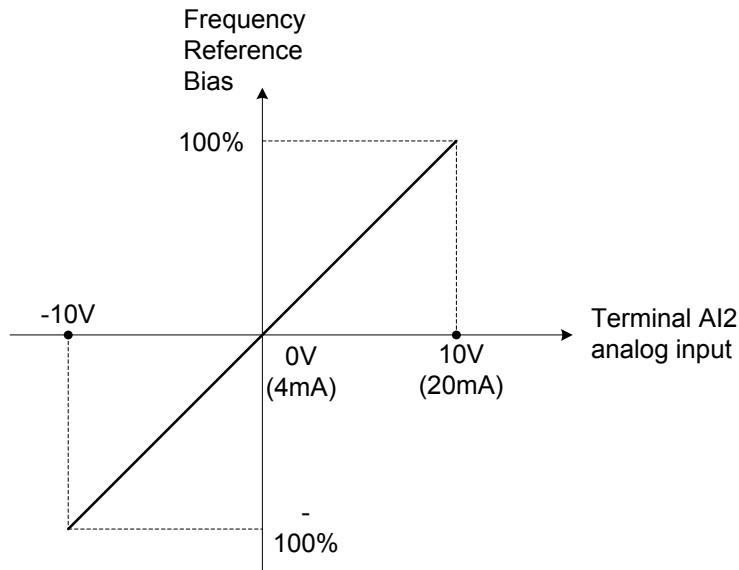

Figure 4.4.49 Operation of being added to AI1 as bias

Example:

04-02 (AI1 gain) = 100%, 04-03 (AI2 gain) = 0%, and terminal AI2 level is 2V. If input terminal AI1 is 0V, the internal reference frequency of terminal AI1 will be 20 %.

04-05=11: Positive torque limit

Multi-function analog input AI2 can be used to adjust the positive torque limit.

04-05=12: Negative torque limit

Multi-function analog input AI2 can be used to adjust the negative torque limit.

04-05=13: Regenerative torque limit

Multi-function analog input AI2 can be used to adjust the regenerative torque limit.

04-05=14: Positive / negative torque limits

Multi-function analog input AI2 can be used to adjust both the positive and negative torque limit.

For more details on torque limits, please refer to parameter group 21 - torque and position control group.

04-05=15: Torque reference / torque limit of speed control

Multi-function analog input AI2 can be used to adjust the torque reference / torque limit in closed loop vector mode.

04-05=16: Torque reference/ Torque compensation of speed control

Multi-function analog input AI2 can be used to adjust the torque reference / torque compensation in closed loop vector mode.

For more details on the torque control functions, please refer to parameter group 21 - torque and position control group.

04-11	AO1 function Setting
Range	0: Output frequency 1: Frequency command 2: Output voltage 3: DC voltage 4: Output current 5: Output power 6: Motor speed 7: Output power factor 8: AI1 input 9: AI2 input 10: Torque command 11: q -axis current 12: d-axis current 13: Speed deviation 14: Reserved 15: ASR output 16: Reserved 17: q-axis voltage 18: d-axis voltage 19~20: Reserved 21: PID input 22: PID output 23: PID target value 24: PID feedback value 25: Output frequency of the soft starter 26: PG feedback 27: PG compensation amount
04-12	AO1 gain
Range	0.0~1000.0%
04-13	AO1 bias
Range	-100.0~100.0%
04-16	AO2 function Setting
Range	See parameter 04-11
04-17	AO2 gain
Range	0.0~1000.0%
04-18	AO2 bias
Range	-100.0~100.0%

For the analog output and related parameters, refer to figure 4.4.50.

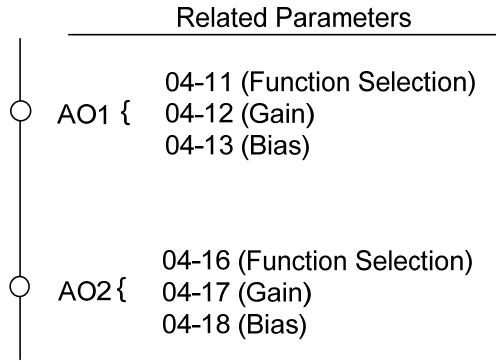

Figure 4.4.50 Analog outputs and related parameters

Analog output AO1 and AO2 adjustment (04-12, 04-13 and 04-17, 04-18)

Signal: Use parameter 04-11 to select the analog output signal for AO1 and parameter 04-16 to select the analog output signal for AO2.

Gain: Use parameter 04-12 to adjust the gain for AO1 and parameter 04-17 to adjust the gain for AO2. Adjust the gain so that the analog output (10V/20mA) matches 100% of the selected analog output signal (04-11 for AO1 and 04-16 for AO2).

Bias: Use parameter 04-13 to adjust the bias for AO1 and parameter 04-18 to adjust the bias for AO2. Adjust the bias so that the analog output (0V/4mA) matches 0% of the selected analog output signal (04-11 for AO1 and 04-16 for AO2).

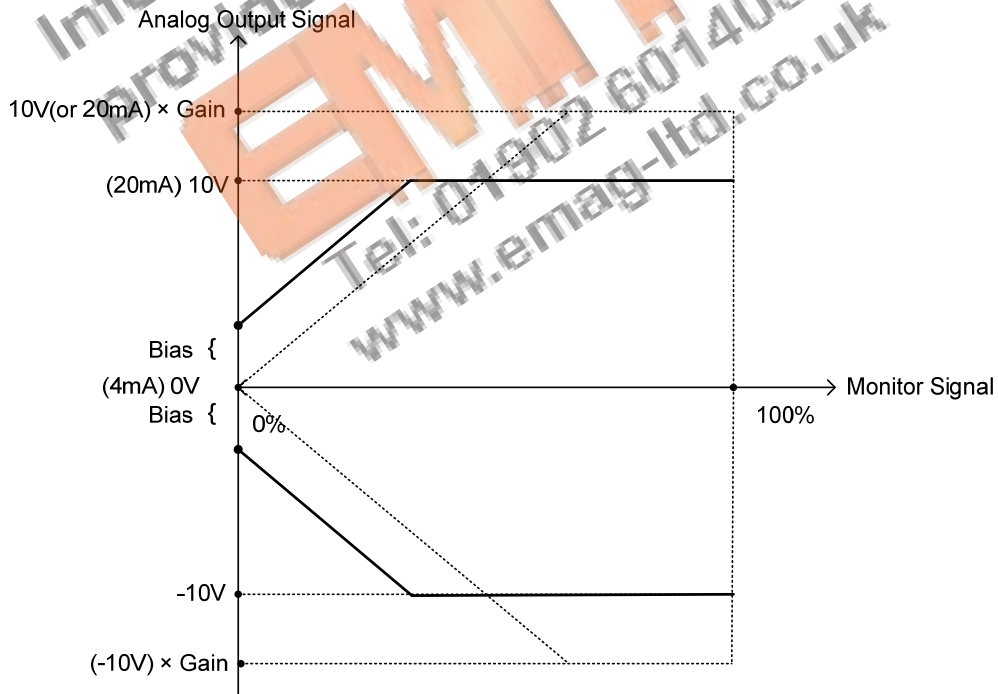

Figure 4.4.51 Analog output level adjustment

Table 4.4.12 Selection of analog output terminals function (04-11 and 04-16)

04-11, 04-16 Parameter setting	Function (Keypad display)	Monitoring Parameters Group 12
0	Output Freq	12-17
1	Freq Ref	12-16
2	Output Voltage	12-19
3	DC Voltage	12-20
4	Output Current	12-18
5	Output KW	12-21
6	Motor Speed	12-22
7	Output PF	12-23
8	AI1 Input	12-25
9	AI2 Input	12-26
10	Torque Ref	12-27
11	Current Iq	12-28
12	Current Id	12-29
13	Speed Deviation	12-30
14	Reserved	-
15	ASR Output	12-32
16	Reserved	-
17	Voltage Ref Vq	-
18	Voltage Ref Vd	-
19~20	Reserved	-
21	PID Input	12-36
22	PID Output	12-37
23	PID Setpoint	12-38
24	PID Feedback	12-39
25	Output Freq (SFS)	-
26	PG Feedback	12-33
27	PG Compensation volume	12-34

05- Multi-Speed Parameters

05-00	Acceleration and deceleration selection of multi-speed
Range	0: Acceleration and deceleration time 1 ~ 4 used. 1: Use independent acceleration and deceleration time for each multi-speed setting.

05-00=0: Standard Acceleration and deceleration times parameters 00-14 ~ 00-17 / 00-21 ~ 00-24 are used for multi-speed 0 ~ 15.

05-00=1: Each multi-speed uses a dedicated acceleration and deceleration time parameters 05-17 ~ 05-48. There are two different modes for acceleration / deceleration timing when 05-00 is set to 1, see time example on the next page.

Acceleration time calculation formula

$$\text{Time it takes to reach set frequency} = \frac{\text{Acceleration time} \times (\text{set frequency} - \text{output frequency})}{\text{Maximum output frequency}}$$

Deceleration time calculation formula

$$\text{Time it takes to reach set frequency} = \frac{\text{Deceleration time} \times (\text{output frequency} - \text{set frequency})}{\text{Maximum output frequency}}$$

Maximum output frequency: Parameter 01-00=F, maximum output frequency set by 01-02, 01-00 ≠ F, maximum output frequency determined by V/F curve selected (50.0 / 60.0 / 90.0 / 120.0 / 180.0).

Example: 01-00=01 (50Hz (maximum output frequency)), 05-02=10 Hz (multi-step speed 0), 05-17=5.0s (Acceleration time), 05-18=20.0 sec. (Deceleration time).

Acceleration time calculation formula

$$\text{Time it takes to reach set frequency} = \frac{5.0 \times 10 \text{ Hz}}{50 \text{ Hz}} = 1.0 \text{ sec.}$$

Deceleration time calculation formula

$$\text{Time it takes to reach set frequency} = \frac{20.0 \times 10 \text{ Hz}}{50 \text{ Hz}} = 4.0 \text{ sec.}$$

Example: Acceleration / deceleration timing when 05-00 is set to 1. In this example the following parameters are set:

- 00-02=1 (External Terminal Operation)
- 03-00=0 (Terminal S1: Forward /Stop)
- 03-01=1 (Terminal S2: Reversal /Stop)
- 03-02=2 (Terminal S3: Speed 1)
- 03-03=3 (Terminal S4: Speed 2)
- 03-03=4 (Terminal S5: Speed 3)

Acceleration / Deceleration Calculation Mode 1:

If the run command is cycled on and off, acceleration and deceleration time (a ~ f) is calculated based on the active speed command as follows:

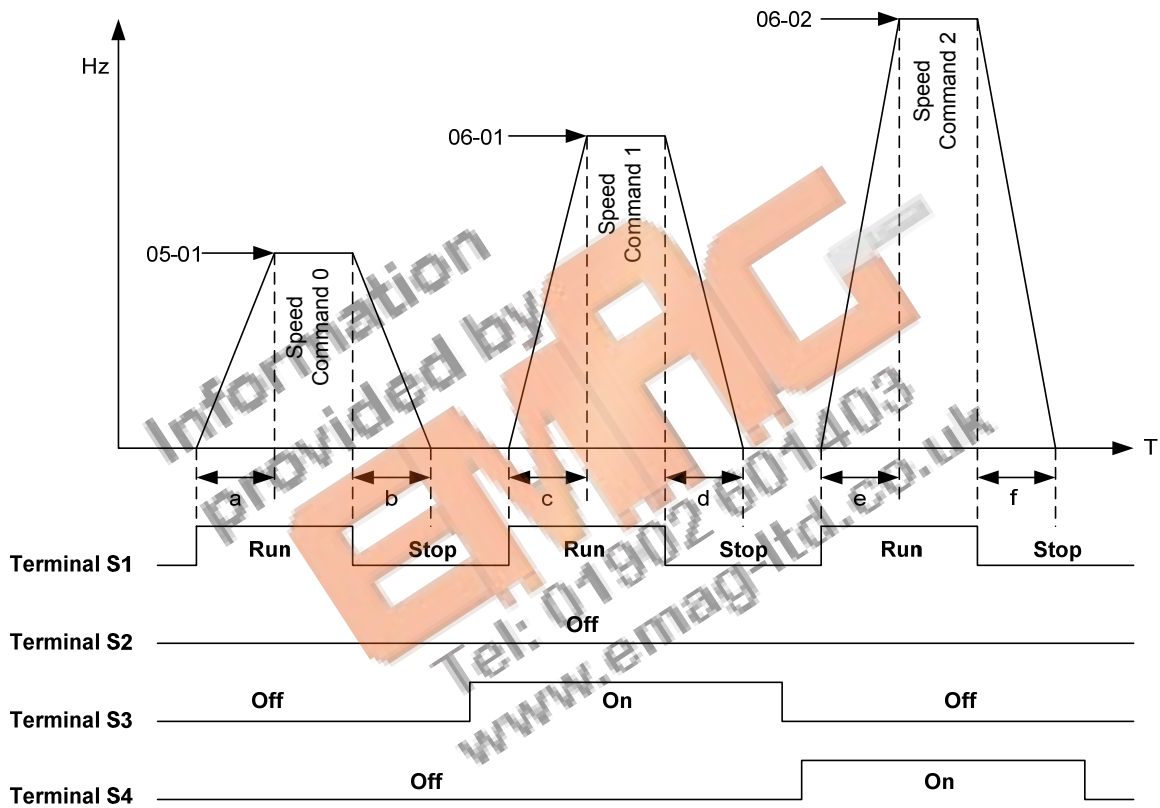

$$\begin{aligned}
 a &= \frac{(05-17) \times (05-01)}{(01-02)} & b &= \frac{(05-18) \times (05-01)}{(01-02)} & c &= \frac{(05-19) \times (06-01)}{(01-02)} \text{ in sec.} \\
 d &= \frac{(05-20) \times (06-01)}{(01-02)} & e &= \frac{(05-21) \times (06-01)}{(01-02)} & f &= \frac{(05-22) \times (06-02)}{(01-02)} \text{ in sec.}
 \end{aligned}$$

Acceleration / Deceleration Calculation Mode 2:

If the run command is remains on, acceleration and deceleration time (a ~ f) is calculated based on the active speed command as follows:

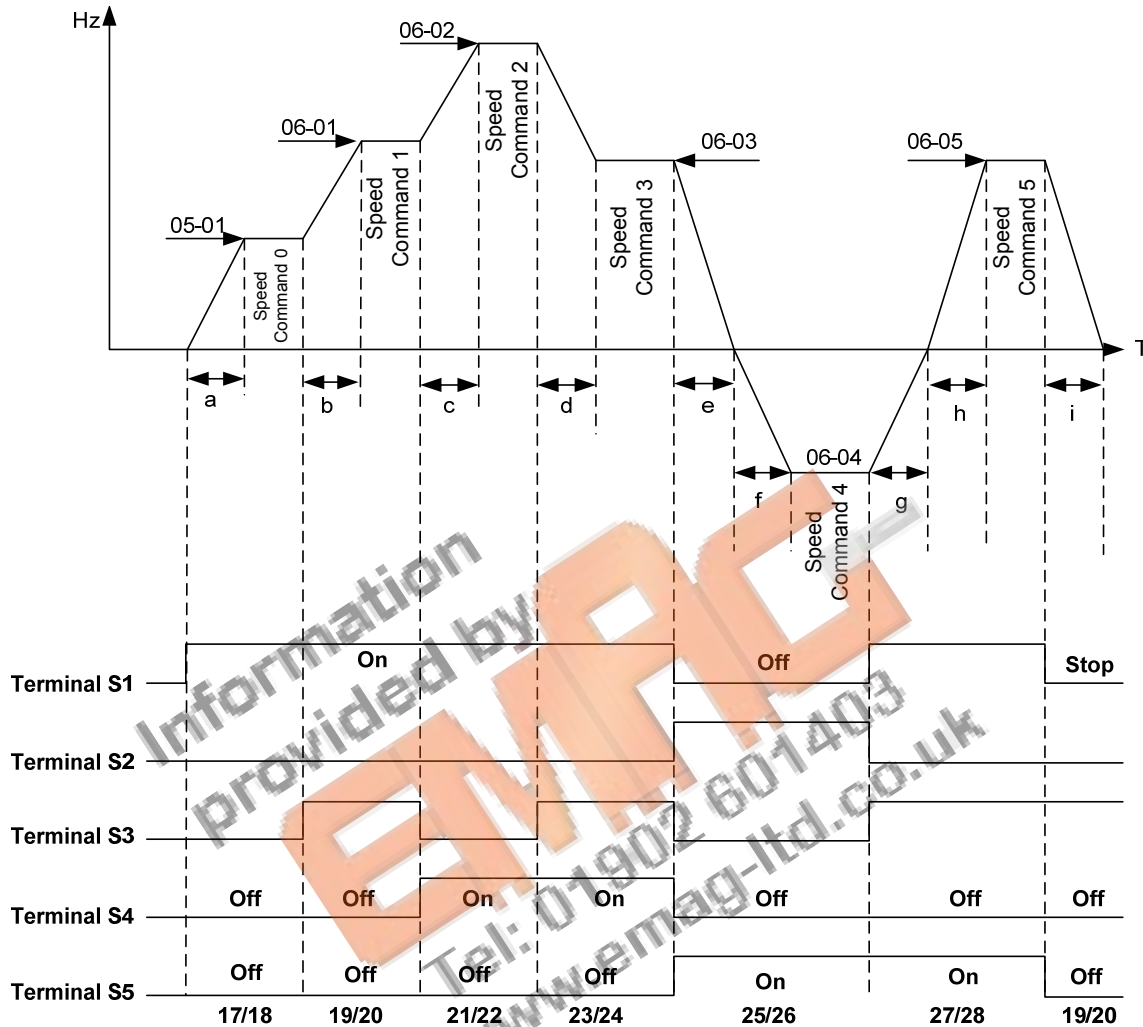

$$a = \frac{(05-17) \times (05-01)}{(01-02)} \quad b = \frac{(05-19) \times [(06-02)-(05-01)]}{(01-02)} \quad c = \frac{(05-21) \times [(06-02) - (06-01)]}{(01-02)} \text{ in sec.}$$

$$d = \frac{(05-24) \times [(06-02) - (06-03)]}{(01-02)} \quad e = \frac{(05-26) \times (06-03)}{(01-02)} \quad f = \frac{(05-25) \times (06-04)}{(01-02)} \text{ in sec.}$$

$$g = \frac{(05-27) \times (06-04)}{(01-02)} \quad h = \frac{(05-27) \times (06-05)}{(01-02)} \quad i = \frac{(05-19) \times (06-05)}{(01-02)} \text{ in sec.}$$

05-01	Frequency setting of speed-stage 0
Range	0.0~400.00 Hz 0.0~1200.0 Hz (00-31 = 1)
05-17	Acceleration time setting for multi speed 0
Range	0.0~6000.0 Sec
05-18	Deceleration time setting for multi speed 0
Range	0.0~6000.0 Sec
05-19	Acceleration time setting for multi speed 1
Range	0.0~6000.0 Sec
05-20	Deceleration time setting for multi speed 1
Range	0.0~6000.0 Sec
05-21	Acceleration time setting for multi speed 2
Range	0.0~6000.0 Sec
05-22	Deceleration time setting for multi speed 2
Range	0.0~6000.0 Sec
05-23	Acceleration time setting for multi speed 3
Range	0.0~6000.0 Sec
05-24	Deceleration time setting for multi speed 3
Range	0.0~6000.0 Sec
05-25	Acceleration time setting for multi speed 4
Range	0.0~6000.0 Sec
05-26	Deceleration time setting for multi speed 4
Range	0.0~6000.0 Sec
05-27	Acceleration time setting for multi speed 5
Range	0.0~6000.0 Sec
05-28	Deceleration time setting for multi speed 5
Range	0.0~6000.0 Sec
05-29	Acceleration time setting for multi speed 6
Range	0.0~6000.0 Sec
05-30	Deceleration time setting for multi speed 6
Range	0.0~6000.0 Sec
05-31	Acceleration time setting for multi speed 7
Range	0.0~6000.0 Sec

05-32	Deceleration time setting for multi speed 7
Range	0.0~6000.0 Sec
05-33	Acceleration time setting for multi speed 8
Range	0.0~6000.0 Sec
05-34	Deceleration time setting for multi speed 8
Range	0.0~6000.0 Sec
05-35	Acceleration time setting for multi speed 9
Range	0.0~6000.0 Sec
05-36	Deceleration time setting for multi speed 9
Range	0.0~6000.0 Sec
05-37	Acceleration time setting for multi speed 10
Range	0.0~6000.0 Sec
05-38	Deceleration time setting for multi speed 10
Range	0.0~6000.0 Sec
05-39	Acceleration time setting for multi speed 11
Range	0.0~6000.0 Sec
05-40	Deceleration time setting for multi speed 11
Range	0.0~6000.0 Sec
05-41	Acceleration time setting for multi speed 12
Range	0.0~6000.0 Sec
05-42	Deceleration time setting for multi speed 12
Range	0.0~6000.0 Sec
05-43	Acceleration time setting for multi speed 13
Range	0.0~6000.0 Sec
05-44	Deceleration time setting for multi speed 13
Range	0.0~6000.0 Sec
05-45	Acceleration time setting for multi speed 14
Range	0.0~6000.0 Sec
05-46	Deceleration time setting for multi speed 14
Range	0.0~6000.0 Sec
05-47	Acceleration time setting for multi speed 15
Range	0.0~6000.0 Sec
05-48	Deceleration time setting for multi speed 15
Range	0.0~6000.0 Sec

06-Automatic Program Operation Parameters

06-00	Automatic operation mode selection
Range	<p>0: Disable</p> <p>1, 4: Execute a single cycle operation. Restart speed is based on the previous stopped speed.</p> <p>2, 5: Execute continuous cycle operation. Restart speed is based on the previous cycle stop speed.</p> <p>3, 6: After completion of a single cycle, the on-going operation speed is based on the speed of the last stage. Restart speed is based on the previous stopped speed</p> <p>1 to 3: After a stop the inverter will start with the incomplete step when the run command is re-applied.</p> <p>4 to 6: After a stop the inverter will start with the first step of the cycle when the run command is re-applied.</p>

Automatic operation mode uses frequency reference parameters 05-01, 06-01~06-15, operation time parameters 06-16 ~ 06-31 and direction of operation parameters 06-32~06-47.

Note: The automatic operation mode is disabled when any of the following functions are enabled:

- Frequency wobbling function
- PID function
- Parameters 06-16 to 06-31 are set to 0.

Notes:

- When automatic operation mode is enabled multi-step speed reference command 1~4 (03-00~03-07=2~5) is disabled.
- Frequency of multi-step speed 0 is set by 05-01.
- Acceleration/deceleration time is set by parameter 00-14 and 00-15 in automatic operation mode.

Automatic operation frequency reference settings	
06-01	Frequency setting of speed-stage 1
06-02	Frequency setting of speed-stage 2
06-03	Frequency setting of speed-stage 3
06-04	Frequency setting of speed-stage 4
06-05	Frequency setting of speed-stage 5
06-06	Frequency setting of speed-stage 6
06-07	Frequency setting of speed-stage 7
06-08	Frequency setting of speed-stage 8
06-09	Frequency setting of speed-stage 9
06-10	Frequency setting of speed-stage 10
06-11	Frequency setting of speed-stage 11
06-12	Frequency setting of speed-stage 12
06-13	Frequency setting of speed-stage 13
06-14	Frequency setting of speed-stage 14
06-15	Frequency setting of speed-stage 15
Range	0.00~400.00 Hz 0.0~1200.0Hz (00-31 = 1)

Automatic operation time settings	
06-16	Operation time setting of speed-stage 0
06-17	Operation time setting of speed-stage 1
06-18	Operation time setting of speed-stage 2
06-19	Operation time setting of speed-stage 3
06-20	Operation time setting of speed-stage 4
06-21	Operation time setting of speed-stage 5
06-22	Operation time setting of speed-stage 6
06-23	Operation time setting of speed-stage 7
06-24	Operation time setting of speed-stage 8
06-25	Operation time setting of speed-stage 9
06-26	Operation time setting of speed-stage 10
06-27	Operation time setting of speed-stage 11
06-28	Operation time setting of speed-stage 12
06-29	Operation time setting of speed-stage 13
06-30	Operation time setting of speed-stage 14
06-31	Operation time setting of speed-stage 15
Range	0.0~6000.0 Sec

Automatic operation direction settings	
06-32	Operation direction selection of speed-stage 0
06-33	Operation direction selection of speed-stage 1
06-34	Operation direction selection of speed-stage 2
06-35	Operation direction selection of speed-stage 3
06-36	Operation direction selection of speed-stage 4
06-37	Operation direction selection of speed-stage 5
06-38	Operation direction selection of speed-stage 6
06-39	Operation direction selection of speed-stage 7
06-40	Operation direction selection of speed-stage 8
06-41	Operation direction selection of speed-stage 9
06-42	Operation direction selection of speed-stage 10
06-43	Operation direction selection of speed-stage 11
06-44	Operation direction selection of speed-stage 12
06-45	Operation direction selection of speed-stage 13
06-46	Operation direction selection of speed-stage 14
06-47	Operation direction selection of speed-stage 15
Range	0: Stop, 1: Forward, 2: Reverse

Example 1: Automatic operation mode – Single cycle

In this example the inverter executes a single cycle and then stops.

Parameter Settings:

- 06-00 = 1 or 4 (Single cycle operation)
- 06-32~06-34= 1 (Forward for multi-step speed 0 - 2)
- 06-35= 2 (Reversal for multi-step speed 3)
- 06-36~06-47= 0 (Stop for multi-step speed 4 - 15)
- 05-01= 15 Hz (Multi-step speed 0:15 Hz)
- 06-01= 30 Hz (Multi-step speed 1:30 Hz)
- 06-02= 50 Hz (Multi-step speed 2:50 Hz)
- 06-03= 20 Hz (Multi-step speed 0:20 Hz)
- 06-16= 20 sec (Multi-step speed 0:20 sec)
- 06-17= 25 sec (Multi-step speed 1:25 sec)
- 06-18= 30 sec (Multi-step speed 2:30 sec)
- 06-19= 40 sec (Multi-step speed 3:40 sec)

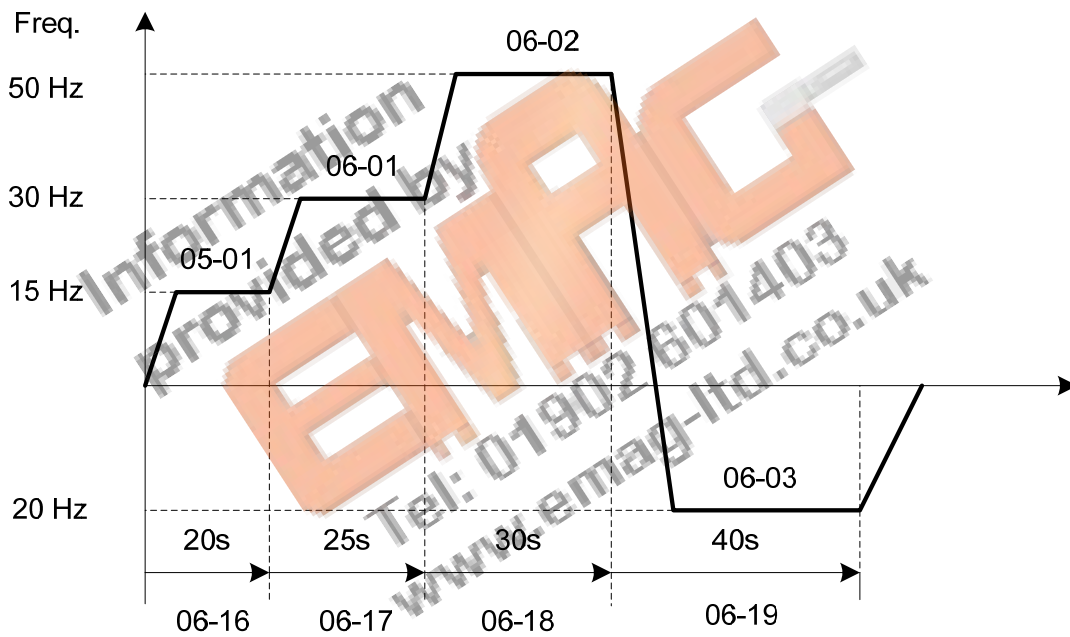

Figure 4.4.52 Single cycle automatic operation (stop)

Example 2: Automatic operation mode – Continuous cycle

In this example the inverter repeats the same cycle.

Parameter Settings:

06-00 = 2 or 5 (Continuous cycle operation)
06-01~06-47= Enter the same setting as that of Example 1.

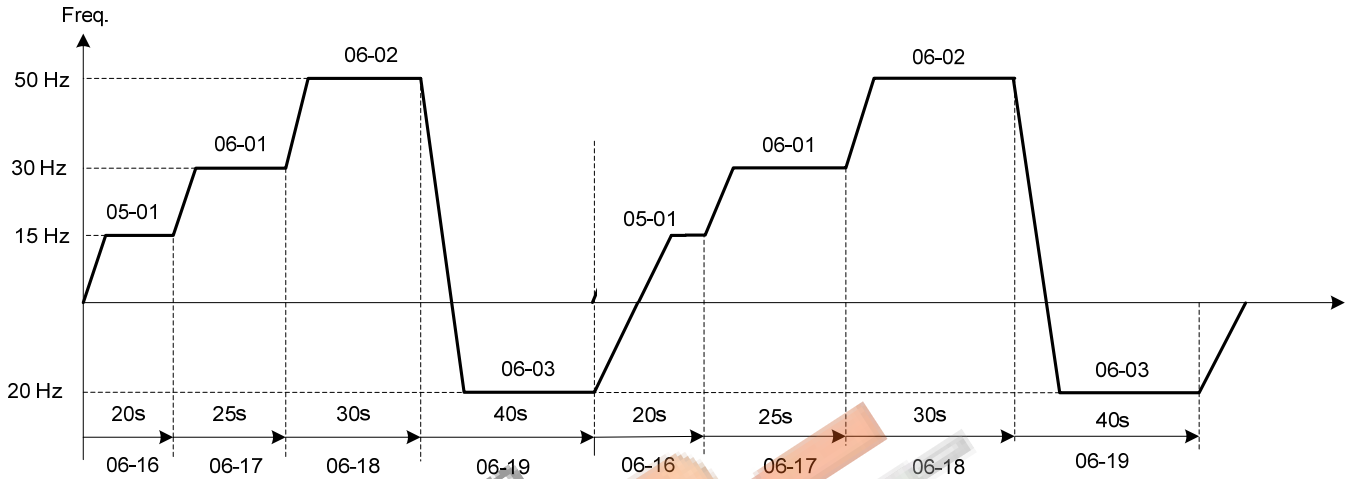

Figure 4.4.53 Periodic automatic operation

Information provided by
EMAG
Tel: 01902 601403
www.emag-ltd.co.uk

Example 3: Automatic operation mode – Single cycle and continue running at last speed of the cycle

In this example the inverter executes a single cycle and continue running at last speed of the cycle.

Parameter Settings:

- 06-00= 3 or 6 (Single cycle operation)
- 06-32~06-35= 1 (Forward)
- 06-36~06-47= 0
- Other parameter = Enter same setting as that of Example 1.

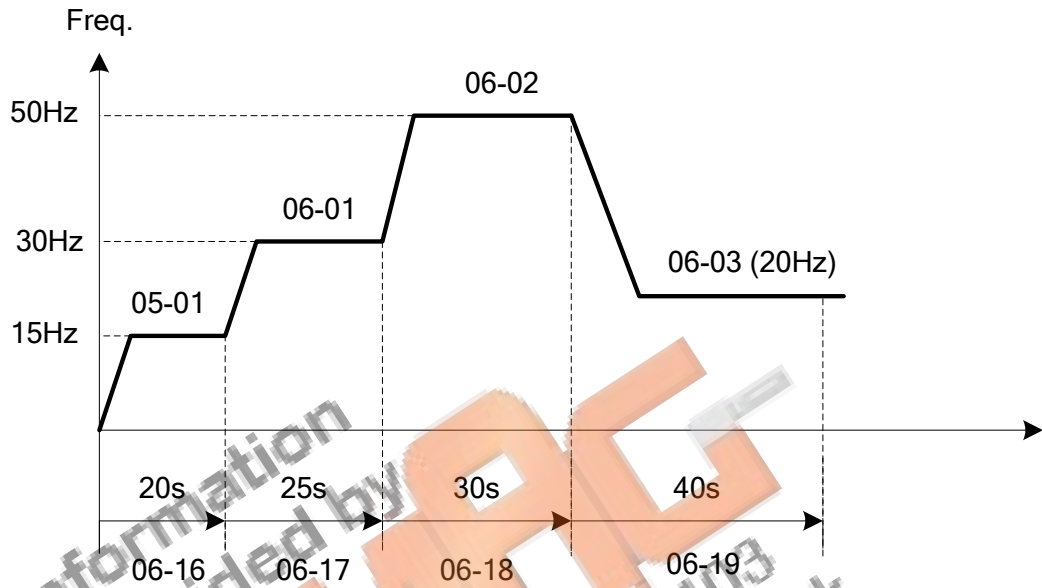

Figure 4.4.54 Single cycle automatic operation (continuous)

06-00= 1 to 3:

After a stop the inverter will start with the incomplete step when the run command is re-applied.

06-00= 4 to 6:

After a stop the inverter will start with the first step of the cycle when the run command is re-applied.

06-00	1 to 3	06-00	4 to 6
Output Frequency	<p>Operation Command: RUN STOP RUN</p> <p>Output Frequency: (Graph showing a cycle that is cut off by the STOP command and then resumes from the point where it was cut off.)</p> <p>Continue with incompleted step cycle</p>	<p>Operation Command: RUN STOP RUN</p> <p>Output Frequency: (Graph showing a cycle that is cut off by the STOP command and then restarts from the beginning of the cycle.)</p> <p>Start new cycle</p>	

07- Start/Stop Parameters

07-00	Momentary Power Loss/Fault Restart Selection
Range	0: Disable 1: Enable

07-00=0: Inverter trips on “UV” fault if power loss time is greater than 8ms.

07-00=1: Inverter resumes operation after a momentary power loss while running.

07-01	Fault reset time
Range	0~7200 Sec

07-01 = 0 sec.: Automatic restart time interval uses minimum baseblock time (07-18).

07-01 <07-18: Automatic restart time interval uses minimum baseblock time (07-18).

07-01 > 07-18: Automatic restart time interval uses fault reset time (07-01).

Refer to Figure 4.3.56 for setting automatic restart interval.

07-02	Number of restart attempts
Range	0~10

Automatic restart operation:

- a) Fault is detected. The inverter turn off the output, displays the fault on the keypad and waits for the minimum baseblock time parameter 07-18 to expire before accepting another run / automatic restart command.
- b) After the minimum baseblock time (07-18) has expired, the active fault is reset and a speed search operation is performed. The time between each fault restart attempt is set by parameter 07-01.
- c) When the total number of restart attempts exceed the number of automatic restart attempts set in parameter 07-02, the inverter will turn off the output and the fault contact is activated.

When the automatic restart function is enabled the internal automatic restart attempt counter is reset based on the following actions:

1. No fault occurs in 10 minutes or longer after the automatic restart
2. Reset command to clear fault via input terminal or using the keypad
3. Power to the inverter is turned off and back on again

The automatic restart function can be used for the following faults. Please note that when the fault is not listed in the table the inverter will not attempt an automatic restart.

OC (over current)	OL1 (motor overload)
GF (ground failure)	OL2 (Inverter overload)
FU (DC fuse is opened)	OT (Over-torque detection)
OV (overvoltage)	UT (Under torque detection)
UV (under voltage)	OPL (Output phase loss)
IPL (input phase loss)	
OH (overheat warning)	

Multi-function digital output R1A-R1C, R2A-R2C can be programmed to activate during an automatic reset attempt, refer to parameter 03-11 and 03-12.

Please refer to Figure 4.4.55 for the automatic restart operation.

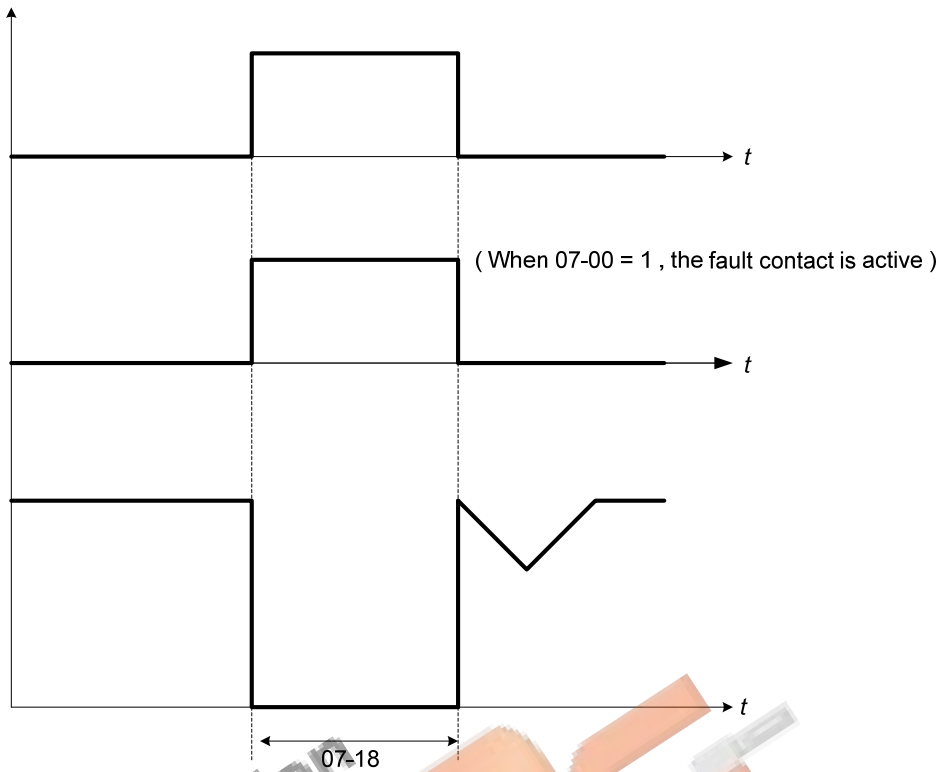

Figure 4.4.55 Auto-restart operation.

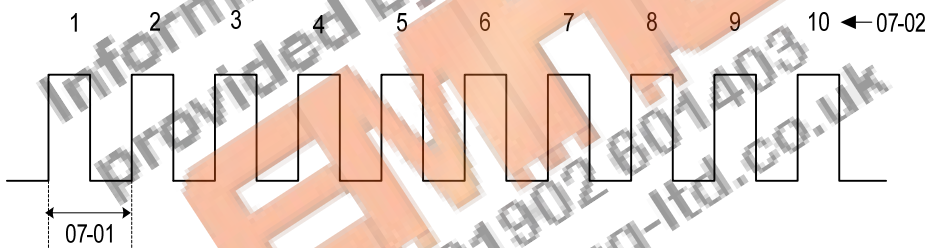

Figure 4.4.56 Automatic restart operation

Warning - Excessively use of the automatic restart function will damage the inverter.

07-06	DC injection braking starting frequency
Range	0.0~10.0 Hz

DC injection braking start frequency is the level the output frequency has to reach before DC braking injection function is activated.

07-07	DC injection braking current
Range	0~100 %

DC Injection braking current as percentage of the inverter rated current. Increasing this level will increase the amount of heat generated by the motor windings. Do not set this parameter higher than the level necessary to hold the motor shaft.

07-08	DC injection braking time at stop
Range	0.00~10.00 Sec

Duration of DC injection braking during a stop operation. DC injection braking at stop is disabled when parameter 07-08 is set to 0 sec.

07-16	DC injection braking time at start
Range	0.00~10.00 Sec

Duration of DC injection braking during a start operation. DC injection braking at start is disabled when parameter 07-16 is set to 0 sec.

DC Injection Braking Operation

When DC Injection braking is active DC voltage is applied to the motor, increasing the braking current and resulting in an increase in the strength of the magnetic field trying to lock the motor shaft.

To enable DC injection braking during a start operation set the DC injection braking current (07-07) and the DC injection braking time (07-16) at start to a value greater than 0. DC injection braking at start can be used to prevent "wind milling effect" in fan applications.

To enable DC injection braking during a stop operation set the DC injection braking current (07-07) and the DC injection braking time at stop (07-08) to a value greater than 0.

Notes:

- When parameter 07-16 is set to 0 sec. the inverter will start from the minimum output frequency.
- Increasing the DC braking time (07-08, 07-16) can reduce the motor stop time.
- Increasing the DC braking current (07-07) can reduce the motor stop time.
- During stop operation: If the DC braking start frequency < minimum output frequency (01-08), DC braking is activated when the output frequency reaches the minimum output frequency level.
- DC Injection braking cannot be used in sensor vector control (SV).

For DC braking operation, please refer to Figure 4.4.57.

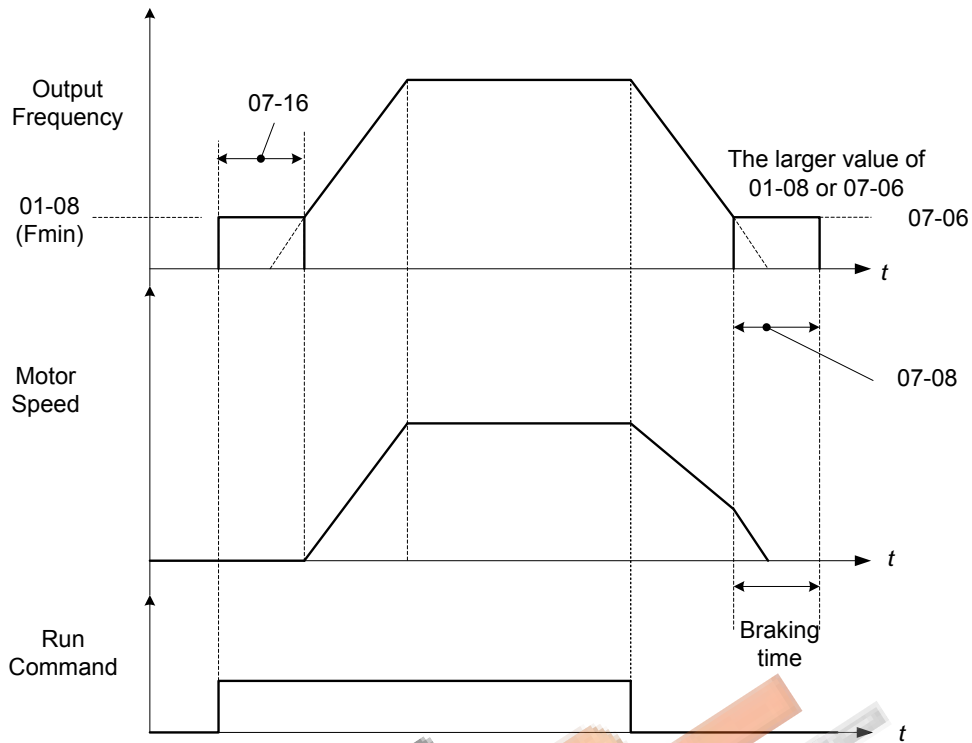

Figure 4.4.57 DC braking operation

DC braking operation can be controlled via any one of the multi-function input terminals (03-00 to 07) function 33. Refer to figure 4.4.57 for DC braking operation.

DC braking current can be controlled via the multi-function analog input (04-05) function 5. Refer to Figure 4.4.44.

Information provided by
EMAG
 Tel: 01902 601403
 www.emag-ltd.co.uk

07-09	Stop mode selection
Range	0: Deceleration to stop 1: Coast to stop 2: DC braking to stop 3: Coast to stop with timer

When a stop command is issued the inverter stops according to the stop mode selected. There are four types of stop modes,

Note: DC braking stop (2) and coast to stop with timer (3) are not available in SV mode.

07-09=0: Deceleration to stop

When a stop command is issued, the motor will decelerate to the minimum output frequency (01-08) F_{min} and then stop. Deceleration rate depends on the deceleration time (factory default: 00-15).

When the output frequency reaches the DC braking stop frequency (07-06) or the minimum output frequency (01-08), DC injection braking is activated and the motor stops.

$$\text{Deceleration time} = \frac{\text{Output frequency when stop command is issued}}{\text{Maximum output frequency } F_{max} \text{ (01-02)}} \times \text{deceleration time setting}$$

Note: S curve setting will add to the overall stop time

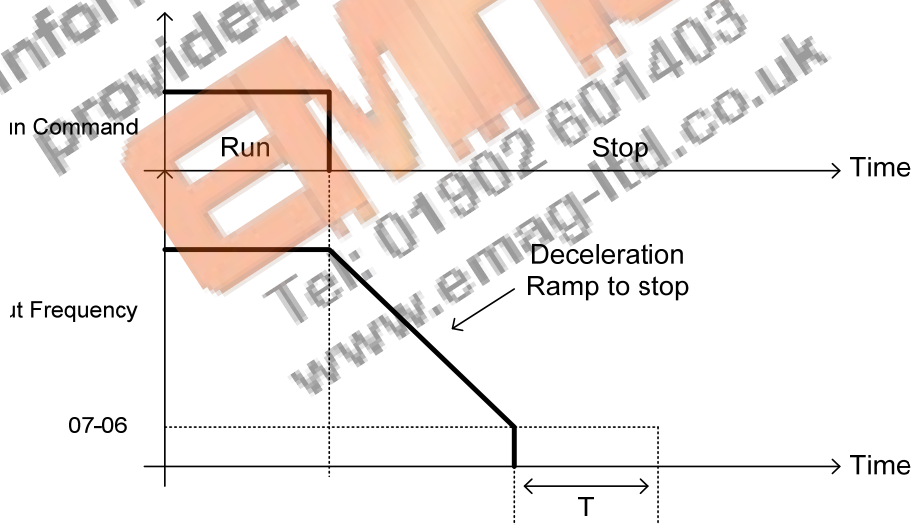

T: DC Braking Time at stop (07-08)

Figure 4.4.58 Deceleration to stop

07-09=1: Coast to stop

When a stop command is issued, the motor will coast to a stop. Stop time depends on motor load and friction of the system.

The inverter waits for the time set in the minimum baseblock time (07-18) before accepting the next run command.

In SLV mode (00-00=2) the speed search function is automatically enabled upon the next run command.

Note: When using a mechanical brake set parameter 07-26 to 1 (Software version 1.3 or later).

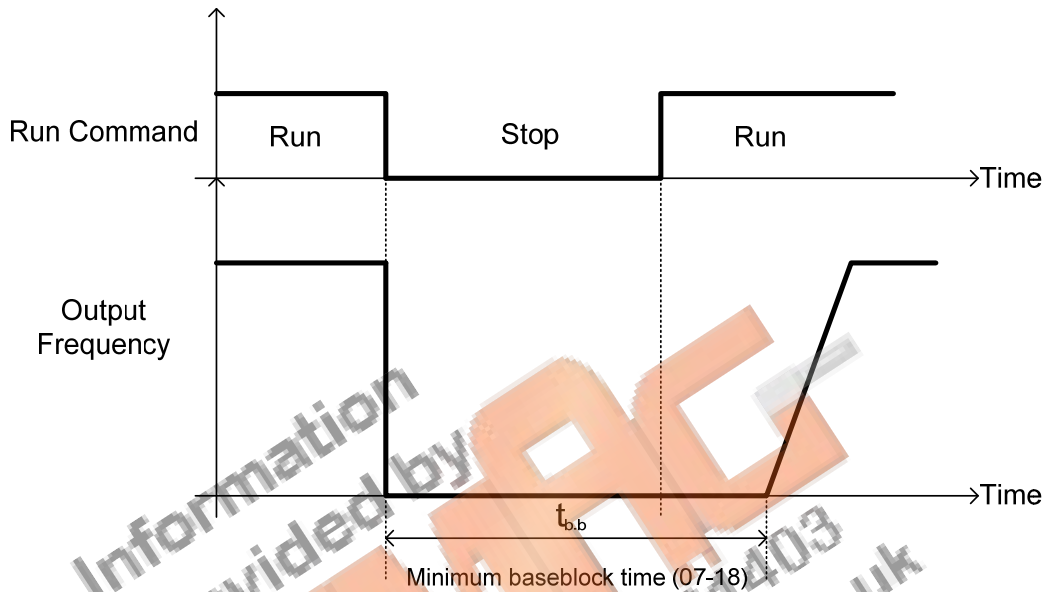

Figure 4.4.59 Coast to stop

07-09=1: DC braking to stop

When a stop command is issued, the inverter will turn off the output (Baseblock) and after the minimum Baseblock time (07-18) has expired activate DC braking (07-07). Refer to Figure 4.4.60.

The DC braking time (t_{DCDB}) of Figure 4.4.60 is determined by the value of 07-08 (DC Braking start time) and the output frequency at the time the stop command was issued.

$$t_{DCDB} = \frac{(07-08) \times 10 \times \text{output frequency}}{F_{max} (01-02)}$$

Note: Increase the minimum Baseblock time (07-18) in case an Overcurrent trip occurs during the DC braking.

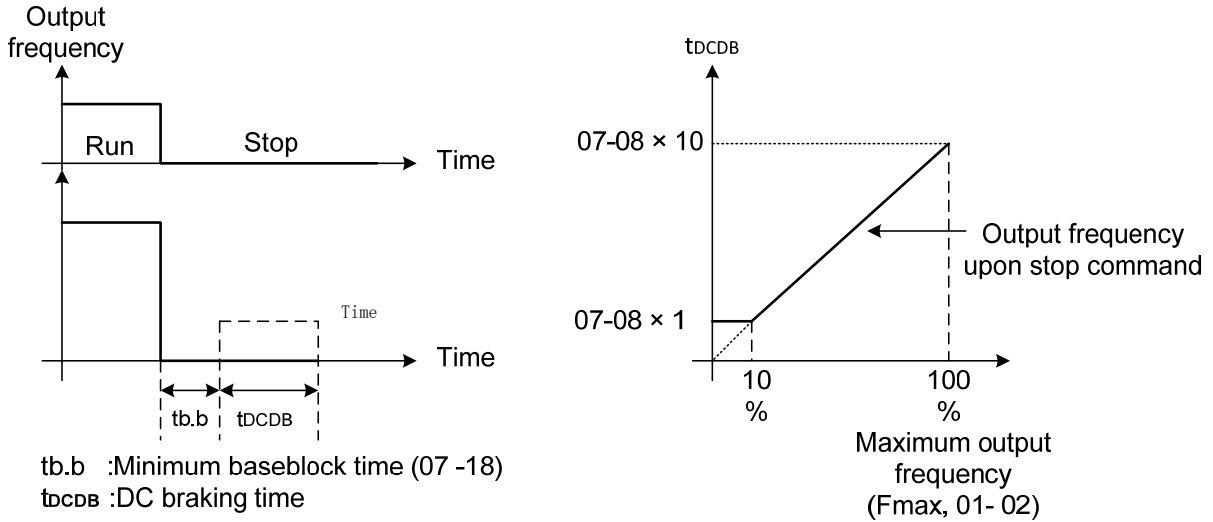

Figure 4.4.60 DC braking to stop

07-09=3: Coast to stop with timer

When a stop command is issued the motor will coast to a stop after the minimum Baseblock time (07-18) has expired. The inverter ignores the run command until the total time of the timer has expired.

The total time of the timer is determined by the deceleration time (00-15, 17, 22 or 24) and the output frequency upon stop. Refer to Figure 4.4.61

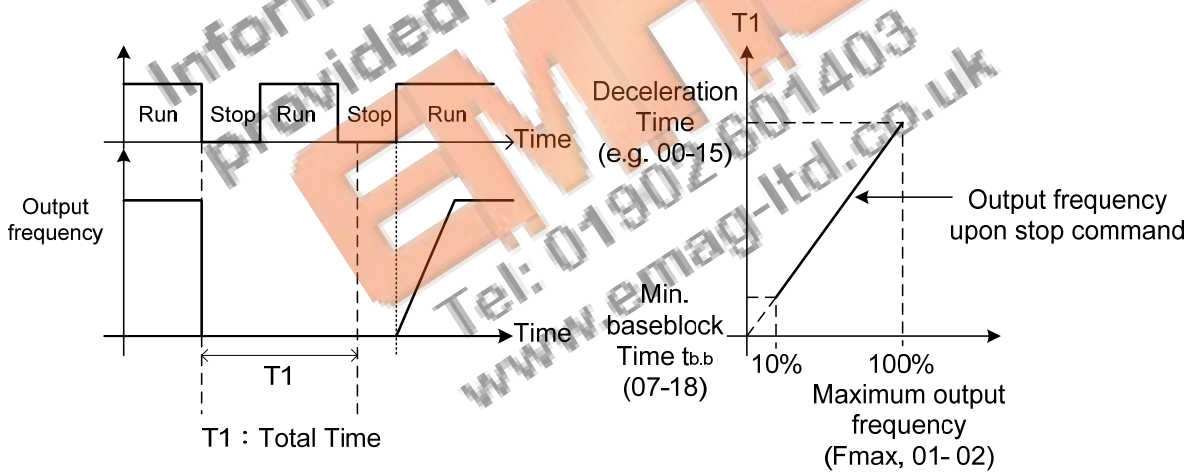

Figure 4.4.61 Coast to stop with timer

07-13	Low voltage detection level
Range	200V: 150~210Vdc 400V: 300~420Vdc

07-25	Low voltage detection time
Range	0.00~1.00 Sec

Adjust the 07-13 voltage level from 150 to 210 Vdc (200V class) or from 300 to 420 Vdc (400V class).

When the AC input voltage is lower than the 07-13 value (07-13/ 1.414 = AC voltage detection level) for the time specified in 07-25 the low-voltage error "UV" will displayed. If 07-25 = 0.00 sec., the UV error will be displayed immediately.

Set preventive measures:

- The inverter input voltage will limit the output voltage. If the input voltage drops excessively, or if the load is too big, the motor may stall.
- If the input voltage drops below the value set in 07-13 then the output is turned off momentarily. The inverter will not automatically start when power is restored.

07-14	Pre-excitation time
Range	0.00~10.00 Sec

07-15	Pre-excitation level
Range	50~200 %

If a high starting torque is required for the application, especially for a large horsepower motors, the pre-excitation operation can be used to pre-flux (magnetize) the motor.

Pre-excitation time (07-14)

When an operation command (forward or reverse) is activated, the inverter will automatically start pre-excitation based on the time set in parameter 07-14.

The time for the flux to reach 100% is a function value of motor's electrical time constant (See figure 4.4.62).

Electrical time constant (quadratic by-pass circuit time constant) can be calculated by motor parameter setting (group 02)

$$\text{Electrical time constant } T2 = \frac{\text{Motor leakage inductance (02-17) + motor mutual inductance (02-18)}}{\text{Motor rotor resistance (02-16)}}$$

Set the pre-excitation time (07-14) based on the electrical time constant T2

Pre-excitation initial level (07-15)

Use the pre-excitation initial level (07-15) to provide a higher excitation current during the pre-excitation time (07-14), which will increase the speed and stability for motors.

In order to quickly magnetize the motor, reduce the pre-excitation time (07-14) and set the pre-excitation level

(07-15) to a high level.

If 07-15 is set greater than 100%, providing a high excitation current during the pre-excitation time (07-14), motor's magnetization time is shorted. When the setting reaches 200%, magnetization is reduced by roughly half.

A high pre-excitation level (07-15) might result in excessive motor sound during pre-excitation.

When the flux reaches 100%, pre-excitation current reverts back to 100% and pre-excitation is completed.

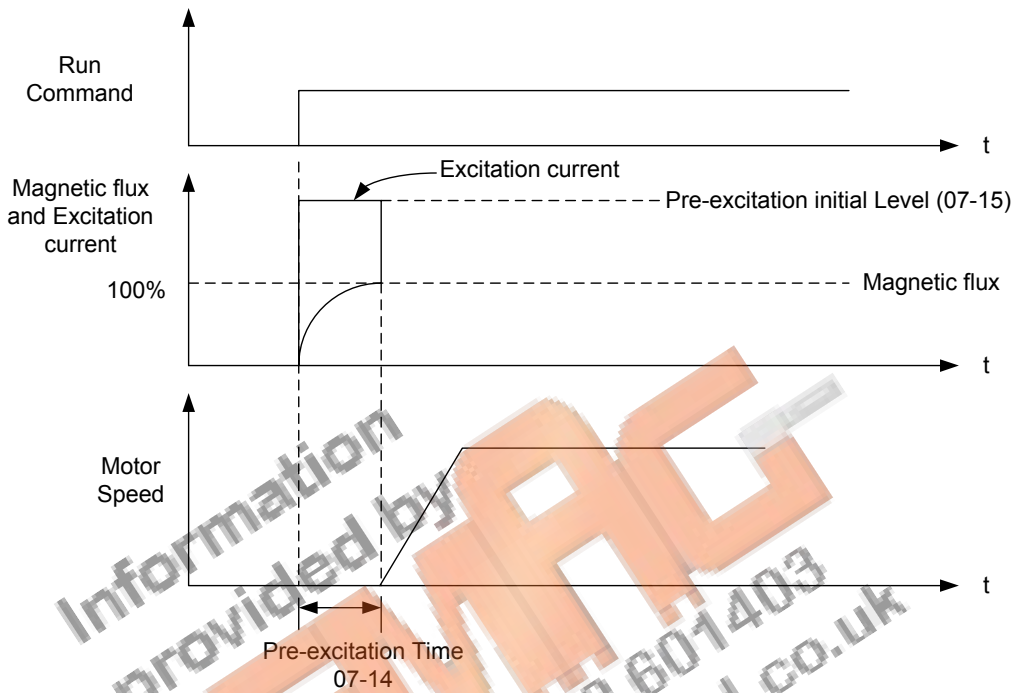

Figure 4.4.62 Pre-excitation operation

07-18	Minimum base block time
Range	0.1~5.0 Sec

In case of a momentary power failure, the inverter continues to operate after the power has been restored when parameter 07-00 is set to 1. Once the momentary power failure is detected; the inverter will automatically shut down the output and maintain B.B for a set time (07-18).

It is expected that after the minimum base block time has expired the residual voltage to be almost zero.

When the momentary power failure time exceeds the minimum base block time (07-18), the inverter will automatically perform a speed search upon return of power. Refer to the following figure 4.4.63.

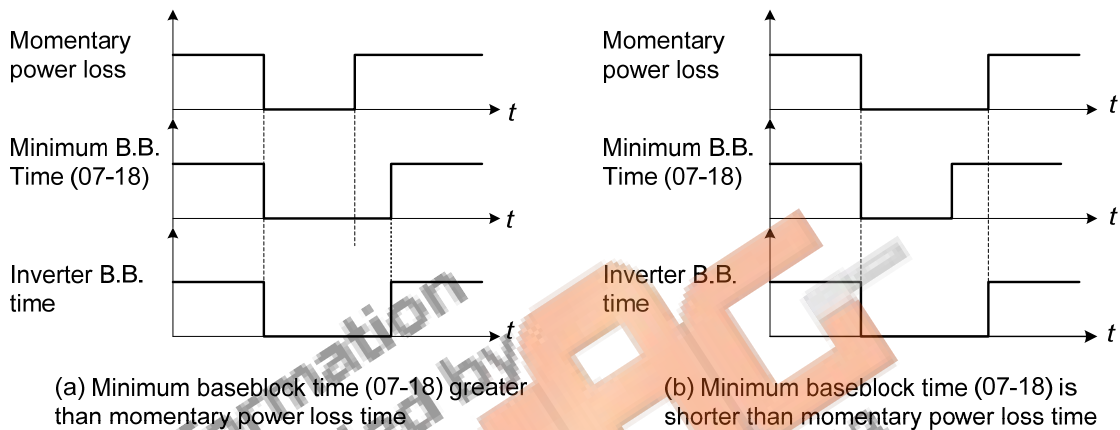

Figure 4.4.63 Minimum B.B. time and momentary power loss time

Minimum base block time (07-18) is also used to for the DC braking function in combination with speed search as follows:

- Set the minimum base block time required (07-18).
- Execute speed search or DC braking function.
- Increase minimum Baseblock time if over-current "OC" condition occurs.
- After speed search is completed, normal operation continues.

07-19	Speed Direction Search Operating Current
Range	0~100 %

07-20	Speed Search Operating Current
Range	0~100 %

07-21	Integral time of speed searching
Range	0.1~10.0 Sec

07-22	Delay time of speed searching
Range	0.0~20.0 Sec
07-23	Voltage recovery time
Range	0.1~5.0 Sec
07-24	Direction-Detection Speed Search Selection
Range	0: Disable 1: Enable
07-26	SLV Speed Search Function
Range	0: Enable 1: Disable
07-27	Start Selection after fault during SLV mode
Range	0: Start with speed search 1: Normal start
07-28	Start after external base block
Range	0: Start with speed search 1: Normal start

Speed search function is used to find the speed of a coasting motor and continue operation from that point. The speed search function is active after a momentary power loss. In V / F + PG or SV control mode (with PG control) speed search starts from the detected frequency (PG).

Speed Search from Multi-function digital inputs

Set the multi-function digital input to external speed search command 1 or 2. External speed search command 1 (value = 19) and 2 (value = 34) cannot be set at the same time, otherwise "SE02" (digital input terminal error) warning occurs.

Speed search function must be enabled before applying the run command to ensure proper operation. See relay logic in figure 4.4.64.

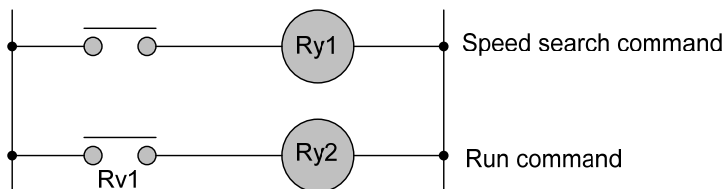

Figure 4.4.64 Speed search and operation commands

Notes: Speed Search Operation

- The speed search cannot be used when the motor rated power is greater than the inverter rated power.
- The speed search cannot be used when the motor rated power is two inverter sizes smaller than the inverter currently used.
- The speed search cannot be used in combination with a high-speed motor.
- In V / F mode, it is necessary to perform a static auto-tune.
- In SLV mode, it is necessary to perform a rotational auto-tune. Perform a static auto-tune when using long motor leads.

Speed search uses current detecting. Use parameter 07-24 to select detection direction.

07-19: Speed Direction Search Operating Current (07-19)

- Used in bidirectional speed search only (07-24 = 1).
 - Set bidirectional current level.
 - Increase value if speed search is not successful at low speeds (above 5Hz)
- Note:** If value is too high may cause DC braking effect.

07-20: Speed Search Operating Current (07-20)

- Can be used for bidirectional (07-24 = 1) or unidirectional (07-24 = 0) speed search.
- Sets speed search current Level.
- The set value must be lower than the excitation current (02-09) and must equal to the no-load current. If the no-load current is unknown it is recommended to set value at 20%.
- Excessive speed search current will cause inverter output to saturate.
- It is recommended to use speed search in case of a momentary power loss. Increase the minimum base block time (07-18) in case of an over-current condition.

07-21: Integral time of speed searching

- Can be used for bidirectional (07-24 = 1) or unidirectional (07-24 = 0) speed search.
- Set the integral time during speed search.
- If OV occurs, increase the set value to increase the speed search time. Decrease the value if a quick start is required

07-22: Delay time of speed searching

- Use delay time when using a contactor on the inverter output side.
- The inverter speed search starts after the delay time expires.
- Speed search delay time is disabled when set to 0.0 sec. (07-22 = 0.0)

07-23: Voltage recovery time

- Sets the voltage recovery time.
- Sets the time for the inverter to restore the output voltage from 0V to the specified V/f level after speed search function is completed.

07-24: Direction-Detection Speed Search Selection

0: Disable Direction-Detection Speed Search

Speed search is executed using speed search operating current defined in parameter 07-20. In case speed search is not successful (e.g. motor speed is too low) a speed search time-out warning is displayed. Set 07-19 to value greater than 0 to enable DC braking at speed search if a time-out occurs frequently.

1: Enable Direction-Detection Speed Search

At start the current controller will send a step current to the motor (07-19) to determine the motor direction. Once direction is determined the current controller will perform a speed search using speed search operating current defined in parameter 07-20. Speed search is executed after a momentary power loss (external speed search command 2, 03-00 to 03-07 = 34) or from max. frequency (external speed search command 1, 03-00 to 03-07 = 19). Speed search direction will follow the speed command.

07-26: SLV Speed Search Function

- In SLV mode (00-00 = 2) set the stop mode to the coast stop (07-09 = 1) or to the coast to stop with timer (07-09 = 3). After a stop command is issued (coast to stop or coast to stop with times) the speed search function is automatically activated for the next start.

0: Enable (No mechanical brake is installed)

1: Disable (Mechanical brake is installed)

07-27: Start Selection after fault during SLV mode

0: Speed search start: Speed search is executed after a fault in SLV mode.

1: Normal start: Speed search is not enabled.

Note: Set the parameter to 1 (normal start) after a fault has occurred and a mechanical brake is used to stop the motor.

07-28: Start after external Baseblock

0: Speed search start: Speed search is executed after base block is removed.

1: Normal start: Speed search is not enabled.

Note: Set parameter to 1 for control mode is V/F (00-00 = 0) or SLV mode (00-00 = 2) when the external base block active time is longer than the time the motor needs to come to a complete stop. After the external base block command is removed the inverter will accelerate from min. frequency.

■ Speed search based on current detection

(a) Speed search at starting

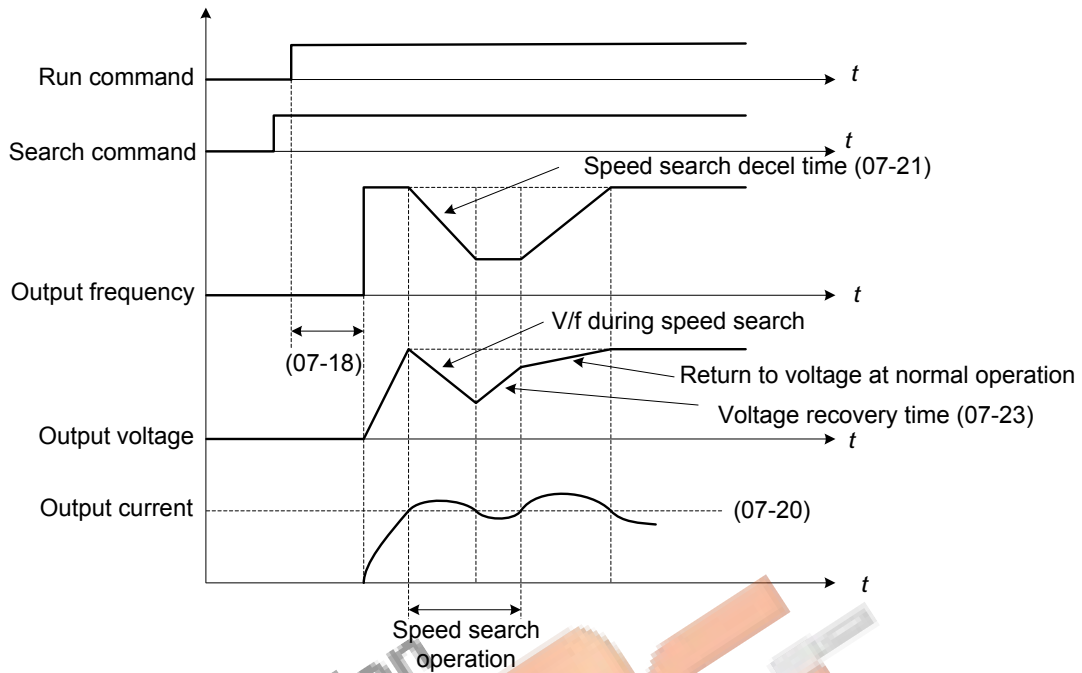

Figure 4.4.65 Speed search at starting

(b) Speed search in recovery period of momentary power failure

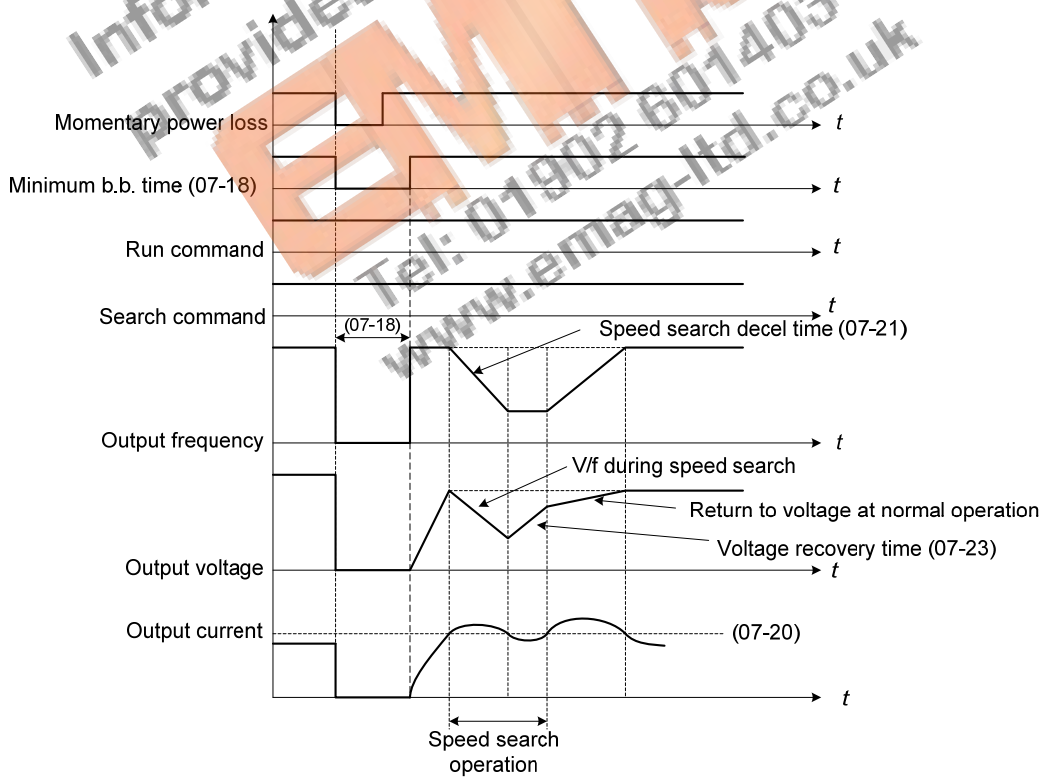

Figure 4.4.66 Speed search in recovery period of momentary power failure

Notes:

If the minimum base block time (07-18) is longer than the momentary power failure time, the speed search starts operation after the minimum base block time (07-18).

If the minimum base block time (07-18) is too short, the speed search operation begins immediately after power has been restored.

08-Protection Parameters	
08-00	Stall prevention function.
Range	xxx0b: Stall prevention function is enabled during acceleration. xxx1b: Stall prevention function is disabled during acceleration. xx0xb: Stall prevention function is enabled during deceleration. xx1xb: Stall prevention function is disabled during deceleration. x0xxb: Stall prevention function is enabled during operation. x1xxb: Stall prevention function is disabled during run. 0xxxb: Stall prevention function during run is based on the first acceleration time. 1xxxb: Stall prevention function during run is based on the second acceleration time.
08-01	Stall prevention level during acceleration
Range	30~200 %
08-02	Stall prevention level during deceleration
Range	330~410V : 230V 660~820V : 460V
08-03	Stall prevention level during run
Range	30~200 %
08-21	Limit of stall prevention during acceleration
Range	0~100 %
08-22	Stall prevention detection time during run
Range	2~100 msec

Stall prevention during acceleration (08-00=xxx0b)

Prevents the inverter from faulting (Overcurrent, Motor overload, Inverter overload) when accelerating with heavy loads.

When the inverter output current reaches the level set in parameter 08-01 minus 15% the acceleration rate starts to decrease. When the inverter output current reaches the level set in parameter 08-01 the motor stops accelerating. Refer to figure 4.4.67 for more information.

Notes:

- Reduce stall prevention level during acceleration (08-01) in case the motor stalls (when the motor power is smaller than the inverter rating).
- The inverter rated output current should be set to 100%.

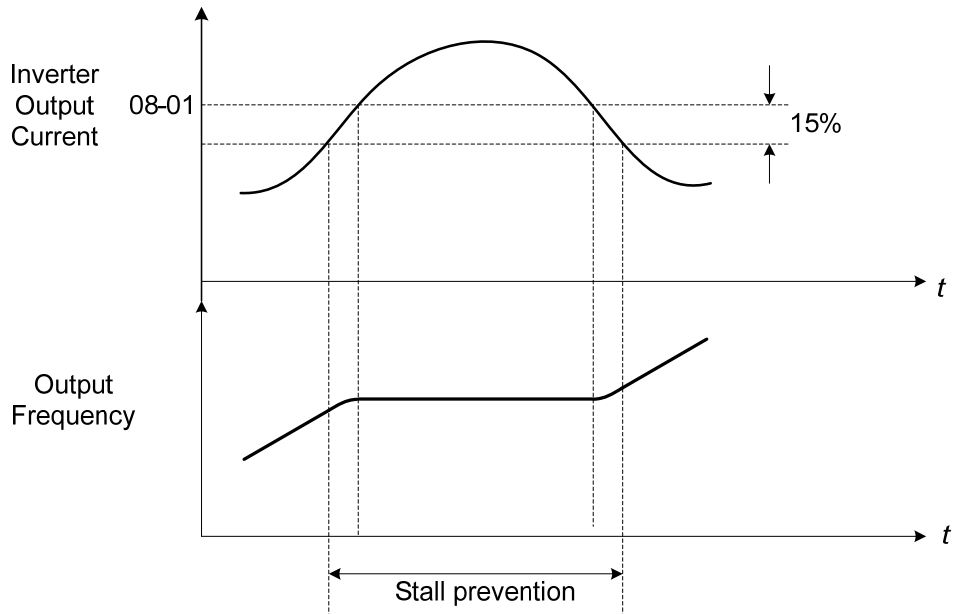

Figure 4.4.67 Stall prevention during acceleration

If the motor is used in the constant power (CH) region, the stall prevention level (08-01) is automatically reduced to prevent the stall.

Stall prevention level during acceleration (Constant horsepower)

$$\text{Stall Prev. Lev. Acceleration (CH)} = \frac{\text{Stall prevention level in acceleration (08-01)} \times \text{Fbase (01-12)}}{\text{Output frequency}}$$

Parameter 08-21 is the stall prevention limit value in Constant Horsepower region. Refer to figure 4.4.68.

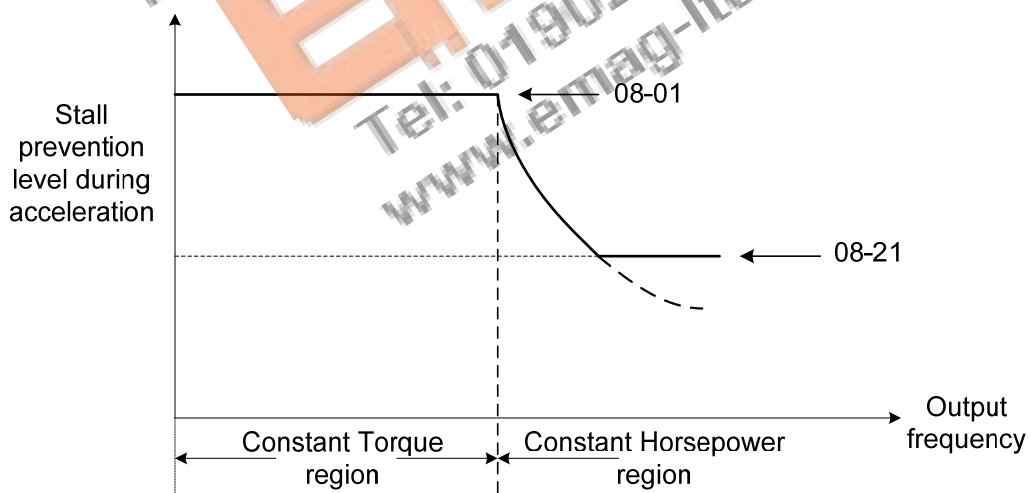

Figure 4.4.68 Stall prevention level and limit in acceleration

Stall prevention selection during deceleration (08-00=xx0xb)

Stall prevention during deceleration automatically increases the deceleration time according based on the DC-bus voltage to prevent over-voltage during deceleration. Refer to Figure 4.4.69 for stall prevention during deceleration

When the DC-bus voltage exceeds the stall prevention level deceleration will stop and the inverter will wait for the DC-bus voltage to fall below the stall prevention level before continuing deceleration. Stall prevention level can be set by 08-02, see Table 4.4.13.

Table 4.4.13 Stall prevention level

Inverter model	08-02 default value
200V class, 1 to 10HP	395VDC
200V class, 15HP and above	385VDC
400V class, 01-14<400V	680VDC
400V class, 1 to 15HP and above	790VDC
400V class, 20HP and above	770VDC

Note: When using external braking (braking resistor or braking module) disable stall prevention during deceleration (08-00 to xx1xb).

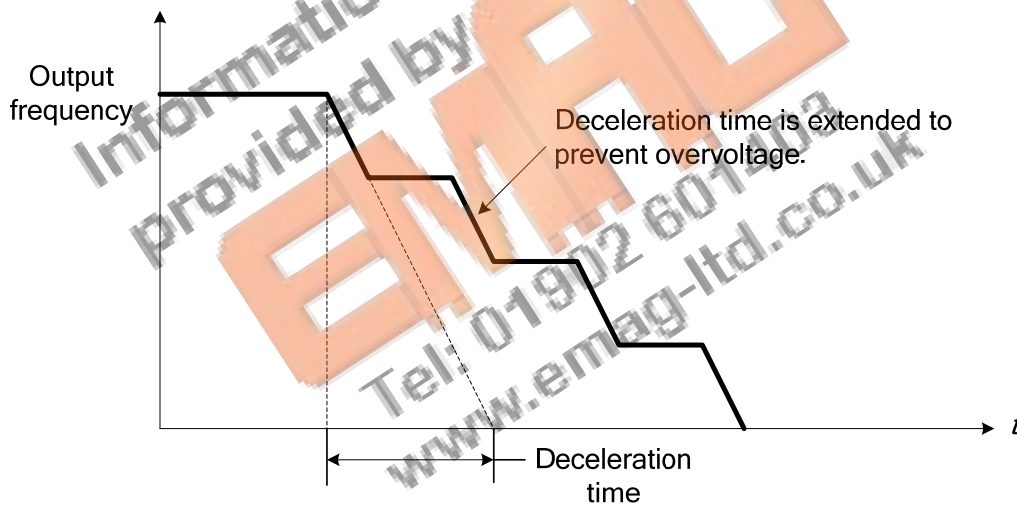

Figure 4.4.69 Stall prevention selection in deceleration

Stall prevention selection during run (08-00=x0xxb)

Stall prevention during run can only be used in V/F or V/F + PG control mode.

This function prevents the motor from stalling by automatically reducing the output frequency during run.

If the inverter output current rises above the level set in parameter 08-03 for the time specified in parameter 08-22, the inverter output frequency is automatically decreased following deceleration time 1 (00-15) or deceleration time 2 (00-17).

When the inverter output current falls below the level set in parameter (08-03) minus 2%, normal operation continues and the output frequency increases to the frequency reference using the acceleration time 1 or acceleration time 2. Refer to the following figure 4.4.70.

Note: The stall prevention level during run can be set by using multi-function analog input AI2 (04-05=7).

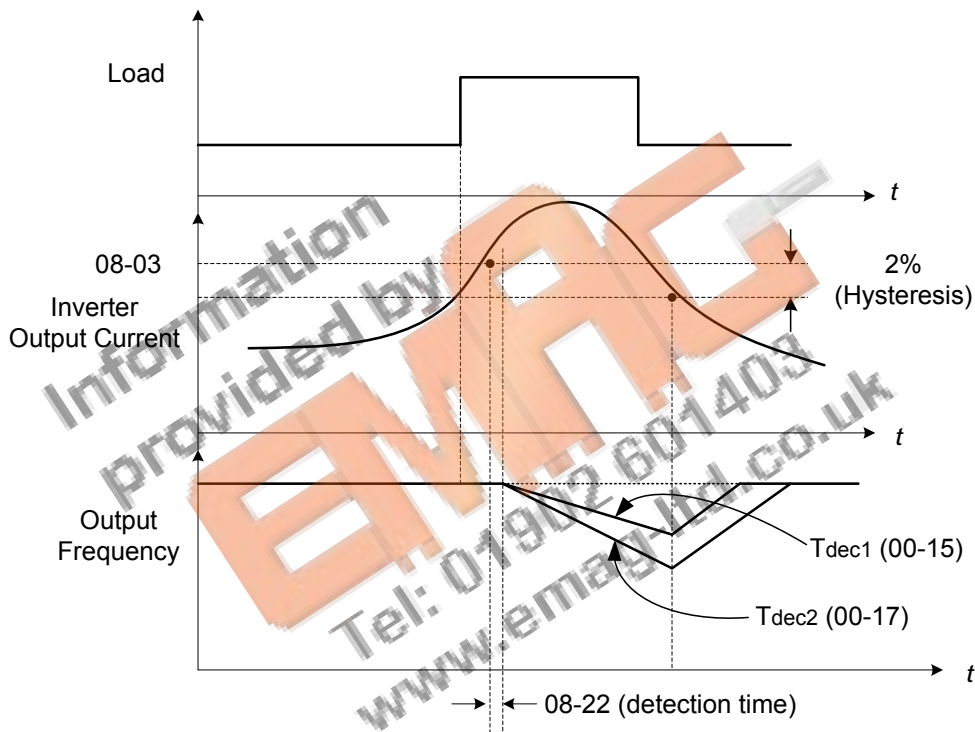

Figure 4.4.70 Stall prevention selection in operation

08-05	Selection for motor overload protection (OL1)
Range	xxx0b : Motor overload is disabled xxx1b : Motor overload is enabled xx0xb : Cold start of motor overload xx1xb : Hot start of motor overload x0xxb : Standard motor x1xxb : Special motor 0xxxb : Reserved 1xxxb : Reserved

The motor overload protection function estimates the motor overload level based on the output current, output frequency, motor characteristics and time. The motor overload trip time depends on the motor rated current when the output frequency is greater than 60Hz.

On inverter power-up the motor overload protection internal thermal accumulation register is automatically reset.

To use the built-in motor overload protection function parameter 02-01 (motor rated current) has to match the motor rated current on the motor nameplate.

Turn off the motor overload protection when using two or more motors connected to the inverter (set 08-05 = xxx0b), and provide external overload protection for each motor (e.g. thermal overload switch).

With cold start enabled (08-05 = xx0xb), motor overload protection occurs in 5 and a half minutes when operating the motor at 150% of the motor rated current at an output frequency greater than 60Hz.

With hot start enabled (08-05 = xx1xb), motor overload protection occurs in 3 and a half minutes when operating the motor at 150% of the motor rated current at an output frequency greater than 60Hz.

Refer to the following figure 4.4.71 for an example of motor overload protection standard curve.

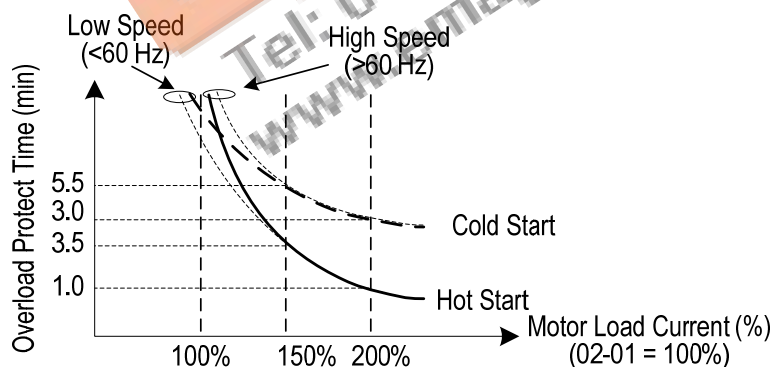

Figure 4.4.71 Motor overload protection curve (example: standard motor)

When using force cooled motors (Special inverter motor), thermal characteristics are independent of the motor speed, set 08-05 = x1xxb.

When 08-05 = x1xxb, overload protection function is based on motor rated current for output frequencies between 6 and 60Hz. If the output frequency is lower than 1Hz, the overload protection function uses 83% of the motor rated current to determine an overload condition.

When 08-05 = x0xxb, overload protection function is based on 70% of the motor rated current for an output frequency of 20Hz. If the output frequency is lower than 1Hz, the overload protection function uses 40% of the motor rated current to determine an overload condition.

Figure 4.4.72 shows motor overload rating at different output frequencies.

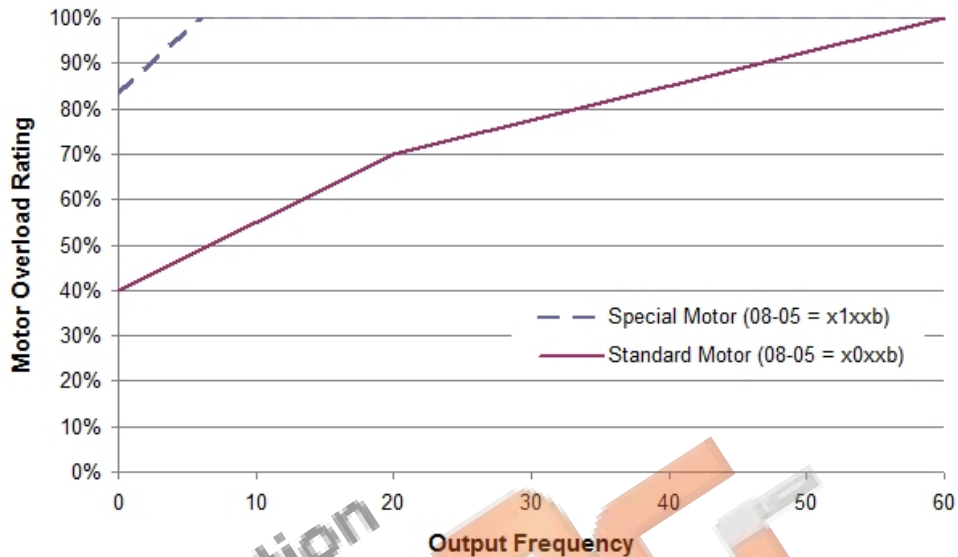

Figure 4.4.72 Motor overload rating at different output frequencies

08-06	Start-up mode of overload protection operation (OL1)
Range	0: Stop output after overload protection 1: Continuous operation after overload protection.

08-06=0: When the inverter detects a motor overload the inverter output is turned off and the OL1 fault message will flash on the keypad. Press RESET button on the keypad or activate the reset function through the multi-function inputs to reset the OL1 fault.

08-06=1: When the inverter detects a motor overload the inverter will continue running and the OL1 alarm message will flash on the keypad until the motor current falls within the normal operating range.

08-08	Automatic voltage regulation (AVR)
Range	0: AVR is enabled 1: AVR is disabled

Automatic voltage regulation stabilizes the motor voltage independent of fluctuation to the input voltage.

08-08=0: Automatic voltage regulation is active.

08-08=1: Automatic voltage regulation is not active, motor voltage follows the input voltage fluctuation.

08-09	Selection of input phase loss protection
Range	0: Disable 1: Enable

08-09=0: Input phase loss detection is disabled.

08-09=1: Input phase loss detection is enabled. Keypad shows "IPL input Phase Loss" (IPL), when an input phase loss is detected the inverter output is turned off and the fault contact is activated.

Note: The input phase loss detection is disabled when the output current is less than 30% of the inverter rated current.

08-10	Selection of output phase loss protection
Range	0: Disable 1: Enable

08-10=0: Output phase loss detection is disabled.

08-10=1: Output phase loss detection is enabled. Keypad shows "OPL Output Phase Loss" (OPL), when an output phase loss is detected and the inverter output is turned off and the fault contact is activated.

Note: The output phase loss detection is disabled when the output current is less than 10% of the inverter rated current.

08-13	Selection of over-torque detection
Range	0: Over-torque detection is disabled 1: Start to detect when reaching the set frequency 2: Start to detect when the operation is begun

08-14	Selection of over-torque action
Range	0: Deceleration to stop when over-torque is detected. 1: Displays warning when over-torque is detected. Continue operation. 2: Coast to stop when over-torque is detected

08-15	Level of over-torque detection
Range	0~300 %

08-16	Time of over-torque detection
Range	0.0~10.0 Sec

08-17	Selection of low-torque detection
Range	0: Low-torque detection is disabled 1: Start to detect when reaching the set frequency 2: Start to detect when the operation is begun

08-18	Selection of low-torque action
Range	0: Deceleration to stop when low-torque is detected 1: Display warning when low-torque is detected. Go on operation 2: Coast to stop when under-torque is detected

08-19	Level of low-torque detection
Range	0~300%

08-20	Time of low-torque detection
Range	0.0~10.0 Sec

The over torque detection function monitor the inverter output current or motor torque and can be used to detect increase in inverter current or motor torque (e.g. heavy load).

The low torque detection function monitor the inverter output current or motor torque and can be used to detect a decrease in inverter current or motor torque (e.g. belt break).

The torque detection levels (08-15, 08-19) are based on the inverter rated output current (100% = inverter rated output current) when operating the inverter in V/F control or V/F control + PG and motor output torque (100% = motor rated torque) when operating the inverter in SLV or SV control.

Over-torque detection

Parameter 08-13 selects over-torque detection function. An over-torque condition is detected when the output current / torque rises above the level set in parameter 08-15 (Over-torque detection level) for the time specified in parameter 08-06 (Over-torque detection time).

08-13=0: Over-torque detection is disabled.

08-13=1: Over-torque detection is enabled when the output frequency reaches the set frequency.

08-13=2: Over-torque detection is enabled during running.

Parameter 08-14 selects the way the inverter acts when an over-torque condition is detected.

08-14=0: When an over-torque condition is detected the inverter displays an over-torque detection fault and the motor decelerates to a stop.

08-14=1: When an over-torque condition is detected the inverter displays an over-torque detection alarm and continues to run.

08-14=2: When an over-torque condition is detected the inverter displays an over-torque detection fault and the motor coasts to a stop.

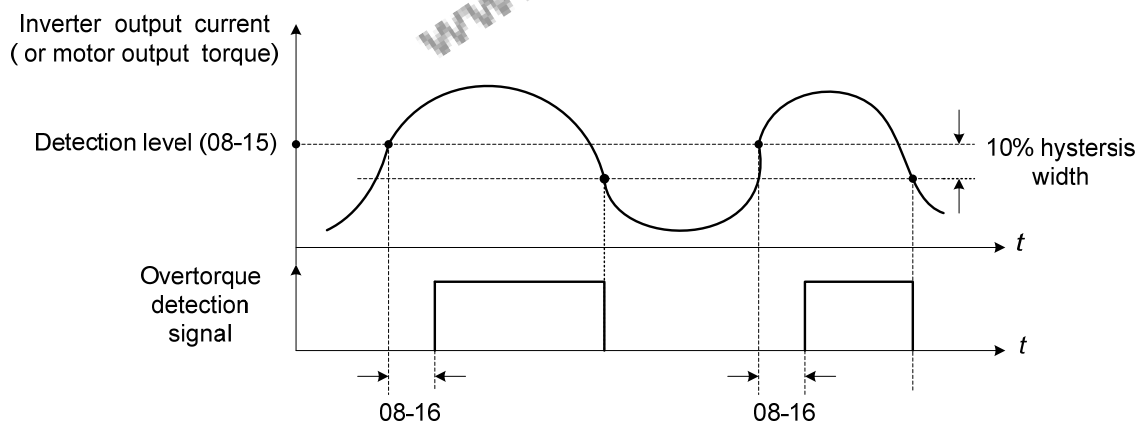

Figure 4.4.73 Over-torque detection operation

Low-torque detection

Parameter 08-18 selects low-torque detection function. An low-torque condition is detected when the output current / torque falls below the level set in parameter 08-19 (low-torque detection level) for the time specified in parameter 08-20 (Low-torque detection time).

08-17=0: Low-torque detection is disabled.

08-17=1: Low-torque detection is enabled when the output frequency reaches the set frequency.

08-17=2: Low-torque detection is enabled during running.

Parameter 08-18 selects the way the inverter acts when an over-torque condition is detected.

08-18=0: When a low-torque condition is detected the inverter displays and low-torque detection fault and the motor decelerates to a stop.

08-18=1: When a low-torque condition is detected the inverter displays a low-torque detection alarm and continues to run.

08-18=2: When a low-torque condition is detected the inverter displays and low-torque detection fault and the motor coasts to a stop

. Setting Example of less torque detection:

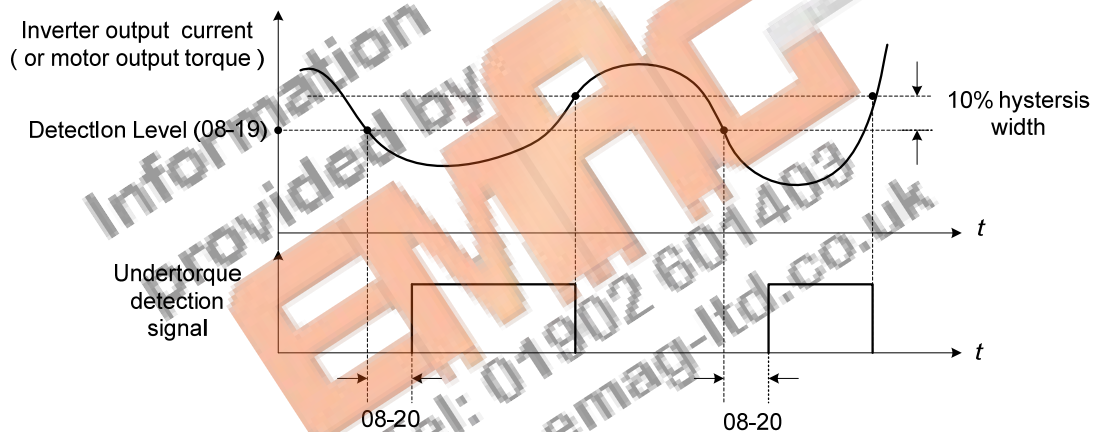

Figure 4.4.74 Low torque detection operation

Over and low torque detection condition can be output to the multi-function digital outputs (R1A-R1C, R2A-R2C) by setting parameters 03-11 to 03-12 to 12 or 25. Refer to figure 4.4.75 for more information.

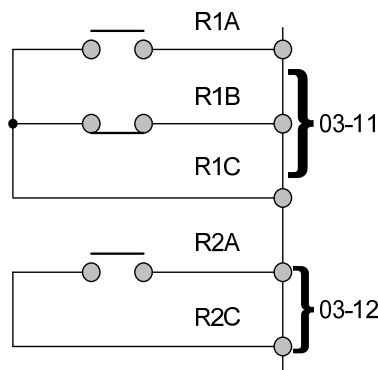

Figure 4.4.75 Over-torque / low torque detection multi-function digital output terminal

08-23	Ground Fault (GF) selection
Range	0: Disable 1: Enable

If the inverter leakage current is greater than 50% of inverter rated current and the ground fault function is enabled (08-23), the keypad will display a "GF Ground Fault" (GF), motor will coast to a stop and fault contact is activated.

08-24	External Fault Operation Selection
Range	0: Deceleration to stop 1: Coast to stop 2: Continue operation

Select operation selection when an external fault occurs. Refer to the multi-function inputs on how to set up the inverter for an external fault input.

08-25	Detection selection of external fault
Range	0: Immediately detect when the power is supplied 1: Start to detect during operation

Information
provided by
EMAG
Tel: 01902 601403
www.emag-ltd.co.uk

09-Communication Parameters

09-00	INV Communication Station Address
Range	1~31
09-02	Baud rate setting (bps)
Range	0: 1200 1: 2400 2: 4800 3: 9600 4: 19200 5: 38400
09-03	Stop bit selection
Range	0: 1 stop bit 1: 2 stop bits
09-04	Parity selection
Range	0: No Parity 1: Even bit 2: Odd bit
09-06	Communication error detection time
Range	0.0~25.5 Sec
09-07	Fault stop selection
Range	0: Deceleration to stop based on deceleration time 1. 1: Coast to stop when communication fault occurs. 2: Deceleration to stop based on deceleration time 2. 3: Keep operating when communication fault occurs.
09-08	Comm. fault tolerance count
Range	1~20
09-09	Waiting time
Range	5~65 msec

The Modbus communication port RJ45 (S+, S-) can be used to monitor, control, program and trouble-shoot the inverter.

Modbus communication can perform the following operations, independent of the frequency command selection (00-05) setting and Operation command selection (00-02) setting:

- Monitor inverter signals
- Read and write parameters.
- Reset fault
- Control multi-function inputs

Modbus (RS-485) communication specification:

Items	Specification
Interface	RS-485
Communication type	Asynchronous (start - stop synchronization)
Communication parameters	Baud rate: 1200, 2400, 4800, 9600, 19200 and 38400 bps Data Length: 8 bits (Fixed) Parity: options of none, even and odd bit. For even and odd selection stop bit is fixed at 1 bit.
Communication protocol	Modbus RTU / ASCII
Number of inverters	Maximum 31 units

Communication wiring and setup

- (1) Turn off power to the inverter.
- (2) Connect communication lines of the controller to the inverter (RJ45).
- (3) Turn power on.
- (4) Set the required communication parameters (09-00) via the keypad.
- (5) Turn off power to the inverter and wait until keypad is completely off.
- (6) Turn power on
- (7) Start communication between controller and inverter.

Modbus (485) communication architecture

- (1) Modbus communication configuration uses a master controller (PC, PLC), communicating to a maximum of 31 inverters.
- (2) The master controller is directly connected to the inverter via the RS-485 interface. If the master controller has a RS-232, a converter must be installed to convert signals to RS-485 to connect the master controller to the inverter.
- (3) A maximum 31 inverters can be connected to a network, following the Modbus communication standard.

Communication Parameters:

09-00: Inverter station addresses: Range 1-31

09-02: RS-485 communication baud rate setting

- = 0: 1200 bps (bits / second)
- = 1: 2400 bps
- = 2: 4800 bps
- = 3: 9600 bps
- = 4: 19200 bps
- = 5: 38400 bps

09-03: Stop bit selection

- = 0: 1 stop bit
- = 1: 2 stop bits

09-04: Parity selection of RS-485 communication

- = 0: No parity.
- = 1: even parity.
- = 2: odd parity.

09-06: RS-485 communication error detection time

09-07: Stop selection of RS-485 communication failure

= 1: Deceleration to stop by deceleration time 00-15

= 2: Coast to stop

= 2: Deceleration to stop using the deceleration time of 00-26 (emergency stop time)

= 3: Continue to operate (only shows a warning message, press the stop button to stop operation)

09-08: Comm. fault tolerance count

When the number of communication errors exceeds the value set in parameter 09-08 the inverter will display the comm. Fault alarm.

09-09: Wait time of inverter transmission (09-09).

Sets the inverter response delay time. This is the time between the controller message and the start of the inverter response message. Refer to figure 4.4.76. Set the controller receive time-out to a greater value than the wait time parameter (09-09).

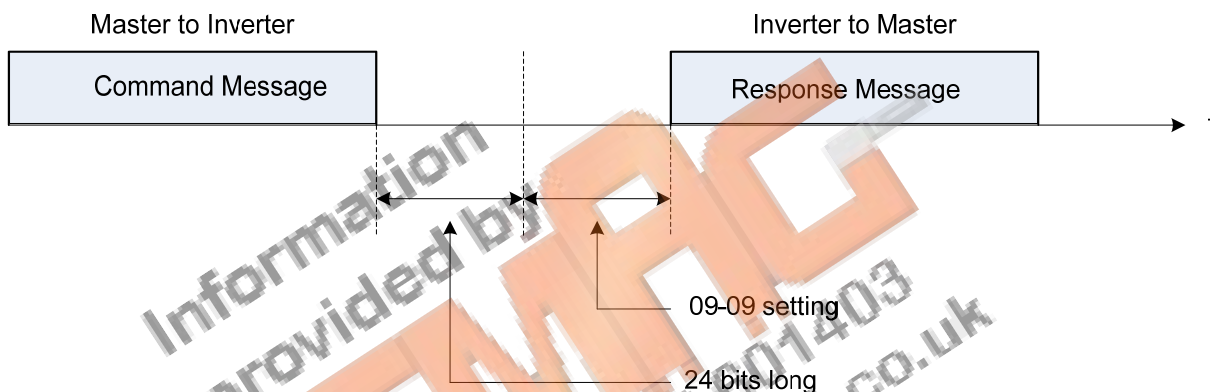

Figure 4.4.76 Communication Message Timing

10-PID Parameters

10-00	PID target value source setting
Range	1: AI1 given 2: AI2 given 3: Reserved 4: Use 10-02 setting

Note: Parameter only active when frequency command selection (00-05) is set to 5.

10-01	PID feedback value source setting
Range	1: AI1 given 2: AI2 given 3: Reserved

Note: Parameter 10-00 and 10-01 cannot be set to the same source. If both parameters are set to the same source the keypad will show a SE05 alarm.

10-02	PID target value
Range	0.0~100.0 %

10-03	PID control mode
Range	xxx0b: PID disabled xxx1b: PID enabled xx0xb: PID positive characteristic xx1xb: PID negative characteristic x0xxb: PID error value of D control x1xxb: PID feedback value of D control 0xxxb: PID output 1xxxb: PID output +target value

10-04	Feedback gain
Range	0.01~10.00

10-05	Proportional gain (P)
Range	0.00~10.00

10-06	Integral time (I)
Range	0.0~100.0 Sec

10-07	Differential time (D)
Range	0.00~10.00 Sec

10-09	PID bias
Range	-100~100 %

10-10	PID Primary delay time
Range	0.00~10.00 %

10-14	PID integral limit
Range	0.0~100.0 %

10-23	PID limit
Range	0.00~100.0 %

10-24	PID output gain
Range	0.0~25.0

10-25	PID reversal output selection
Range	0: Do not allow the reversal output 1: Allow the reversal output

10-26	PID target acceleration / deceleration time
Range	0.0~25.5 Sec

PID Adjustments

Gain control: The error signal (deviation) between the input command (set value) and the actual control value (feedback). This error signal or deviation is amplified by the proportional gain (P) to control the offset between the set value and the feedback value.

Integral control: The output of this control is the integral of the error signal (difference between set value and feedback value) and is used to minimize the offset signal that is left over from the gain control. When the integral time (I) is increased, the system response becomes slower.

Differential control: This control is the inverse from integral control and tries to guess the behavior of the error signal by multiplying the error with the differential time. The result is added to the PID input. Differential control slows down the PID controller response and may reduce system oscillation. **Note:** Most applications that PID control (fan and pump) do not require differential control. Refer to Figure 4.4.77 for PID control operation

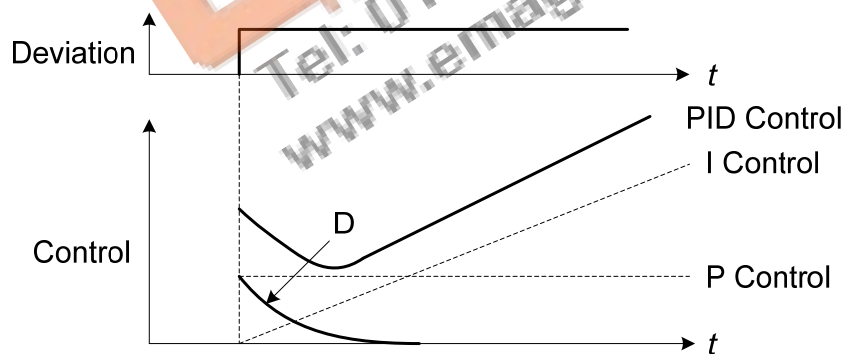

Figure 4.4.77 PID Control

PID Control Type

The inverter offers two types of PID control:

(a) **PID control with differential feedback:** (10-03 = x1xxb)

Make sure to adjust the PID parameters without causing system instability. Refer to Figure 4.4.78 for PID control for feedback value differential.

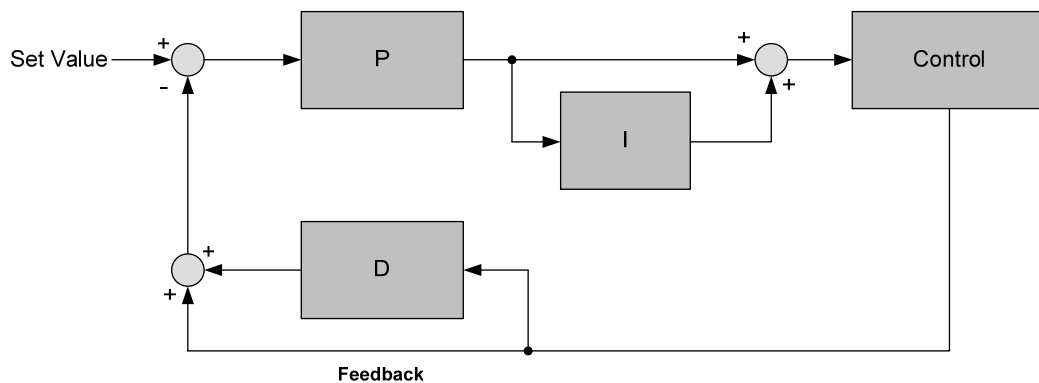

Figure 4.4.78 PID control for feedback differential value

(b) Basic PID control: (10-03 = x0xxb)

This is the basic type of PID control. Refer to the figure 4.4.79.

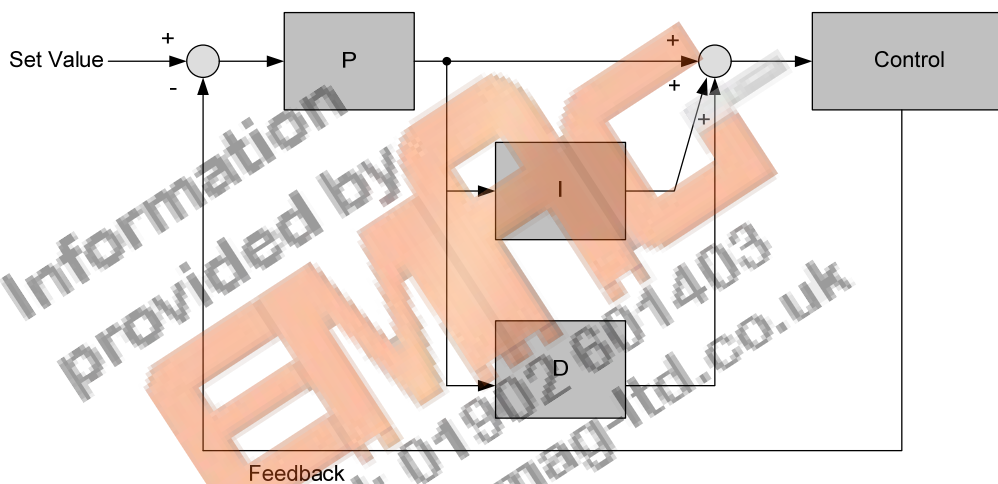

Figure 4.4.79 Basic PID control

PID Setup

Enable PID control by setting parameter 10-03, PID target value (10-00) and PID feedback value (10-01).

To use PID control set frequency command selection 00-05 to 4.

- (1) Select PID target value (10-00):

10-00: PID target value

- =1: analog AI1 given (default)
- =2: analog AI2 given
- =3: Reserved
- =4:10-02

- (2) Select PID feedback value (10-01):

10-01: PID feedback value

- = 1: Analog AI1 given
- = 2: Analog AI2 given
- = 3: Reserved

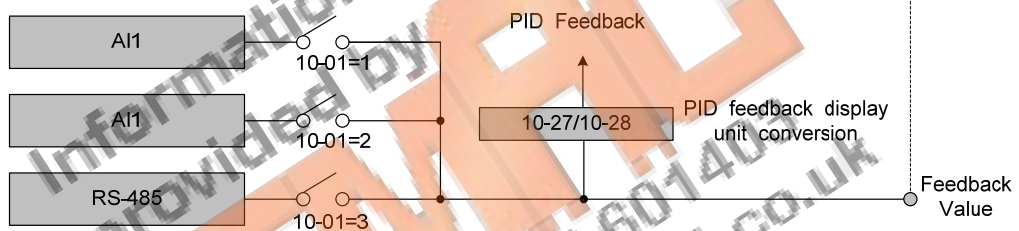
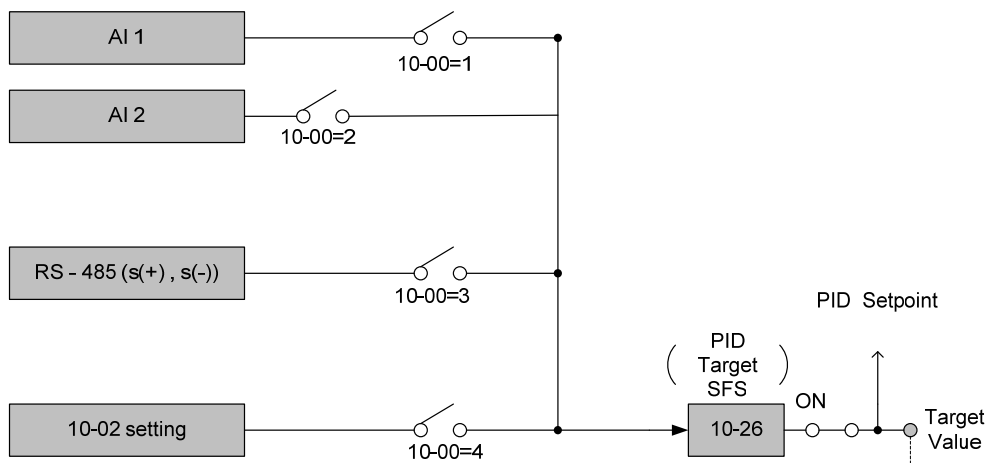

Figure 4.4.80 PID input selection

PID Control Setting

PID control block diagram.

The following figure shows the PID control block diagram.

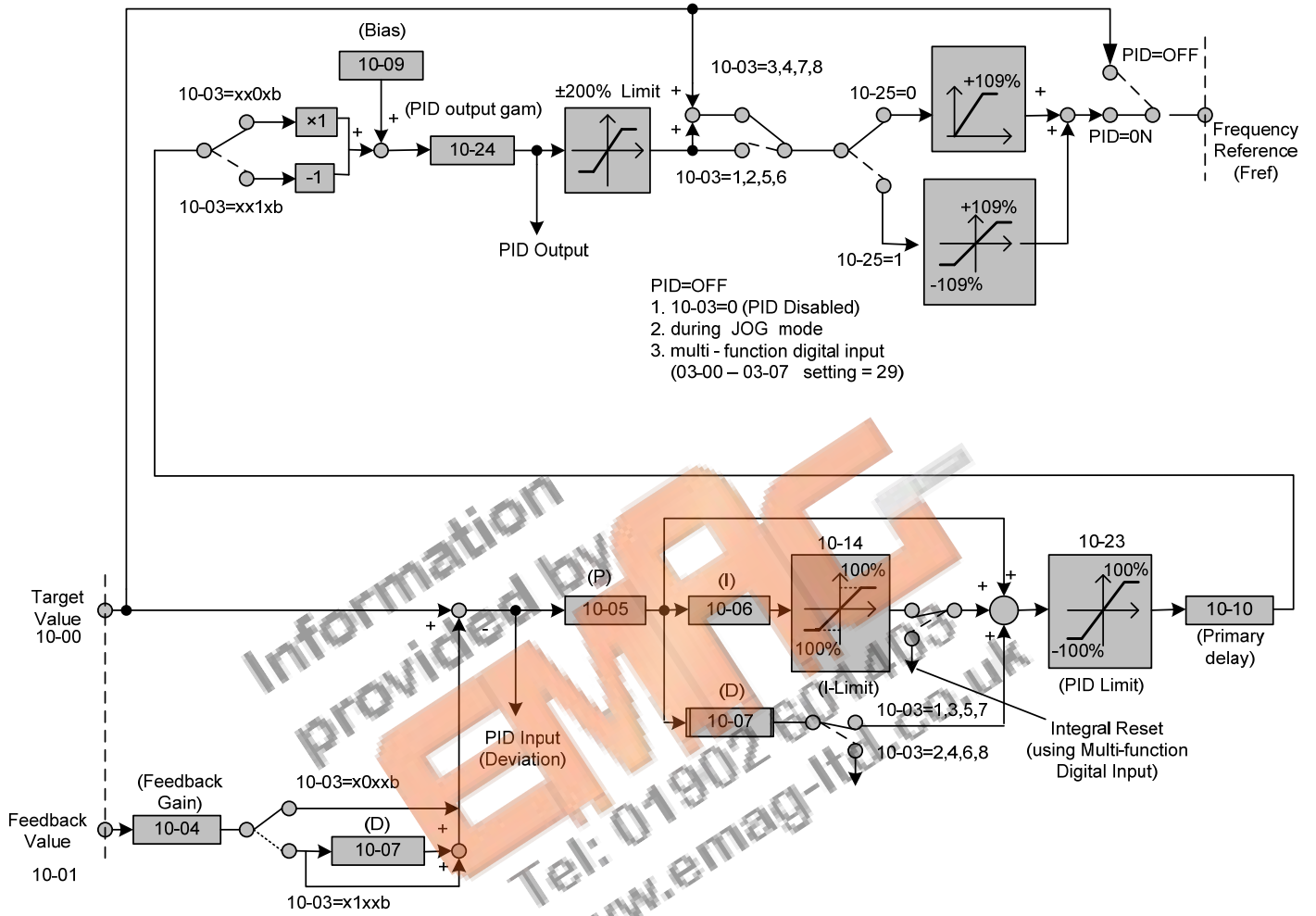

Figure 4.4.81 PID control block diagram

PID Tuning

Use the following procedures to start PID control,

- (1) Enable PID control (set 10-03 to a value greater than "xx0b").
- (2) Increase the proportional gain (10-05) to the highest value possible without causing the system to become unstable.
- (3) Decrease the integral time (10-06) to the lowest value possible without causing the system to become unstable.
- (4) Increase the differential time (10-07) to the highest value possible without causing the system to become unstable.

The PID control serves to maintain a given process within certain limits whether it is pressure, flow etc. To do this the **feedback** signal is compared to the **set value** and the difference becomes the error signal for the PID control.

The PID control then responds by trying to minimize this error. The error is multiplied times the value of the **Proportional gain** set by parameter **10-05**. An increased gain value results in a larger error. However, in any system as the gain is increased there is a point that the system will become unstable (oscillate).

To correct this instability, the response time of the system may be **slowed** down by increasing the **Integral time** set by parameter **10-06**. However slowing the system down too much may be unsatisfactory for the process.

The end result is that these two parameters in conjunction with the acceleration time (01-14) and deceleration (**01-15**) times require to be adjusted to achieve optimum performance for a particular application.

PID output polarity can be selected with parameter 10-03 (setting = xx0xb: PID output forward, setting = xx1xb: PID output reversal). When the PID output is set for reverse operation the output frequency decreased when the PID target value increases.

PID feedback value can be adjusted using parameter 10-04 (PID feedback gain) as well as with the analog input gain and bias for terminal AI1 or AI2.

10-14: PID integral limit: Used to limit the integral output to prevent motor stall or damage to the system in case of a rapid change in the feedback signal. Reduce the value of 10-14 to increase the inverter response.

10-23: PID limit: Used to limit the output of the PID control. Maximum output frequency is 100%.

10-10: Primary delay time: Low pass filter situated after the PID limit block that can be used to prevent PID output resonance. Increase the time constant to a value greater than the resonance frequency cycle and reduce time constant to increase the inverter response.

10-09: PID bias: Used to adjust the offset of the PID control. The offset value is added to the frequency reference as compensation. Use parameter 10-24 (PID output gain) to control the amount of compensation.

In case the PID control output value goes negative, parameter 10-25 (PID reversal output selection) can be used to reverse the motor direction.

Note: The PID output remains at zero when reverse operation is disabled.

10-26: PID target SFS: Sets the PID target value acceleration and deceleration ramp time. The PID target SFS can be disabled by setting the multi-function digital inputs 03-00 ~ 03-07 to 36 (PID target SFS is off). Reduce the acceleration / deceleration time in case load resonance or system instability is encountered.

PID Fine Tuning

All PID control parameters are related to each other and require to be adjusted to the appropriate values. Therefore, the procedure achieving the minimum steady-state is shown as following:

- (1) Increase or decrease the proportion (P) gain until the system is stable using the smallest possible control change.
- (2) The integral (I) reduces the system stability which is similar to increasing the gain. Adjust the integral time so that the highest possible proportional gain value can be used without affecting the system stability. An increase in the integral time reduces system response.
- (3) Adjust the differential time if necessary to reduce overshoot on startup. The acceleration / deceleration time can also be used for the same purpose.

Fine-tuning PID control parameters:

- (1) Reduce overshoot

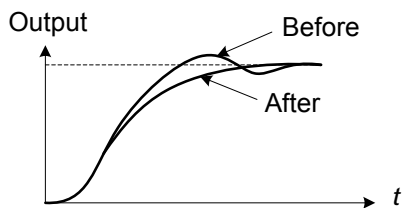

In case overshoot occurs, reduce the derivative time (D) and increase the integral time (I).

- (2) Stabilize PID control

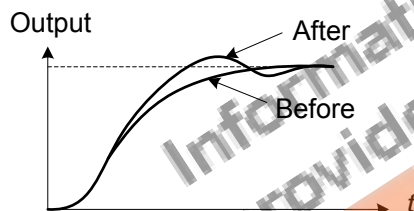

To quickly stabilize the PID control, reduce the integral time (I) and increase the differential time (D) in case overshoot occurs.

- (3) Reduce long-period oscillation

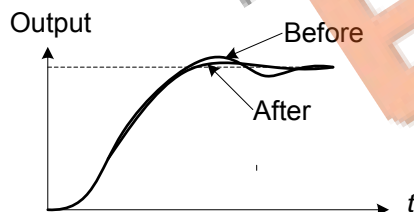

Adjust the integral time (I) in case of long-periodical system oscillation.

- (4) Reduce short-period oscillation

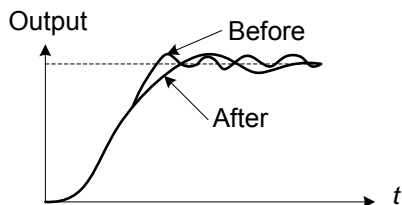

Adjusting the differential time (D) and proportional (P) gain when experiencing short-periodical oscillation.

10-11	PID feedback loss detection selection
Range	0: Disable 1: Warning 2: Fault
10-12	PID feedback loss detection level
Range	0~100 %
10-13	PID feedback loss detection time
Range	0.0~10.0 Sec

The PID control function provides closed-loop system control. In case PID feedback is lost, the inverter output frequency may be increase to the maximum output frequency.

It is recommended to enable to the PID feedback loss when the PID function is used.

PID feedback loss detection

10-11=0: Disable

10-11=1: Warning

A feedback loss condition is detected when the PID feedback value falls below the value set in parameter 10-12 (PID feedback loss detection level) for the time set in parameter 10-13 (PID feedback loss detection time). PID feedback loss warning message "Pb" will be displayed on the keypad and the inverter will continue to operate.

10-11=2: Fault

A feedback loss condition is detected when the PID feedback value falls below the value set in parameter 10-12 (PID feedback loss detection level) for the time set in parameter 10-13 (PID feedback loss detection time). PID feedback loss fault message "Pb" will be displayed on the keypad, the inverter stops and the fault contact is activated.

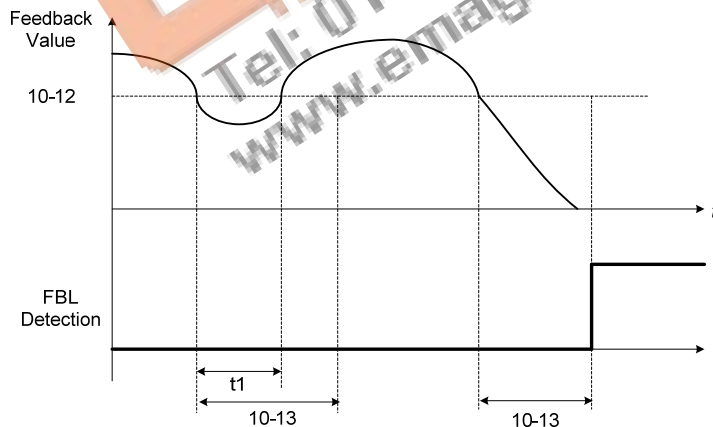

Figure 4.4.82 PID feedback loss detection

10-17	Start frequency of PID sleep
Range	0.00~180.00 Hz
10-18	Delay time of PID sleep
Range	0.0~255.5 Sec
10-19	Frequency of PID wakeup
Range	0.00~180.00 Hz
10-20	Delay time of PID wakeup
Range	0.0~255.5 Sec
10-29	PID sleep selection
Range	0: Disable 1: Enable 2: Set by DI

The PID Sleep function is used to stop the inverter when the PID output falls below the PID sleep level (10-17) for the time specified in the PID sleep delay time parameter (10-18).

The inverter wakes up from a sleep condition when the PID output (Reference frequency) rises above the PID wake-up frequency (10-19) for the time specified in the PID wake-up delay time (10-20).

Use parameter 10-29 to enable / disable PID sleep function.

10-29 =0: PID Sleep function is disabled.

10-29 =1: PID sleep operation is based on parameters of 10-17 and 10-18.

10-29 =2: PID sleep mode is enabled by multi-function digital input

Refer to figure 4.4.83 (a) and (b) for PID sleep / wakeup operation.

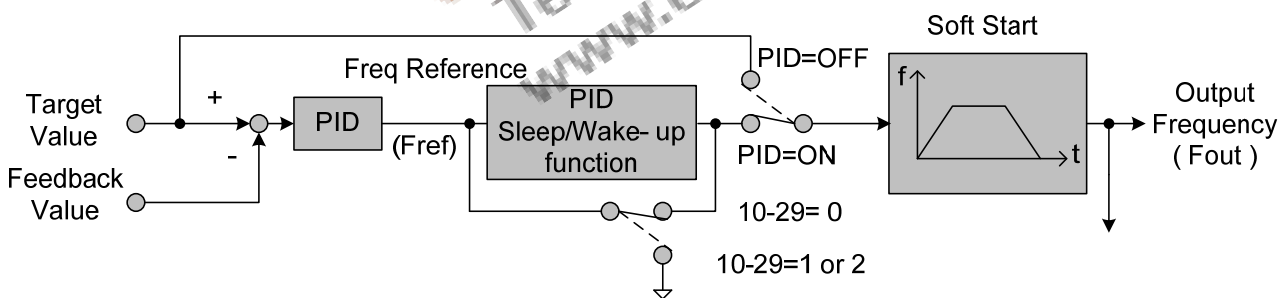

Figure 4.4.83: (a) PID control block diagram

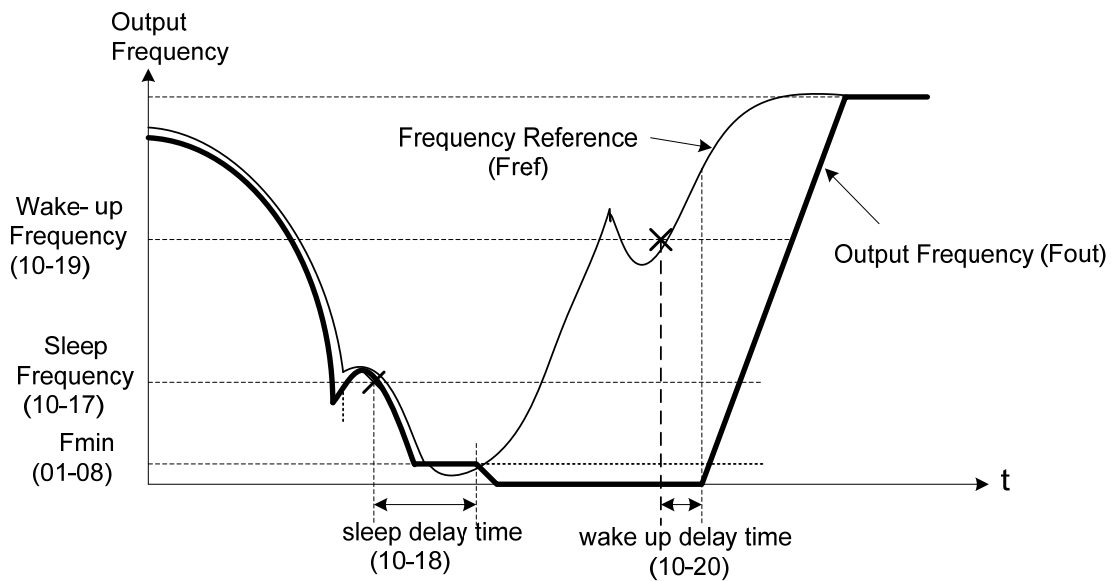

Figure 4.4.83: (b) Timing diagram PID sleep / wakeup

Notes:

The PID sleep timer is enabled when the output frequency (F_{out}) falls below the PID sleep frequency (10-17). When the sleep timer reaches the set PID sleep delay time (10-18) the inverter will decelerate to a stop and enter the sleep mode.

While sleep mode is active and the motor has stopped, the internal PID control is still in operating. When the reference frequency increases and exceeds the wakeup frequency parameter 10-19 for the time specified in the wakeup delay time parameter 10-20, the inverter will restart and the output frequency will ramp up to the reference frequency.

Parameter 10-00 and 10-01 cannot be set to the same source. If both parameters are set to the same source the keypad will show a SE05 alarm.

10-27	PID Feedback Display Bias
Range	-99.99~99.99

10-28	PID Feedback Display Gain
Range	0.00~99.99

PID Feedback Display Scaling

The PID feedback signal can be scaled to represent actual engineering units. Use parameter 10-28 to set the feedback signal gain for the feedback signal range maximum and parameter 10-27 to the feedback signal minimum.

Example:

Feedback signal is a pressure transducer (4-20mA) with a range of 0 – 200 PSI
 4mA = 0 PSI, 20mA = 200 PSI.

Set parameter 10-27 to 0.0 minimum of transducer range (0%).
 Set parameter 10-28 to 2.0 maximum of transducer range (100%).

Refer to the figure 4.4.84 for displaying the unit conversion.

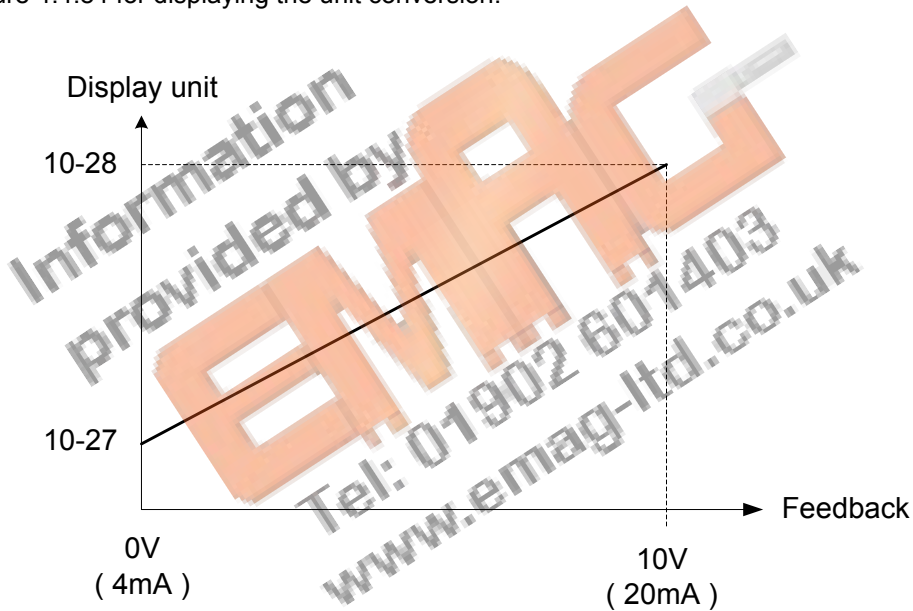

Figure 4.4.84 Feedback signal scaling

11-Auxiliary Parameters

11-00	Direction Lock Selection
Range	0: Allow forward and reverse rotation 1: Only allow forward rotation 2: Only allow reverse rotation

If motor operation direction is set to 1 or 2, the motor can only operate in that specific direction. Run commands in the opposite direction are not accepted.

Forward or reverse commands can be issued via the control terminals or keypad.

Note: The Direction Lock Selection can be used in fan and pump application where reverse rotation is prohibited.

11-01	Carrier frequency
Range	2~16KHz (Default value 2 ~ 8KHz depends on inverter KVA) 0: variable carrier frequency 1: Reserved

Notes:

- (1) Value 2 to 16 represents KHz.
- (2) When 11-01=0, variable carrier frequency is used see parameter 11-30~11-32.
- (3) For SLV and SV mode, the minimum value of 11-01 is 4 kHz.
- (4) Setting range is determined by the inverter rating (13-00) and HD/ND mode (00-27).
- (5) Refer to section 3 inverter derating based on carrier frequency.
- (6) A low carrier frequency increases motor noise but reduces motor losses and temperature.
- (7) A low carrier frequency decreases RFI, EMI interference and motor leakage current.

Refer to the carrier frequency Table 4.4.14.

Table 4.4.14 Carrier frequency settings

Carrier frequency (11-01=2 to 16)	2KHz--6K--10K--16KHz
Motor noise	High ----- Low
Output current waveform	Fair ----- Better
Noise interference	Low----- high
Leakage current	Low----- high

If cable length between the inverter and the motor is too long, the high-frequency leakage current will cause an increase in inverter output current, which might affect peripheral devices. Adjust the carrier frequency to avoid this as shown in table 4.4.15.

Table 4.4.15 Cable length and carrier frequency

Wire length	< 30 Meter (98ft)	up to 50 Meter (164 ft)	up to 100 Meter (328ft)	> 100 Meter* > 328ft
Carrier frequency (11-01 value)	Max. value 16KHz (11-01=16KHz)	Max. value 10KHz (11-01=10KHz)	Maxi. value 5KHz (11-01=5KHz)	Max. value 2KHz (11-01=2KHz)

***. If Cable is longer than 200m, the output dv/dt filter or output reactor is required.**

Notes:

- (1) Reduce the carrier frequency if the torque does not match the speed.
- (2) In V/F and V/F + PG control modes, the carrier frequency is determined by parameters 11-30 (Carrier frequency max. limit), 11-31 (Carrier frequency lower limit) and 11-32 (Carrier frequency proportional gain).

11-02	Soft PWM Function Selection
Range	0: Disable 1: Enable

11-02=0: Soft-PWM control disabled.

11-02=1: Soft-PWM control enabled. Soft-PWM control can improve the 'metal' noise produced by the motor, more comfortable for the human ear. At the same time, Soft-PWM also limits RFI noise to a minimum level. The default setting of Soft-PWM control is disabled. Soft-PWM cannot be set if carrier frequency set in 11-01 is higher than 8 kHz.

11-03	Automatic carrier lowering selection
Range	0: Disable 1: Enable

11-03=0: Automatic carrier frequency reduction during an overheat condition is disabled.

11-03=1: Carrier frequency is automatically lowered in case the inverter heatsink overheated and will return to carrier frequency set in parameter 11-01 when the inverter temperature returns to normal. See section 3 for more information.

11-04	S curve time setting at the start of acceleration
11-05	S curve time setting at the end of acceleration
11-06	S curve time setting at the start of deceleration
11-07	S curve time setting at the end of deceleration
Range	0.00~2.50 Sec

The S curve function for acceleration / deceleration is used to reduce mechanical impact caused by the load during momentary starting and stopping of the inverter. To use the S curve function set the time for acceleration start point (11-04), acceleration end point (11-05), deceleration start point (11-06) and deceleration end point (11-07). Refer to figure 4.4.85 for more information.

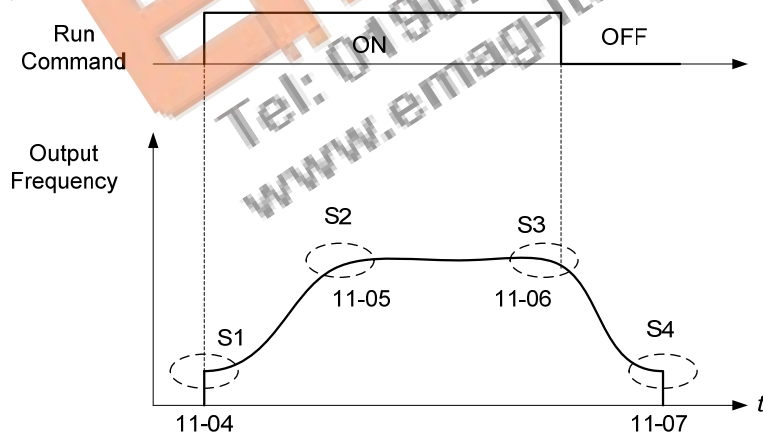

Figure 4.4.85 S curve characteristic

Total acceleration and deceleration time when the S curve is used:

$$\text{Accelerating time} = \text{Accelerating time 1 (or 2)} + \frac{(11-04) + (11-05)}{2}$$

$$\text{Deceleration time} = \text{Deceleration time 1 (or 2)} + \frac{(11-06) + (11-07)}{2}$$

11-08	Jump frequency 1
11-09	Jump frequency 2
11-10	Jump frequency 3
Range	0.0~400.0 Hz 0.0~1200.0 Hz (00-31 = 1)

11-11	Jump frequency width
Range	0.0~25.5 Hz

These parameters allow “jumping over” of certain frequencies that can cause unstable operation due to resonance within certain applications.

Note: Prohibit any operation within the jump frequency range. During acceleration and deceleration the frequency is continuous without skipping the jump frequency.

To enable jump frequency 1 – 3 (11-08 – 11-10) set the frequency to a value greater than 0.0 Hz.

Use the jump frequency width (11-11) to create a jump frequency range. Refer to figure 4.4.86.

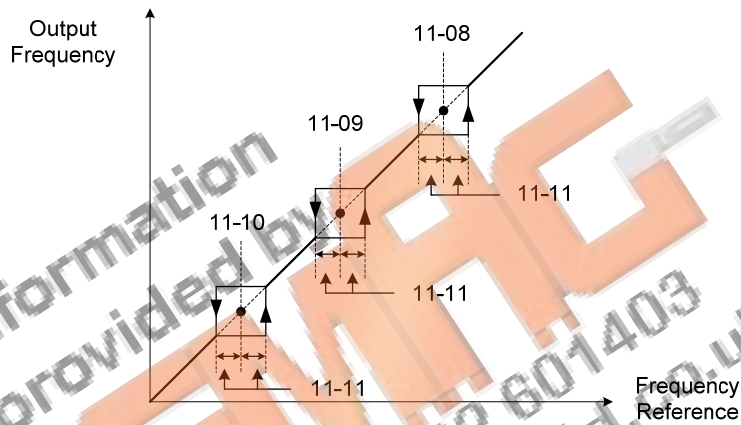

Figure 4.4.86 Jump frequency operation

Jump frequency via Analog Input.

Set parameter 04-05 (AI2 function selection) to 9 (frequency jump setting 4) to control the jump frequency via analog input AI2. Refer to Figure 4.4.48.

Note: When jump frequency overlap the sum of the overlapped jump frequencies will be used as the jump frequency range. Refer to figure 4.4.87.

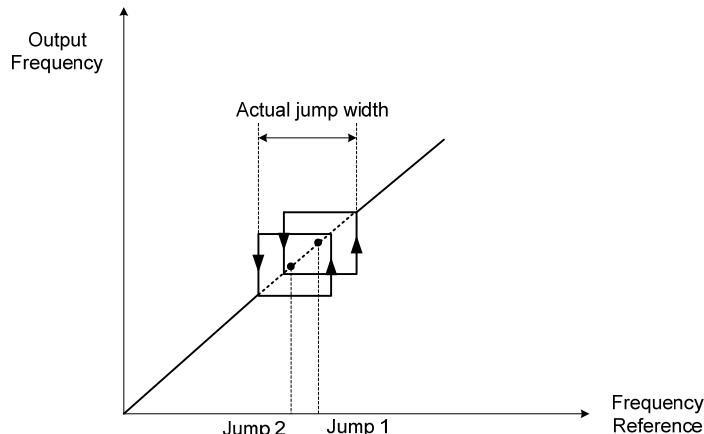

Figure 4.4.87 Jump frequency overlap

11-12	Manual energy saving gain
Range	0~100 %

11-18	Manual energy saving frequency
Range	0.00~400.00 Hz 0.0~1200.0 Hz (00-31 = 1)

Manual energy savings reduces the output voltage for the purpose of saving energy.

To enable manual energy savings set one of the multi-function digital input (03-00 to 03-07) to 20 and activate the input or use parameter 11-18 to set the manual energy savings activation frequency.

When the output frequency rises above the value set in parameter 11-18 manual energy savings function is enabled. Setting parameter 11-18 manual energy savings frequency to 0.0 Hz disables the manual energy savings frequency activation function. Refer to figure 4.4.88 for more information.

Note: Only use manual energy savings functions in combination with light loads.

Manual energy saving gain (11-12) determines the output voltage of the inverter when manual energy savings is enabled. Output voltage is percentage gain times the V/F voltage.

Manual energy saving control uses the voltage recovery time (07-23) to change the output voltage

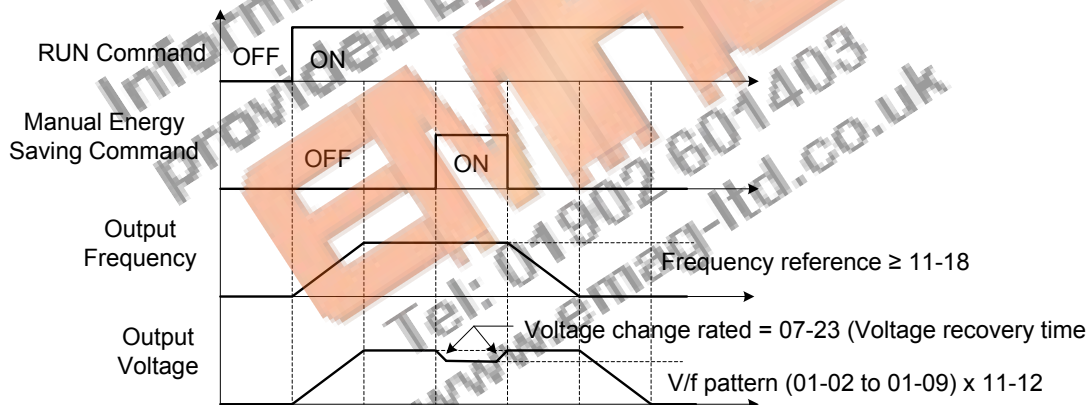

Figure 4.4.88 Manual energy saving operation

11-19	Automatic energy saving function
Range	0: Automatic energy saving is disabled 1: Automatic energy saving is enabled
11-20	Filter time of automatic energy saving
Range	0~200 msec
11-21	Voltage upper limit of energy saving tuning
Range	0~100%
11-22	Adjustment time of automatic energy saving
Range	0~5000 msec
11-23	Detection level of automatic energy saving
Range	0~100%
11-24	Coefficient of automatic energy saving
Range	0.00~655.35

In the V/F control mode the automatic energy saving (AES) function automatically adjusts the output voltage and reduces the output current of the inverter to optimize energy savings based on the load.

The output power changes proportional to the motor load. Energy savings is minimal when the load exceeds 70% of the output power and savings become greater when the load decreases.

The parameter of automatic energy saving function has been set at the factory before shipment. In general, it is no need to adjust. If the motor characteristic has significant difference from the TECO standard, please refer to the following commands for adjusting parameters:

Enable Automatic Energy Savings Function

- (1) To enable automatic energy saving function set 11-19 to 1.
- (2) Filter time of automatic energy saving (11-20)
- (3) Commissioning parameter of energy saving (11-21 to 11-22)

In AES mode, the optimum voltage value is calculated based on the load power requirement but is also affected by motor temperature and motor characteristic.

In certain applications the optimum AES voltage needs to be adjusted in order to achieve optimum energy savings. Use the following AES parameters for manual adjustment:

11-21: Voltage limit value of AES commissioning operation

Sets the voltage upper limit during automatic energy saving. 100% corresponds to 230V or 460V depending on the inverter class used. Refer to the figure 4.4.89.

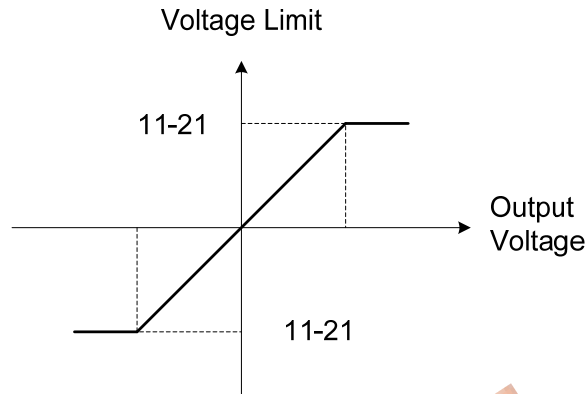

Figure 4.4.89 Voltage limit value of commissioning operation

11-22: Adjustment time of automatic energy saving

Sets sample time constant for measuring output power.

Reduce the value of 11-22 to increase response when the load changes.

Note: If the value of 11-22 is too low and the load is reduced the motor may become unstable.

11-23: Detection level of automatic energy saving

Sets the automatic energy saving output power detection level.

11-24: Coefficient of automatic energy saving

The coefficient is used to tune the automatic energy saving. Adjust the coefficient while running the inverter on light load while monitoring the output power. A lower setting means lower output voltage.

Notes:

- If the coefficient is set to low the motor may stall.
- Coefficient default value is based on the inverter rating. Set parameter 13-00. If the motor power does not match the inverter rating.

11-29	Auto De-rating Selection
Range	0: Disable 1: Enable

The automatic de-rating function automatically reduces the output frequency by 30% of the nominal motor speed when the inverter detects an overheat condition (heatsink).

Automatic de-rating function depends on the automatic carrier frequency reduction selection (11-03).

If automatic carrier frequency reduction is disabled (11-03=0), the output frequency is reduced by 30% of the nominal motor speed when an overheat condition is detected.

If automatic carrier frequency reduction is enabled (11-03=1), the output frequency is reduced by 30% of the nominal motor speed when the carrier frequency is at its minimum setting.

11-29=0: Auto de-rating selection disabled, carrier frequency is based on 11-01 or 11-03.

11-29=1: Auto de-rating selection is enabled.

11-30	Variable Carrier Frequency Max. Limit
Range	2~16 KHz

11-31	Variable Carrier Frequency Min. Limit
Range	2~16 KHz

11-32	Variable Carrier Frequency Proportional Gain
Range	00~99

Carrier frequency method depends on the selected control mode.

Control Mode	Variable Carrier Frequency (11-01 = 0)	Fixed Carrier Frequency (11-01 = 2-16 kHz)
V/F and V/F + PG	Available	Available
SLV and SV	Not available	Available

Variable carrier frequency can be adjust with parameter 11-30 ~ 11-32.

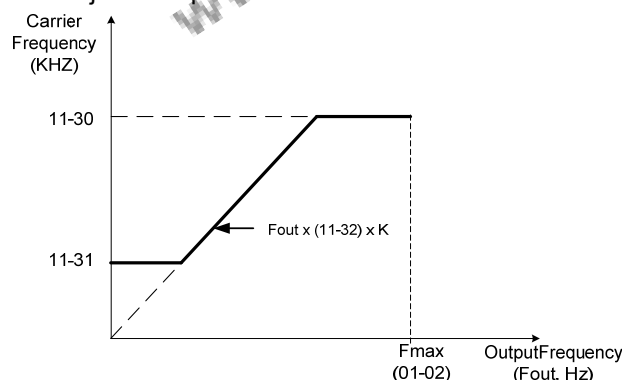

K is a coefficient; the value of K is based on the following based on the maximum carrier frequency:

K=1: when 11-30 < 5 KHz

K=2: when 10 KHz > 11-30 ≥ 5 KHz

K=3: when 11-30 ≥ 10KHz

Notes:

- In V/F and V/F + PG control mode if the speed and torque are constant, the variable carrier frequency mode (11-01=0) can be selected to reduce the carrier frequency based on output frequency.
- If the carrier frequency proportional gain (11-32) > 6 and 11-30 < 11-31, error message "SE01" out of range will appear on the keypad.
- If the minimum limit (11-31) is set higher than the maximum limit (11-30), the minimum limit will be ignored and the carrier frequency will be set at the highest limit (11-30).
- In fixed carrier frequency mode (11-01 = 2-16) parameters 11-30, 11-31 and 11-32 are not used.
- In SLV and SV control mode, the maximum limit of the carrier frequency is fixed at 11-30.

11-33	DC Voltage Filter Rise Amount
Range	0.00~1.00 V
11-34	DC Voltage Filter Fall Amount
Range	0.00~1.00 V
11-35	DC Voltage Filter Deadband Level
Range	0.0~99.0 V
11-36	Frequency gain of OV prevention
Range	0.000~1.000
11-37	Frequency limit of OV prevention
Range	0.00~10.00 Hz
11-38	Deceleration start voltage of OV prevention
Range	200~400 V : 200V 400~800 V : 400V
11-39	Deceleration end voltage of OV prevention
Range	300~600 V : 200V 600~1200 V : 400V
11-40	OV prevention selection
Range	0: Disable 1: Enable

Over-voltage prevention (OVP) function monitors the DC-bus voltage and adjusts the speed reference, acceleration and deceleration rate, to prevent the inverter from tripping on an overvoltage.

When the speed reference is reduced, the motor will start to decelerate. When the inverter is operating at a fixed output frequency and excessive regenerative energy back to the inverter is detected the inverter will accelerate the motor in order to reduce the DC-bus voltage. Refer to figure 4.4.91.

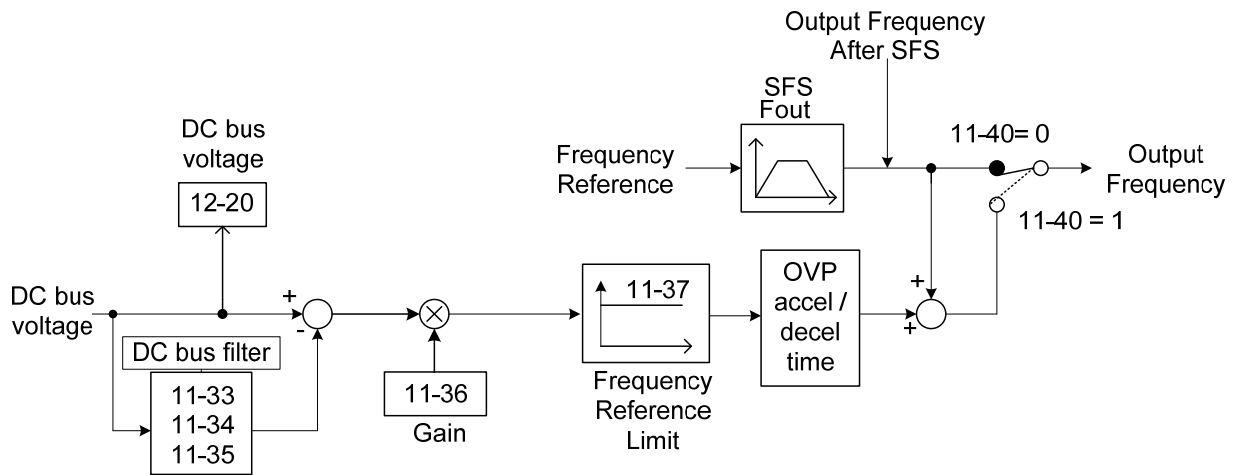

Figure 4.4.91 OVP operation

1) DC voltage filter is used to provide a stable reference value for determining the change in DC voltage change during regenerative operation.

- Adjust the DC voltage filtering increase rate parameter 11-33 (DC Voltage Filter Rise Amount). When the DC voltage exceeds 11-33 + 11-35 (DC Voltage Filter Deadband Level), the output of the filter will increase.
- Adjust the DC voltage filtering decrease rate parameter 11-34 (DC Voltage Filter Fall Amount). When the DC voltage exceeds 11-33 + 11-35 (DC Voltage Filter Deadband Level), the output of the filter will decrease.
- Monitor the DC voltage filter output by 12-20 (DC voltage filter value).
- Set the DC voltage filter decrease rate (11-34) to a greater value than the value of the DC voltage filtering increase rate (11-33).

2) When the inverter is operation at a fixed output frequency, the OVP function will monitor the DC-bus voltage to detect regenerative operation.

In case of a regenerative condition the inverter calculates the delta DC bus voltage value and multiplies the value with parameter 11-36, the result is added to the frequency reference accelerating the motor to prevent on an overvoltage condition.

When the regenerative energy decreases, the inverter output frequency will return to the actual frequency reference. Deceleration rate is based on the DC voltage, as shown in Figure 4.4.92.

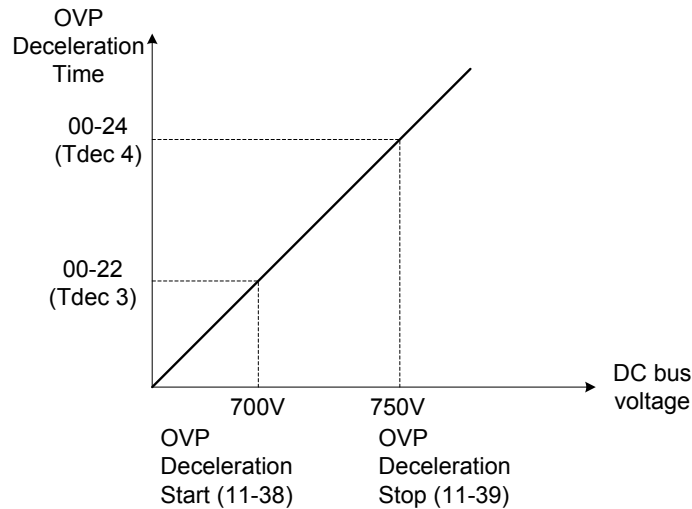

Figure 4.4.92 OVP deceleration time

3) When the inverter is stopped, the deceleration rate can be set with parameter 00-15 (Tdec1). In case the DC voltage is too high, the inverter will decelerate based on the OVP deceleration time as shown in Figure 4.4.92.

- Set DC-bus voltage in parameter 11-38 (start voltage of OVP deceleration) and set OVP deceleration rate in 00-22 (Tdec3).
- When the DC voltage reaches this level, it is necessary to decelerate rapidly in order to prevent the delta DC voltage of becoming too large.
- When DC voltage reaches the setting of 11-39 (stop voltage of OVP deceleration), it will decelerate based on the set value of 00-24 (Tdec4)
- Deceleration rate is linear based on the slope defined by the start point (11-38) and end point (11-39).

4). Enable the OVP function with parameter 11-40 set to 1. The following parameter default values will be changed when the OVP function is enabled:

07-12=1 (Stop mode: coast to stop)

00-14(Tacc1)= 5.0 Sec(the frequency reference acceleration rate when DC voltage is too high.)

00-22(Tdec3)= 20.0 Sec(low setting point of OVP deceleration rate).

00-24(Tdec4)= 100.0 Sec(high setting point of OVP deceleration rate).

Note: S curve should be disabled when using the OVP function (11-04~11-07=0.0sec).

11- 41	Reference frequency loss detection
Range	0: when reference frequency disappears, the deceleration will stop. 1: when reference frequency disappears, continue to operate according to the proportion of reference frequency x 11-42.
11- 42	Reference frequency loss level
Range	0.0~100.0 %

A Reference frequency loss is detected when the frequency command falls 90% within 20ms.

The action performed when a reference loss is detected is set with parameter 11-41.

11-41=0: Inverter will decelerate to a stop when a reference loss is detected.

11-41=1: Inverter will continue to operate; reference frequency is the last know reference frequency x the level set in parameter 11-42.

The inverter will return to normal operation when:

- (1) The reference frequency is restored while running and the reference level exceeds 80% of the master frequency command.
- (2) Stop command is issued.

11-43	Hold frequency at start
Range	0.0~400.0 Hz

11-44	Frequency hold time at start
Range	0.0~10.0 Sec

11-45	Hold frequency at stop
Range	0.0~400.0 Hz

11-46	Frequency hold time at stop
Range	0.0~10.0 Sec

The hold function is used to temporarily hold the reference frequency in order to prevent stalling the motor or preventing an over current condition during starting or stopping due to load conditions.

During start the inverter will operate at the hold frequency at start for the time specified in the parameter 11-44 in order to establish the magnetic flux.

Note: The acceleration or deceleration time does not include the start and stop hold time. Refer to the figure 4.4.94.

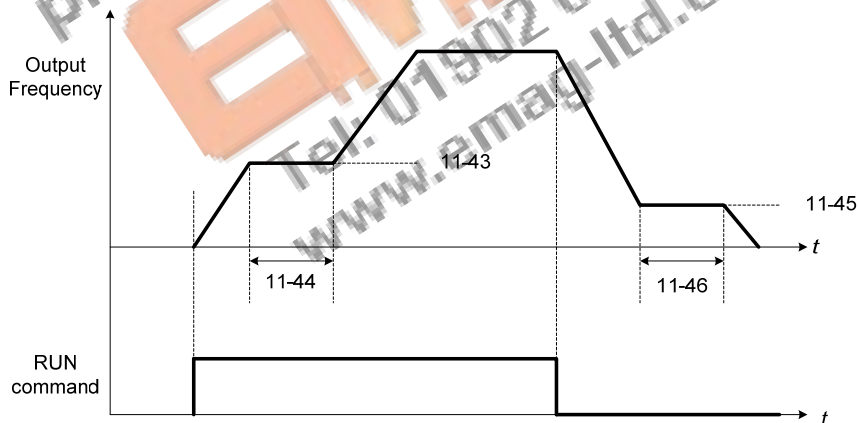

Figure 4.4.94 Reserved function

When the inverter is in stop mode, this function can also be used to prevent wind milling. In addition, it can be used for the purpose of braking using the motor to consume the braking energy resulting in a better controlled stop. Refer to the DC brake parameter 07-16 for DC braking during start.

Notes:

- The hold function at start is inactive when the hold frequency at start (11-43) is set to a value less than Fmin (01-08).

- The hold function at stop is inactive when the hold frequency at stop (11-45) is set to a value less than Fmin (01-08).

11- 47	KEB Deceleration time
Range	0.0~25.5 Sec

11- 48	KEB detection level
Range	190~210 V : 200V 380~420 V : 400V

KEB function can be used to keep the inverter from tripping on a under voltage condition due to a momentary power-loss. To enable the KEB function set parameter 11-47 to a value greater than 0.0 sec.

Upon detection of a power-loss the inverter uses the KEB deceleration time (11-47) to decelerate the motor and using the regenerative energy from the motor to maintain the DC-bus at a nominal level.

11-48: KEB detection level

If the DC-bus voltage falls below the value set in 11-48, the KEB is activated and the inverter starts decelerating according to the value set in 11-47.

To accelerate back to the original output frequency one of the digital inputs (03-00 to 03-07) set for 48 (KEB acceleration) has to be activated and the DC voltage has to rise above 11-48 + delta V (Delta V = +10V for 230V series, Delta V = +20 V for 460V Series).

Refer to the example in Figure 4.4.95.

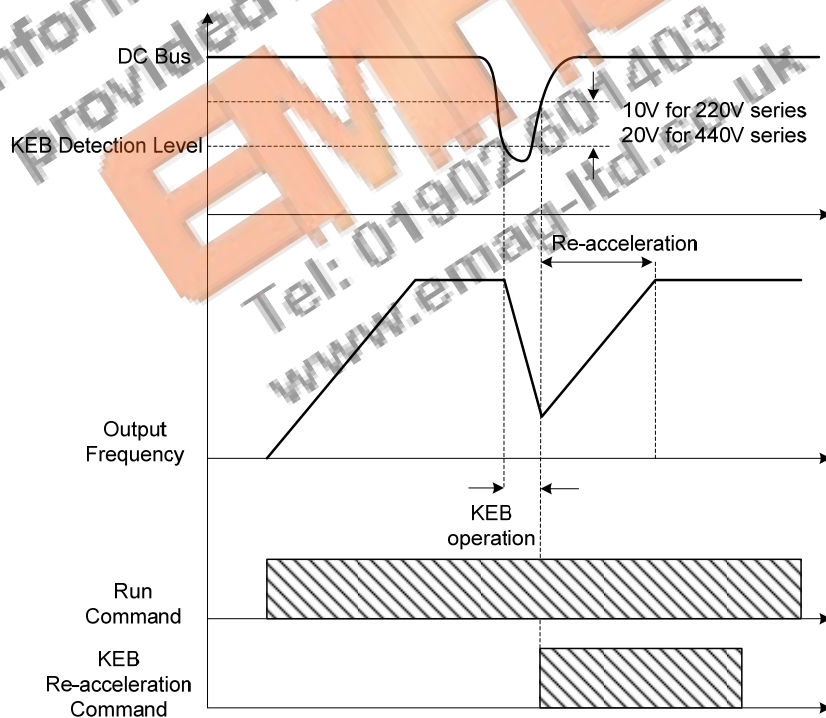

Figure 4.4.95 KEB operation

11- 49	Zero-servo gain
Range	0~50
11- 50	Zero-servo count
Range	0~4096
11- 51	Braking selection of zero-speed
Range	0: Zero-speed DC braking is disabled 1: Zero-speed DC braking is enabled

When the motor is stopped, the zero-servo function is used to maintain the motor shaft position in SV control mode.

Refer to the figure 4.4.96 for zero servo operation.

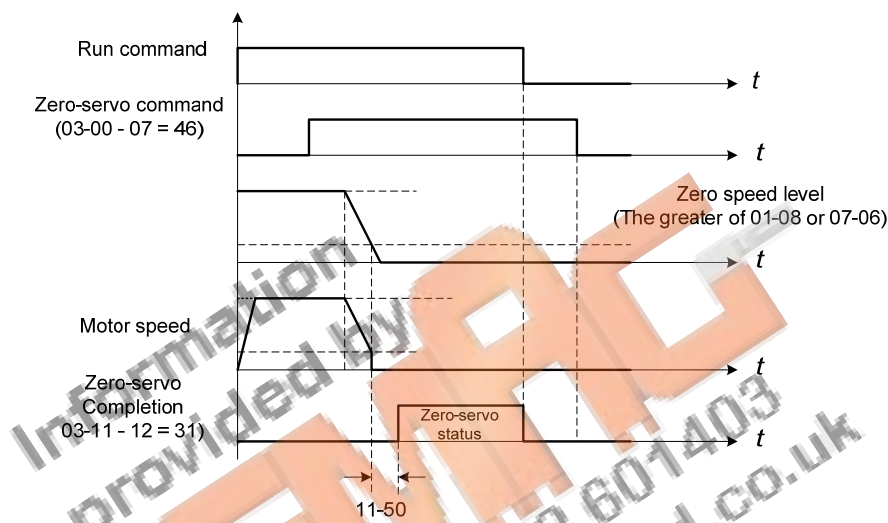

Figure 4.4.96 Zero-servo operation

- Use one of multi-function digital inputs (03-00 to 03-07) set to 46 to execute the zero-servo command.
- If the frequency reference is lower than the zero speed level (the larger of 01-08 or 07-06 (DC braking start frequency)), zero servo operation is active (zero servo start position) and the motor shaft will remain in the same position even if the analog reference signal level is greater than 0.
- Deactivating multi-function input set for zero-servo, deactivates the zero-servo operation.
- Use multi-function digital outputs (03-11, 03-12 = 31) for zero-servo completed indication.
- Zero-servo count 11-50 is used when one of multi-function digital outputs is set to 31 (zero-servo completed).
- Zero-servo completion is enabled when the motor shaft position count falls within the zero-servo starting position \pm servo counts set in parameter 11-50.
- Zero-servo or normal operation command is active when zero-servo completion signal is turned off.

11-49: Zero-servo gain setting

Use the zero-servo gain parameter 11-49 to adjust the holding torque in zero-servo operation. If the set value is increased, the holding torque will increase but instability may occur. Do not use the zero-servo function at 100% of the inverter rated current as this may cause the inverter to overheat (OH1). Zero-servo may permanently be used to maintain 50 – 60% of the inverter rated current. Increase inverter rating if more is required.

11-50: Zero-servo count

Zero servo count is used to specify the zero-servo position offset from the zero-servo start position used for zero-servo completion.

11-51: Operation selection of zero-speed braking

In V/F control mode, the DC braking operation (without PG feedback) can be used to the motor shaft. Set 11-51 to select zero-speed braking operation to 1 to enable this function.

To use DC braking operation set parameter 00-02 (operation command selection) to 1 and parameter 00-05 (frequency reference selection) to 1, the operation command and frequency reference are now set for external control. When the frequency reference is 0V (or less than 4mA), and the operation command is turned on, the zero-speed 'DC' braking operation is activated and holding torque is generated using DC braking.

Refer to Figure 4.3.97 for more information on zero-speed DC braking operation.

Note: DC braking 07-07 is limited to 20% of the inverter rated current.

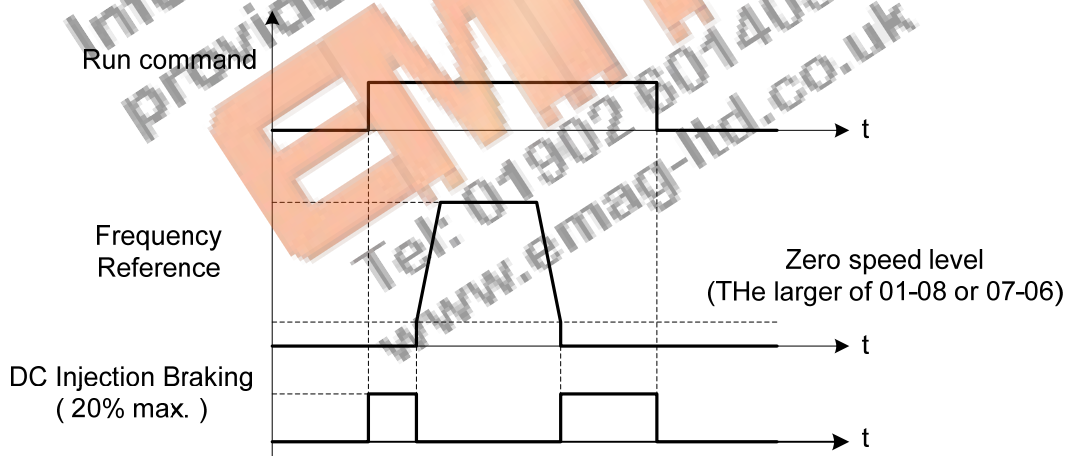

Figure 4.4.97 Zero-speed braking operation

11-52	Droop control level
Range	0.01~2.00
11-53	Droop control delay
Range	0.00~2.00 Sec

Droop control is used for load balancing when using two standard AC motors to drive the load in applications such as cranes and conveyors. When droop control is active the inverter reduces the speed when the torque reference rises and increases the speed when the torque reference drops.

(a) Load balancing using the standard AC motors.
 The load torque of motor A, $T_A >$ The load torque of motor B, T_B .

(b) Load balancing using high slippage AC motors.
 The load torque of motor A, T_A is very close to the load torque of motor B, T_B .

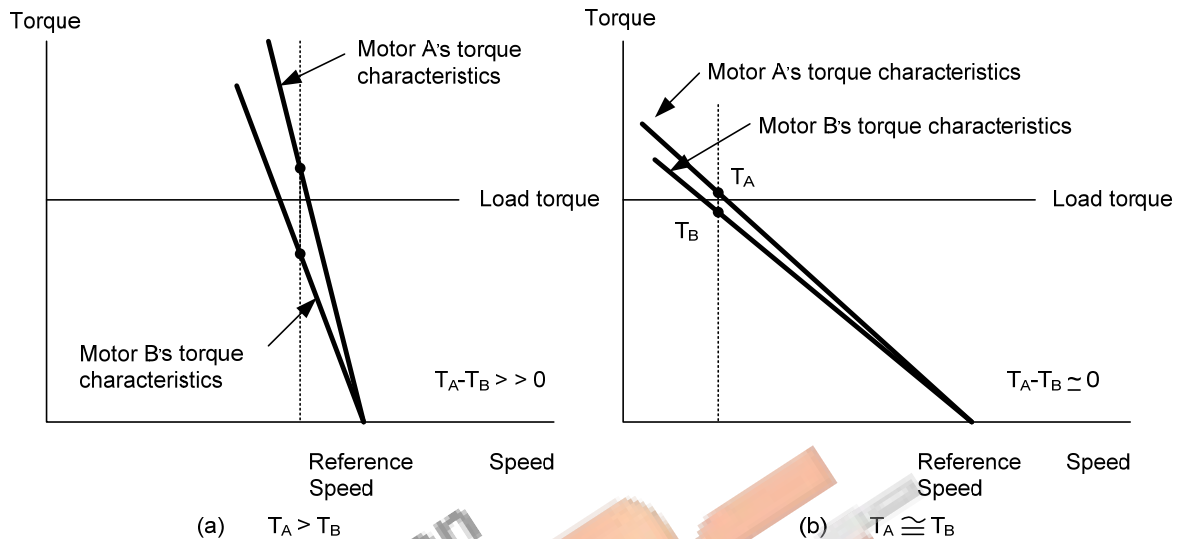

- Droop function can be used to approximate the characteristic of a high slippage motor. Set 11-52 to the percentage of the speed reduction that amounts to 100% of motor torque based on the maximum frequency (01-02).
- Droop function is disabled when 11-52 is set to 0.0%.

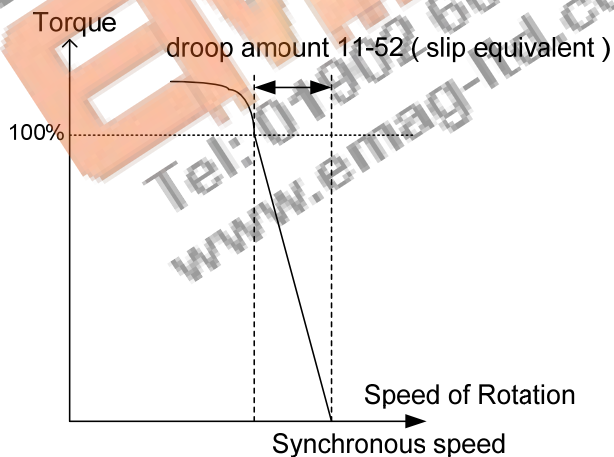

11-53: Droop control delay

This setting is used adjust the response speed of the droop function. Increase value in case of current oscillation.

11-54	Output KWHr initialization
Range	0: Do not clear output KWHr 1: Clear output KWHr

Reset kW-hour meter (12-40).

11-55	STOP key selection
Range	0: Stop key is disabled when the operation command is not provided by operator. 1: Stop key is enabled when the operation command is not provided by operator.

11-55= 0: Stop button disabled when operation command is set for terminals (00-02=1) or communication (00-02=3).

11-55= 1: Stop button enabled

11-56	UP/DOWN selection
Range	0: UP/DOWN reference frequency adjustment with ENTER key. 1: UP/DOWN reference frequency adjustment without ENTER key.

11-56= 0: Changing the reference frequency on the keypad in UP/DOWN control requires the ENTER button to be pressed for the inverter to accept the modified reference frequency.

11-56= 1: Changing the reference frequency on the keypad in UP/DOWN control immediately changes the reference frequency and there for the output frequency.

Note: The reference frequency can be changed (up or down) via the keypad or by setting one of multi-functional digital input terminals (03-00, 03-07) to 8 and 9. Refer to instructions of (03-00 - 03-07 = 8 or 9).

11- 58	Record reference frequency
Range	0: Disable 1: Enable

This function is enabled only when one of multi-function digital input terminals (03-00 to 03-07) is set to 11 (ACC / DEC disabled) or to 8 and 9 (up / down). Refer to the figure 4.4.21 for the acceleration / deceleration disabled, and figure 4.4.20 for up / down operation.

12-Monitoring Parameters

12-00	Display screen selection (LED)
Range	<p>Highest bit => 0 0 0 0 <= lowest bit</p> <p>The value range of each bit is 0~7 from the highest bit to the lowest bit,</p> <p>0: No display 1: Output current 2: Output voltage 3: DC bus voltage 4: Heatsink temperature 5: PID feedback 6: AI1 value 7: AI2 value</p>

Note: The highest bit is used for power-up monitor. The 4 least significant bits can be used to customize the display sequence see chapter 4.1.3.

12-01	PID feedback display mode (LED)
Range	<p>0: Display the feedback value in integer (xxx)</p> <p>1: Display the feedback value with one place after the decimal point (xx.x)</p> <p>2: Display the feedback value (x.xx) with two places after the decimal point</p>

12-02	PID feedback display unit setting (LED)
Range	<p>0: xxxxx (no unit)</p> <p>1: xxxPb (pressure)</p> <p>2: xxxFL (flow)</p>

12-05	Status display of digital input terminal (LED / LCD)
Range	Read-only

Terminals S1-S8 are represented using two segments of each digit. Segment turns on when input is active. The bottom segments of each of the first three digits are used to represent the digital outputs (R1, R2, DO1). Segments turn on when output is active.

Example1: S1~S8, R1, R2 and DO1 are ON

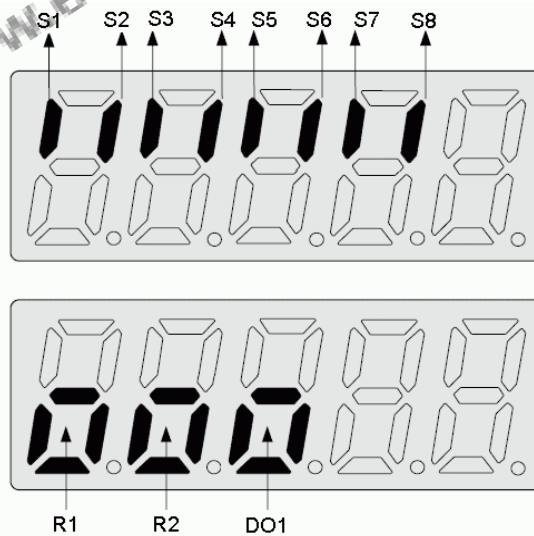

Example2: S1~S8, R1, R2 and DO1 are OFF

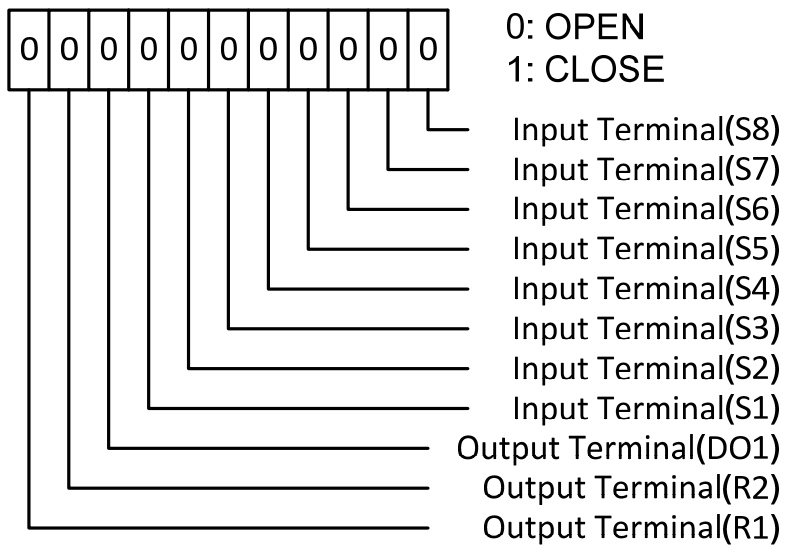

Note: Refer to section 4.3 for monitors 12-11~12-64.

Information
provided by
EMAG
Tel: 01902 601403
www.emag-ltd.co.uk

13-Maintenance Parameters

13-00	Inverter Capacity Selection
Range	----

Inverter model:	13- 00 display	Inverter model:	13- 00 display
A510-2001-XXX	201	A510-4001-XXX	401
A510-2002-XXX	202	A510-4002-XXX	402
A510-2003-XXX	203	A510-4003-XXX	403
A510-2005-XXX	205	A510-4005-XXX	405
A510-2008-XXX	208	A510-4008-XXX	408
A510-2010-XXX	210	A510-4010-XXX	410
A510-2015-XXX	215	A510-4015-XXX	415
A510-2020-XXX	220	A510-4020-XXX	420
A510-2025-XXX	225	A510-4025-XXX	425
A510-2030-XXX	230	A510-4030-XXX	430
A510-2040-XXX	240	A510-4040-XXX	440
A510-2050-XXX	250	A510-4050-XXX	450
A510-2060-XXX	260	A510-4060-XXX	460
A510-2075-XXX	275	A510-4075-XXX	475
A510-2100-XXX	2100	A510-4100-XXX	4100
A510-2125-XXX	2125	A510-4125-XXX	4125
A510-2150-XXX	2150	A510-4150-XXX	4150
		A510-4175-XXX	4175
		A510-4215-XXX	4215
		A510-4250-XXX	4250
		A510-4300-XXX	4300
		A510-4375-XXX	4375
		A510-4425-XXX	4425

13-01	Software version
Range	----

13- 03	Cumulative operation hours 1
Range	0~23 hours

13- 04	Cumulative operation hours 2
Range	0~65535 days

13-05	Selection of cumulative operation time
Range	0: Accumulative operation time while power on 1: Accumulative operation time when it is operating.

13-05= 0: Inverter logs the time while the inverter is powered-up.

13-05= 1: Inverter logs the time when the inverter is running.

13-06	Parameters lock
Range	0: Parameters are read-only except 13-06 1: Reserved

	2: All parameters are writable
--	---------------------------------------

13-07	Parameter password function
Range	0~9999

13-08	Restore factory setting / Initialize
Range	0: No Initialization 1: Reserved 2: 2-wire initialization (220/440V) [60Hz] 3: 3-wire initialization (220/440V) [60Hz] 4: 2-wire initialization (200/415V) [60Hz] 5: 3-wire initialization (200/415V) [60Hz] 6: 2-wire initialization (200/380V) [60Hz] 7: 3-wire initialization (200/380V) [60Hz] 8: PLC initialization Other: Reserved

Use parameter 13-08 to initialize the inverter to factory default. It is recommended to write down the modified parameters before initializing the inverter. After initialization, the value of 13-08 will return to zero automatically.

13-08=2: 2-wire initialization (220V/440V)

Multi-function digital input terminal S1 controls forward operation / stop command, and S2 controls reverse operation / stop command. Refer to Figure 4.4.1.

Inverter input voltage (01-14) is automatically set to 220V (200V class) or 440V (400V class)

13-08=3: 3-wire initialization (220V/440V)

Multi-function digital input terminal S7 controls the forward / reverse direction, and terminals S1 and S2 are set for 3-wire start operation and stop command.

Refer to Figure 4.4.2 and Figure 4.4.3 for 3-wire type operation mode.

Inverter input voltage (01-14) is automatically set to 220V (200V class) or 440V (400V class)

13-08=4: 2-wire initialization (230V/415V)

Multi-function digital input terminal S1 controls forward operation / stop command, and S2 controls reverse operation / stop command. Refer to Figure 4.4.1.

Inverter input voltage (01-14) is automatically set to 220V (200V class) or 440V (400V class)

13-08=5: 3-wire initialization (230V/415V)

Multi-function digital input terminal S5 controls the forward / reverse direction, and terminals S1 and S2 are set for 3-wire start operation and stop command.

Inverter input voltage (01-14) is automatically set to 220V (200V class) or 440V (400V class)

13-08=6: 2-wire initialization (200V/380V)

Multi-function digital input terminal S1 controls forward operation / stop command, and S2 controls reverse operation / stop command. Refer to Figure 4.4.1.

Inverter input voltage (01-14) is automatically set to 220V (200V class) or 440V (400V class)

13-08=7: 3-wire initialization (200V/380V)

Multi-function digital input terminal S5 controls the forward / reverse direction, and terminals S1 and S2 are set for 3-wire start operation and stop command.

Inverter input voltage (01-14) is automatically set to 220V (200V class) or 440V (400V class)

13-08=8: PLC initialization

Clear built-in PLC ladder logic and related values.

13-09	Fault history clearance function
Range	0: Do not clear fault history 1: Clear fault history

13-09=1: Clears inverter fault history

Information
provided by
EMAG
Tel: 01902 601403
www.emag-ltd.co.uk

14-PLC Parameters

14-00	T1 set value 1
14-01	T1 set value 2 (mode 7)
14-02	T2 set value 1
14-03	T2 set value 2 (mode 7)
14-04	T3 set value 1
14-05	T3 set value 2 (mode 7)
14-06	T4 set value 1
14-07	T4 set value 2 (mode 7)
14-08	T5 set value 1
14-09	T5 set value 2 (mode 7)
14-10	T6 set value 1
14-11	T6 set value 2 (mode 7)
14-12	T7 set value 1
14-13	T7 set value 2 (mode 7)
14-14	T8 set value 1
14-15	T8 set value 2 (mode 7)
Range	0~9999

14-16	C1 set value
14-17	C2 set value
14-18	C3 set value
14-19	C4 set value
14-20	C5 set value
14-21	C6 set value
14-22	C7 set value
14-23	C8 set value
Range	0~65535

14-24	AS1 set value 1
14-25	AS1 set value 2
14-26	AS1 set value 3
14-27	AS2 set value 1
14-28	AS2 set value 2
14-29	AS2 set value 3
14-30	AS3 set value 1
14-31	AS3 set value 2
14-32	AS3 set value 3
14-33	AS4 set value 1
14-34	AS4 set value 2
14-35	AS4 set value 3
Range	0~65535

14-36	MD1 set value 1
14-37	MD1 set value 2
14-38	MD1 set value 3
14-39	MD2 set value 1
14-40	MD2 set value 2
14-41	MD2 set value 3
14-42	MD3 set value 1
14-43	MD3 set value 2
14-44	MD3 set value 3
14-45	MD4 set value 1
14-46	MD4 set value 2
14-47	MD4 set value 3
Range	0~65535

Please refer to section 4.5 for built-in PLC function

15-PLC Monitoring Parameters

15-00	T1 current value 1
15-01	T1 current value 2 (mode 7)
15-02	T2 current value 1
15-03	T2 current value 2 (mode 7)
15-04	T3 current value 1
15-05	T3 current value 2 (mode 7)
15-06	T4 current value 1
15-07	T4 current value 2 (mode 7)
15-08	T5 current value 1
15-09	T5 current value 2 (mode 7)
15-10	T6 current value 1
15-11	T6 current value 2 (mode 7)
15-12	T7 current value 1
15-13	T7 current value 2 (mode 7)
15-14	T8 current value 1
15-15	T8 current value 2 (mode 7)
Range	0~9999

15-16	C1 current value
15-17	C2 current value
15-18	C3 current value
15-19	C4 current value
15-20	C5 current value
15-21	C6 current value
15-22	C7 current value
15-23	C8 current value
Range	0~65535

15-24	AS1 current value
15-25	AS2 current value
15-26	AS3 current value
15-27	AS4 current value
15-28	MD1 current value
15-29	MD2 current value
15-30	MD3 current value
15-31	MD4 current value
15-32	TD current value
Range	0~65535

16-LCD Function group	
------------------------------	--

16-00	Main screen monitoring
Range	5~67

16-01	Sub-screen monitoring 1
Range	5~67

16-02	Sub-screen monitoring 2
Range	5~67

At power-up the inverter shows two monitor section on the display, main monitor section and the sub-screen monitor section (smaller font).

Choose the monitor signal to be displayed as the main-screen monitor screen in parameter 16-00, and the monitor signals to be displayed on the sub-screen monitor in parameters 16-01 and 16-02, similar to monitor parameters 12-5 ~ 12-64.

16-03	Display unit
Range	0: Display unit is Hz (Resolution is 0.01Hz) 1: Display unit is % (Resolution is 0.01%) 2~39: Display unit rpm, (uses number of motor poles to calculate) 40~9999: 100% is XXXX with no decimals (integer only) 10001~19999: 100% is XXX.X with 1 decimal 20001~29999: 100% is XX.XX with 2 decimals 30001~39999: 100% is X.XXX with 3 decimals

16-04	Engineering unit
Range	0: No Unit 1: FPM 2: CFM 3: PSI 4: GPH 5: GPM 6: IN 7: FT 8: /s 9: /m 10: /h 11: °F 12: inW 13: HP 14: m/s 15: MPM 16: CMM 17: W 18: KW 19: m 20: °C

(1). Display unit of digital operator (16-03)

Set the units of the following items to be displayed, the frequency reference (05-01, 00-18, 06-01~06-15) and the monitoring frequency 12-16, 12-17 (Output frequency)

(2). Display unit of engineering (16-04).

When 16-03 = 00040-39999, engineering units are enabled. The displayed set range and the frequency range of unit (05-01, 06-01~06-15) as well as the monitoring frequency (12-16, 12-17) are changed by parameters 16-04 and 16-03.

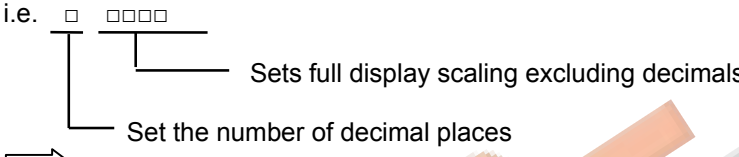
16-03	Set / displayed contents			
0	0.01 Hz			
1	0.01 % (maximum output frequency 01-02=100%)			
2 - 39	RPM (RPM = 120 x reference frequency / the number of motor pole. The number of motor pole is set by 16-03)			
00040 - 39999	Set the decimal point by using the fifth place. i.e. $\square \square \square \square \square$ 			
	16-03	Display	Display unit	
	00040 – 09999	$\square \square \square \square$	use 16-04 setting	Display example Example: 100 % speed is 0200 > set 16-03=00200 (from 05-01, 06-01 to 06-15, set range from 0040 to 9999). > set 16-04=0 (no unit)
	10000 – 19999	$\square \square \square . \square$		Example: 100 % speed is 200.0 CFM > set 16-03=12000 (05-01, 06-01 to 06-15, set range from 0000 to 9999). > set 16-04=2 (CFM) > 60% speed will be displayed as 120.0 CFM
	20000 – 29999	$\square \square . \square \square$		Example: 100 % speed is 65.00°C > set 16-03=26500 (05-01, 06-01 to 06-15, set range from 0000 to 9999) > set 16-04=20 (°C) > 60% of speed is displayed as 39.00 °C
30000 – 39999	$\square . \square \square \square$		Example: 100 % speed is 2.555 m/s > set 16-03=32555 > set 16-04=14 (m/s) > 60% speed is displayed as 1.533 m/s	

16-05	LCD backlight
Range	0~7

Adjust the screen contrast of the digital operator. If it is set to 0, the screen backlight is turned off.

16-06	Automatic return time
Range	0~120 sec

If the digital operator is not pressed within the time specified in 16-06 (returning time of automatic back button), the digital operator will automatically return to the mode screen.

When it is set to 0, the automatic return function is turned off. Press the back button to return to the previous directory.

16-07	Copy function selection
Range	0: Do not copy parameter 1: Read inverter parameters and save to the keypad 2: Write the keypad parameters to inverter 3: Compare parameters of inverter and keypad

16-08	Selection of allowing reading
Range	0: Do not allow to read inverter parameters and save to the keypad 1: Allow to read inverter parameters and save to the keypad

LCD digital operator with built-in memory (EEPROM) can be used to store and retrieve parameters:

- (1) Read: Save inverter parameters to the digital operator (INV → OP).
- (2) Write: Write the parameters from the digital operator to the inverter and save (OP → INV).
- (3) Verify: Compare the inverter parameters against the parameters in the digital operator.

16-07=0: No action

16-07=1: Read (all parameters are copied from the inverter to the keypad).

16-07=2: Write (all parameter are copied from the keypad to the inverter).

16-07=3: Verify (Compare the set value of the inverter to the parameter of the digital operator).

Set 16-08 = 0, to prevent the saved parameter data stored in the digital operator from accidentally being overwritten.

When parameter 16-08=0 and the read operation is executed (16-07=1) a warning message of "RDP Read Prohibited" will be displayed on the keypad and the read operation is cancelled.

Refer to the following steps for copy function operation.



For the write-in operation requires the following items to match.

- (1) Software version
- (2) Control method
- (3) Inverter type
- (4) Inverter rated capacity and voltage

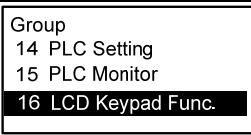
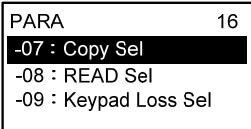
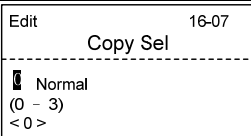
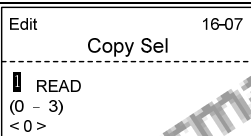

Set one of the parameters 03-00 to 03-07 (multi-function digital input selection) to 49 (Enable the parameter write-in function) to enable or disable the parameter write-in function.

When terminal is active, parameters can be copied from the digital operator to the inverter. When the terminal is not active inverter parameters are prohibited from write-in, excluding the reference frequency (00-05).

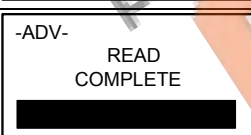
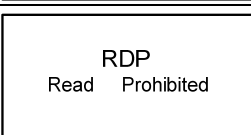
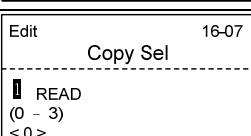

■ **READ: Copy inverter parameters to the keypad**

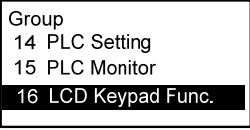
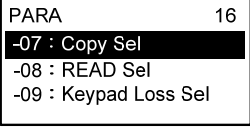
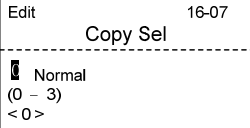
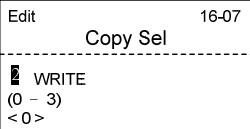
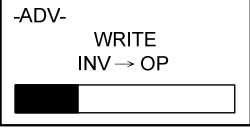
Steps	Keypad (English)	Description
1		Select the copy function group (16) from the group menu.
2		Press the Read / Enter key and select parameter (16-07) copy sel.
3		Press the Read / Enter key to display the data setting / read screen (LCD display is inversed).
4		Change the set value to 1 (read) by using the up arrow key.
5		<ul style="list-style-type: none"> • Use Read / Enter key to enable the read operation, the display is shown as the left. • The bottom of LCD display will show a bar to indicate the read progress.
6		"READ COMPLETE" will be displayed on the keypad when reading was successful.
		<ul style="list-style-type: none"> • The error message of "RDP Read Prohibited" may occur on the keypad when reading parameters from the inverter is prohibited. • If the error is displayed, press any key to remove the error message and go back to parameter 16-07.
7		When DSP/FUN key is pressed, the display returns to parameter 16-07.

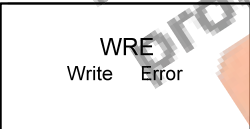
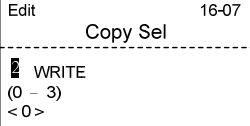
■ **WRITE: Copy Keypad parameters to the Inverter**

Steps	LCD Display (English)	Description
1		Select the copy function group (16) from the group menu.
2		Press the Read / Enter key and select parameter (16-07) copy sel.
3		Press the Read / Enter key to display the data setting / read screen (LCD display is inverted).
4		Change the set value to 2 (write) by using the up arrow key.
5		<ul style="list-style-type: none"> • Use Read / Enter key to enable the read operation, the display is shown as the left. • The bottom of LCD display will show a bar to indicate the read progress.
6		“WRITE COMPLETE” will be displayed on the keypad when writing was successful.
		<ul style="list-style-type: none"> • The error message of “WRE Write Error ” may occur on the keypad when writing parameters to the inverter is prohibited. • If the error is displayed, press any key to remove the error message and go back to parameter 16-07.
7		When DSP/FUN key is pressed, the display returns to parameter 16-07.

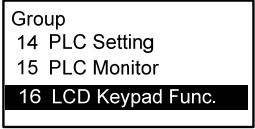
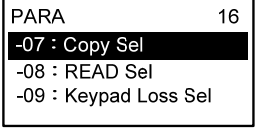
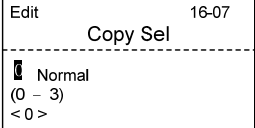
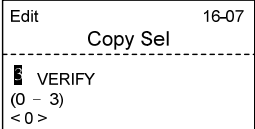
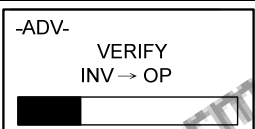
■ **Verify: Compare Inverter Parameters against Keypad Parameters**

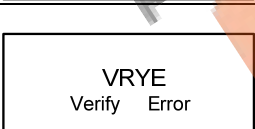
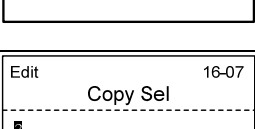
Steps	LCD Display (English)	Description
1		Select the copy function group (16) from the group menu.
2		Press the Read / Enter key and select parameter (16-07) copy sel.
3		Press the Read / Enter key to display the data setting / read screen (LCD display is inversed).
4		Change the set value to 3 (verify) by using the up arrow key.
5		<ul style="list-style-type: none"> • Use Read / Enter key to enable the read operation, the display is shown as the left. • The bottom of LCD display will show a bar to indicate the read progress.
6		"VERIFY COMPLETE" will be displayed on the keypad when writing was successful.
		<ul style="list-style-type: none"> • The error message of "VRYE Verify Error " may occur on the keypad when writing parameters to the inverter is prohibited. • If the error is displayed, press any key to remove the error message and go back to parameter 16-07.
7		When DSP/FUN key is pressed, the display returns to parameter 16-07.

16-09	Selection of keypad removed (LCD)
Range	0: Keep operating when LCD keypad is removed. 1: Display fault when LCD keypad is removed.

16-09=0: Continue operating when keypad is removed.

16-09=1: Trip inverter when keypad is removed while operating in local mode.

17-Automatic Tuning Parameters

17-00	Mode selection of automatic tuning
Range	0: Rotation auto-tune 1: Static auto-tune 2: Stator resistance measurement (V / F) 3: Reserved 4: Loop test
17-01	Motor rated output power
Range	0.00~600.00 kW
17-02	Motor rated current
Range	For VF, VF+PG modes, 10%~200% of the inverter rated current For SLV, SV modes, 25%~200% of the inverter rated current.
17-03	Motor rated voltage
Range	0.0~255.0 V: 200V 0.0~510.0 V: 400V
17-04	Motor rated frequency
Range	10.0~400.0 Hz 10.0~1200.0 Hz (00-31 = 1)
17-05	Motor rated speed
Range	0~24000 rpm
17-06	Pole number of motor
Range	2,4,6,8,10,12,14,16 pole
17-07	Number of PG pulse
Range	0~60000 PPR
17-08	Motor no-load voltage
Range	50~240 V: 200V 100~480 V: 400V
17-09	Motor excitation current
Range	0.01~600.00 A
17-10	Automatic tuning start
Range	0: Disable 1: Enable

17-11	Error history of automatic tuning
Range	0: No error 1: Motor data error 2: Stator resistance tuning error 3: Leakage induction tuning error 4: Rotor resistance tuning error 5: Mutual induction tuning error 6: Encoder error 7: DT Error 8: Motor's acceleration error 9: Warning

Notes:

- Values are for 200V class, double the values for 400V class.
- In HD mode (00-27=0) the range is 0.0 to 400.0 Hz, 0.0 to 120.0Hz in for ND mode (00-27=1) and 0.0 to 1200.0Hz is high frequency mode (00-31=1).

Auto-tuning

Based on the motor nameplate set the motor rated output power (17-01), motor output rated current (17-02), motor rated voltage (17-03), motor rated frequency (17-04), motor rated speed (17-05) and number of motor poles (17-06) to perform an auto-tune.

- Automatic tuning mode selection (17-00)

17-00=0: Perform rotational auto-tune (High performance auto-tune)

17-00=1: Perform a static non-rotational auto-tune

17-00=2: Perform stator resistance non-rotational auto-tune (V/F mode) when using long motor leads

17-00=3: Reserved

17-00=4: Performance adjustment for in vector control mode

- Motor rated output power (17-01)
Set by inverter capacity (13-00)
- Motor rated current (17-02)
Set by inverter capacity (13-00)
Set the range to 10 %~200 % of the inverter rated current.
- Motor rated voltage (17-03)
- Motor rated frequency (17-04)
- Motor rated speed (17-05)

When tuning a special motor (e.g. constant power motor, high-speed spindle motor), with a motor rated voltage or rated motor frequency that is lower than a standard AC motor, it is necessary to confirm the motor nameplate information or the motor test report.

Prevent the inverter output voltage from saturation when the motor rated voltage is higher than the inverter input voltage (see Example 1).

Example 1: Motor rated voltage (440V/60Hz) is higher than the inverter input voltage (380V/50 Hz).

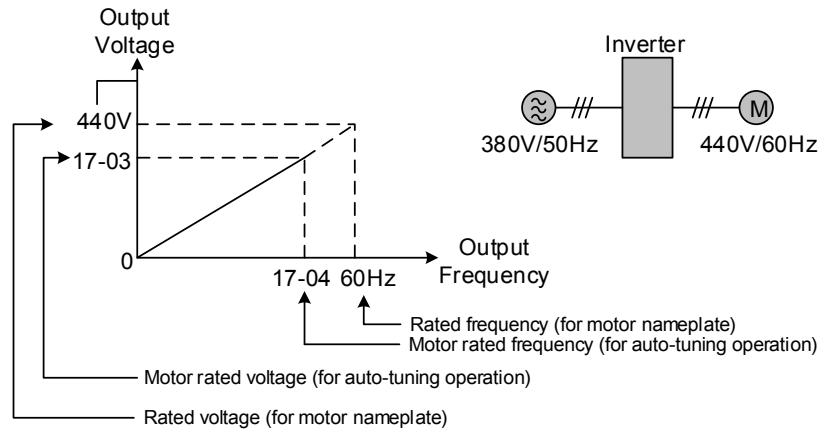

Figure 4.4.98 Rated voltage and frequency settings

Step 1: Set motor rated voltage, 17-03=440V.

Step 2: Set no-load voltage, 17-08=360V, lower the input voltage by 20V when operating in torque control.

Step 3: Set motor rated frequency:

$$17-04 = (\text{Rated frequency of motor nameplate}) \times \frac{(\text{Inverter input power voltage})}{(\text{Rated frequency of motor nameplate})} = 60\text{Hz} \times \frac{380\text{V}}{440\text{V}} = 51.8\text{Hz}$$

Step 4: Automatically tuning

Parameter 01-12 (Fbase) is automatically set during auto-tuning. Parameter 01-12 (Fbase) is set to the motor rated frequency.

Step 5: Set the 01-12 (Fbase) to the motor rated frequency on the motor nameplate. If the maximum output frequency (01-02, Fmax) and base frequency (01-12, Fbase) are different, set the maximum output frequency when the auto-tuning (01-02, Fmax) is completed.

When the inverter input voltage (or frequency) is higher than the motor rated voltage (or frequency), set the motor rated voltage (17-03) and the motor rated frequency (17-04) to the rated frequency on the motor nameplate.

Example 2: The inverter input voltage and frequency (460V/50Hz) are higher than the motor rated voltage and frequency (380V/33Hz), set 17-03 to 380V (rated motor voltage) and 17-04 to 33Hz (motor rated frequency).

- Number of poles (17-06)
Set the motor pole number with its range is 2, 4, 6, 8, 10, 12, 14 and 16 poles
- Number of PG pulse (17-07)
Set the pulse number of each cycle. If the control mode is SV mode and the V / F + PG mode, the encoder must be installed on the motor shaft and there is no reduction gear ratio.

- Motor no-load voltage (17-08)
 - a) Motor no-load voltage is mainly used in SV or SLV mode, set to value 10~50V lower than the input voltage to ensure good torque performance at the motor rated frequency.
 - b) Set to 85 ~ 95% of the motor rated voltage. In general, the no-load voltage can be closer to the motor rated voltage for larger motors, but cannot exceed the motor rated voltage.
 - c) The motor no-load voltage can be set to a value greater than the actual input voltage. In this case, the motor can only operate under relatively low frequency. If the motor operates at the rated frequency an over voltage condition may occur.
 - d) The higher the motor power is, the higher the no-load voltage is.
 - e) A smaller no-load voltage will reduce the no-load current.
 - f) When load is applied the magnetic flux is weakened and the motor current increases.
 - g) A higher no-load voltage results in a higher the no-load current.
 - h) When load is applied the magnetic flux weakens and the motor current increases. Increasing the magnetic flux generates back EMF and results in poor torque control.

- Motor excitation current (17-09)
 - a) Motor excitation current is used for rotational auto-tune.
 - b) Set motor excitation current to 30% of the motor rated current.
 - c) If this parameter is not set, the inverter will calculate the motor related parameters.
 - d) Only the static-type automatic tuning (17-00=1) can be set.

- Automatic tuning start (17-10)

Set parameter 17-10 to 1 and press ENTER the inverter will display "Atrdy" for Auto-tune ready. Next press RUN to start the auto-tune procedure. During auto-tune the keypad will display "Atune" for Auto-tune in progress. When the motor is successfully tuned, the keypad shows "AtEnd".

- Error history of automatic tuning (17-11)

If auto-tuning fails the keypad will display the "AtErr" message and the auto-tune cause is shown in parameter 17-11. Refer to section 5 for troubleshooting and possible automatic tuning error causes.

Note: The motor tuning error history (17-11) shows the tuning result of the last auto-tune. No error is displayed when auto-tune is aborted or when the last auto-tune was successful.

Perform the "Stator resistance measurement" (17-00=2) auto-tune if the inverter/motor leads are longer than 167ft (50m).

For the best performance in vector control perform the rotary-type automatic tune (17-00 = 0) first (using short motor leads between the inverter and motor) and a "Stator resistance measurement" (17-00=2) next.

If a rotary auto-tune (17-00=0) cannot be performed, manually enter the mutual induction (02-18), excitation current (02-09), core saturation compensation factor 1-3 (02-11 - 02-13).

Perform the "Stator resistance measurement" (17-00=2) in V/F control when inverter/motor leads are longer than 167ft (50m).

18-Slip Compensation Parameters

18-00	Slip compensation gain at low speed
Range	0.00~2.50
18-01	Slip compensation gain at high speed
Range	-1.00~1.00
18-02	Slip compensation limit
Range	0~250%
18-03	Slip compensation filter
Range	0.0~10.0 Sec
18-04	Regenerating slip compensation selection
Range	0: Disable 1: Enable
18-05	FOC delay time
Range	1~1000 msec
18-06	FOC gain
Range	0.00~2.00

Slip compensation automatically adjusts the output frequency based on the motor load to improve the speed accuracy of the motor mainly in V/F mode.

The slip compensation function compensates for the motor slip to match the actual motor speed to the reference frequency.

Slip compensation adjustment in V/F mode

18-00: Slip compensation gain at low speed

The adjustment of slip compensation gain at low speed follows the below procedure:

1. Set the rated slip and the motor no-load current (02-00).
2. Set the slip compensation (18-00) to 1.0 (factory default setting is 0.0 in V / F control mode)
3. For the operation with a load attached, measure the speed and adjust the slip gain (18-00) accordingly (increase in steps of 0.1).
 - If the motor speed is lower than frequency reference, increase the value of 18-00.
 - If the motor speed is higher than frequency reference, decrease the value of 18-00.

When the output current is greater than the no-load current (02-00), the slip compensation is enabled and the output frequency increases from f1 to f2. Refer to Figure 4.4.99., the slip compensation value is calculated as follows:

$$\text{Slip compensation value} = \text{Motor rated sync induction rotation difference} \times \frac{[\text{Output current (12-08)} - \text{motor no-load current (02-00)}]}{[\text{Motor output rated current (02-01)} - \text{motor no-load current (02-00)}]}$$

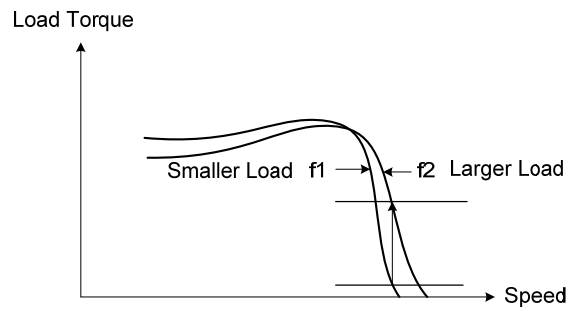

Figure 4.4.99 Slip compensation output frequency

18-02: Slip compensation limit

Sets slip compensation limit in constant torque and the constant power operation (figure 4.4.100). If 18-02 is 0%, the slip compensation limit is disabled.

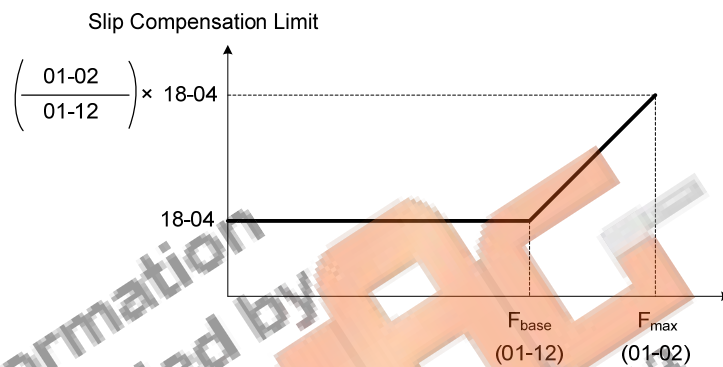

Figure 4.4.100 Slip compensation limit

When the slip compensation gain 18-00 at low speed is adjusted, and the actual motor speed is still lower than the reference frequency, the motor may be limited by the slip compensation limit.

Note: Make sure that the slip compensation limit 18-02 does not exceed the maximum allowed system limit.

18-03: Slip compensation filter

Set slip compensation filter time in V/F mode

18-04: Regenerating slip compensation selection

The selections to enable or disable the slip compensation function during regeneration.

To enable slip compensation during regeneration caused by deceleration (SLV mode), set 18-04 to 1 in case speed accuracy is required. When the slip compensation function is used regenerative energy might increase temporarily (18-04= 1) therefore a braking module might be required.

SLV mode adjustment

18-00: Slip compensation gain

- Slip compensation can be used to control the full range speed accuracy under load condition.
- If the speed is lower than 2 Hz and the motor speed decreases, increase the value of 18-00.
- If the speed is lower than 2 Hz and the motor speed increases, reduce the value of 18-00.

Slip compensation gain uses a single value for the whole speed range. As a result the slip compensation accuracy at low speed is high but slight inaccuracies might occur at high speeds.

Adjust parameter 18-02 together with the compensation value or continue to adjust 18-00 if the speed accuracy at higher speed is not acceptable. Please note adjusting these parameters might impact the accuracy at lower speeds.

The impact of 18-00 on the torque and the speed are shown in figure 4.4.101.

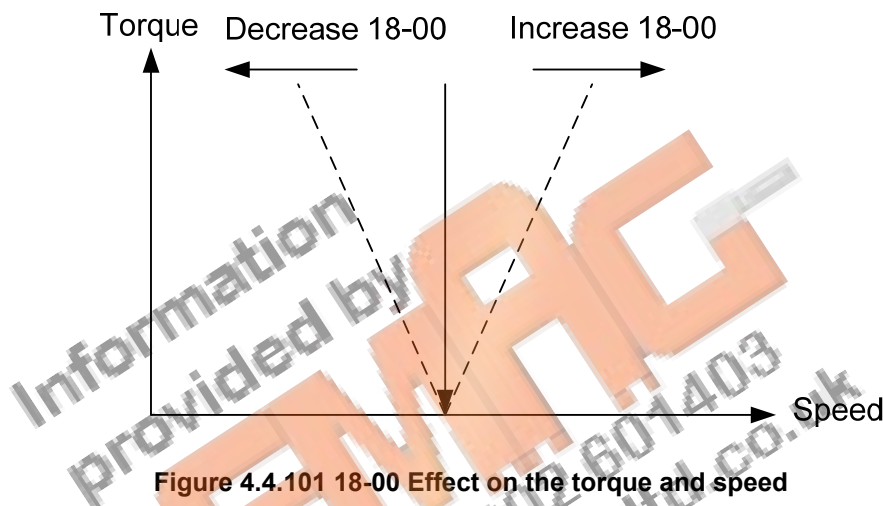

18-01: Slip compensation gain at high speed

It is not required to adjust the Slip compensation gain at high speed if the motor is loaded. After adjusting parameter 18-00 it is recommended to increase the reference frequency and check the motor speed. In case of a speed error increase the value of 18-01 to adjust the compensation. Increase the motor rated frequency (01-12 base frequency) and increase the value of 18-01 to reduce the speed error. If the speed accuracy becomes worse due to an increase in motor temperature it is recommended to use a combination of 18-00 and 18-01 for adjustment.

Compared to 18-00, 18-01 serves as a variable gain for the full speed range. Parameter 18-01 determines the slip compensation at the motor rated speed and is calculated follows:

$$\text{Slip compensation gain} = \text{Slip compensation gain at low speed} + \frac{[\text{Slip compensation gain at high speed} \times \text{frequency reference}]}{[\text{Motor rated frequency}]}$$

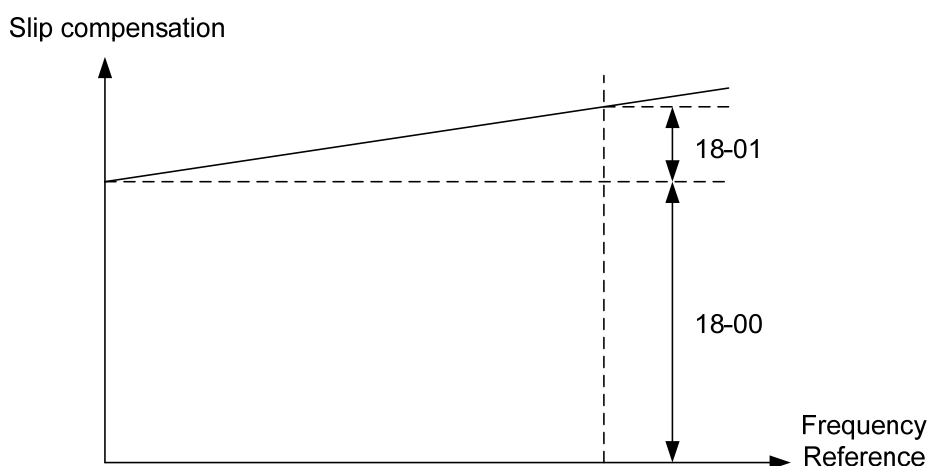

Figure 4.4.102 18-00/18-01 Slip compensation gain versus frequency reference

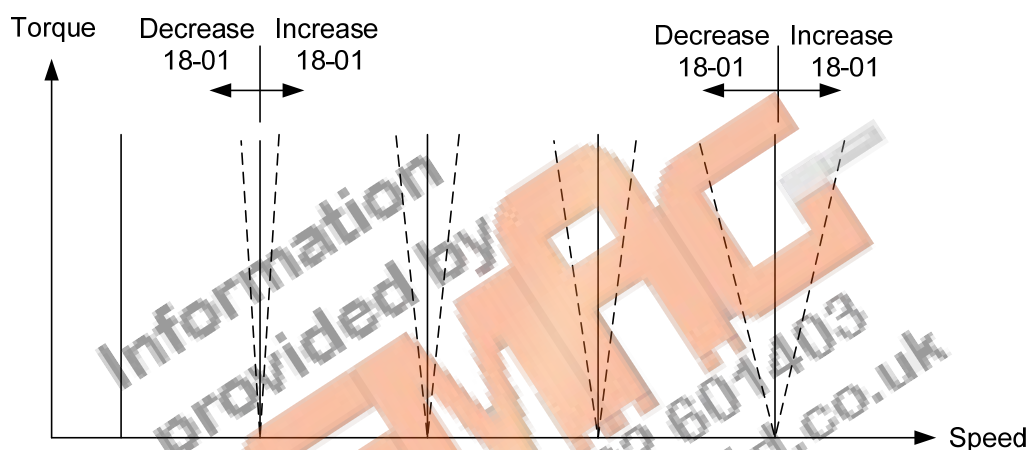

Figure 4.4.103 18-01 Effect on torque speed curve

18-05: FOC (Flux Orient Control) delay time

In the SLV mode, the slip compensation of the magnetic flux depends on the torque current and excitation current. If the motor load rises above 100% while running at the motor rated frequency, the motor voltage and resistance drops sharply, which may cause the inverter output to saturate and current jitter occur. The magnetic flux slip compensation will independently control the torque current and the excitation current to prevent current jitter. For slow speed or fixed speed operation, 18-05 may be increased. For fast operation adjust 18-06.

18-06: Slip compensation gain

If the motor is jittering at the rated frequency under full load, the value of 18-06 may gradually be reduced to zero to reduce current jitter.

19–Wobble Frequency Parameters

19-00	Center frequency of wobble frequency
Range	5.00~100.00%
19-01	Amplitude of wobble frequency
Range	0.1~20.0%
19-03	Jump time of wobble frequency
Range	0~50 msec
19-04	Wobble frequency cycle time
Range	0.0~1000.0 Sec
19-05	Wobble frequency ratio
Range	0.1~10.0 msec
19-06	Upper offset amplitude of wobble frequency
Range	0.0~20.0 %
19-07	Lower offset amplitude of wobble frequency
Range	0.0~20.0 %

Wobble operation can be used in V/F and V/F+PG control mode to modulate the output frequency around the reference frequency for use in winding application to create an evenly wound roll.

Refer to the figure 4.4.104 for the wobble operation and the related parameter settings.

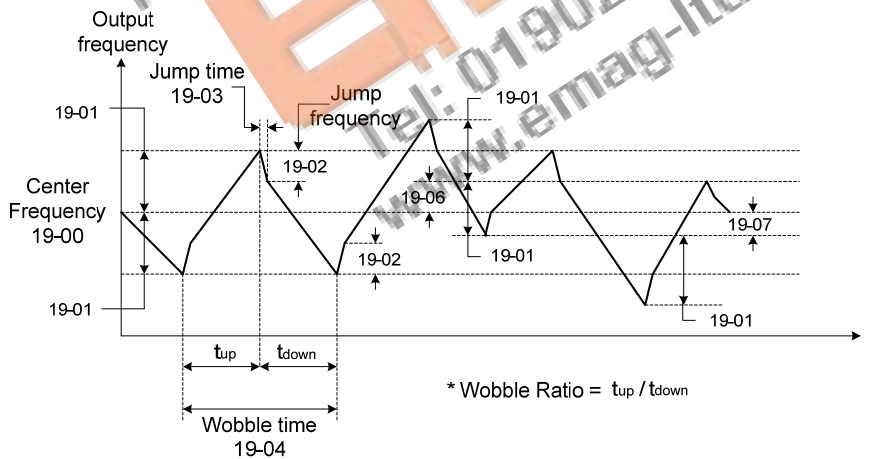

Figure 4.4.104 Wobble operation and the related parameter setting

In wobble operation, one of multifunction digital inputs (03-00 to 03-07) is set to 37 (wobble operation) and the run command is active. When the wobble operation is ready, the inverter output frequency reaches the center frequency (19-00). The acceleration time to the center frequency is the original pre-set acceleration time (Tacc 1 to Tacc 4). When the wobble operation is closed or the run command is removed, the deceleration time used is the original pre-set deceleration time (Tdec 1 to Tdec4).

In wobble operation, the inverter operates uses the in the wobble time (19-04, $t_{up} + t_{down}$) and wobble frequency (19-05, t_{up} / t_{down}).

Set multi-function digital output terminals (R1A-R1C, R2A-R2C) to output wobble operation (in acceleration) by setting from 03-11 to 03-12 to 20 or 21.

Refer to the figure 4.4.105 for the wobble ON / OFF control.

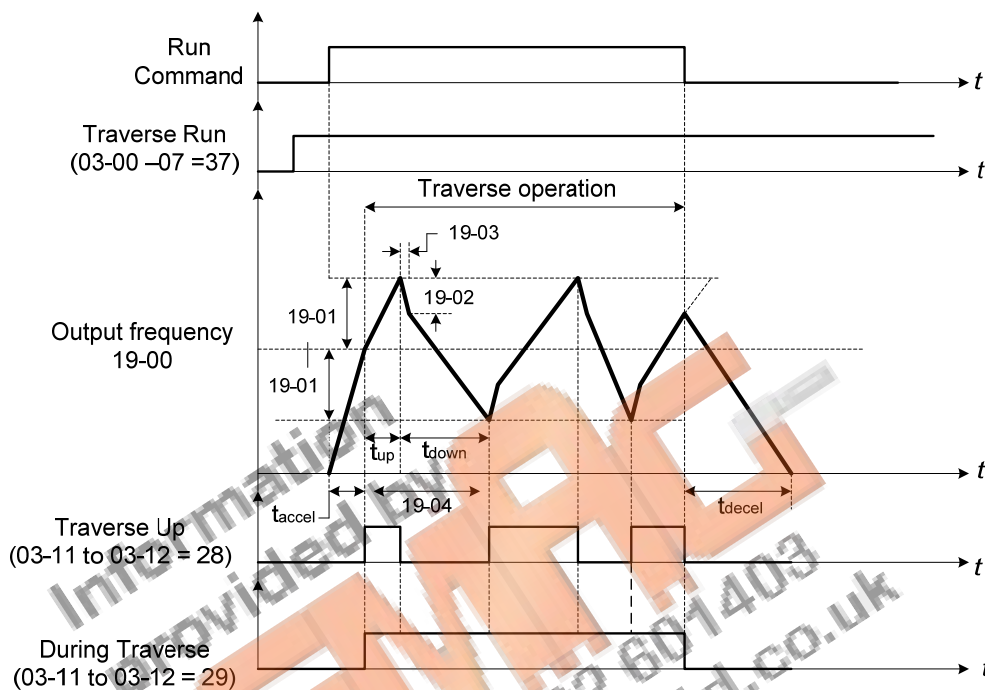

Figure 4.4.105 ON/OFF control of wobble

In wobble operation, the center frequency can be controlled by one of multi-function digital inputs.

The wobble upper and lower deviation command (03-00 to 07 = 38) and the wobble lower deviation command (03-00 to 07 = 39) cannot be active at the same time, this will result in the inverter operating at the original center frequency (19 - 00). Refer to Figure 4.4.106.

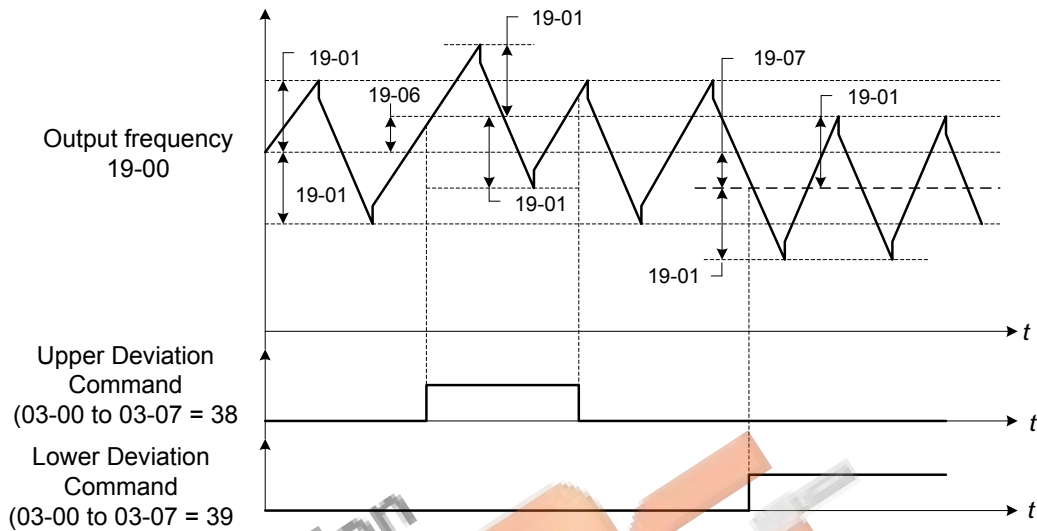

Figure 4.4.106 Upper/Lower offset operation

The wobble operation can be used during acceleration and deceleration when the stall prevention function is idle.

Select the appropriate inverter size to match the system requirement.

The wobble operation frequency range is determined by the upper limit and lower limit of the inverter frequency. If (center frequency + amplitude) is greater than the upper frequency limit, the output frequency is limited to the upper frequency limit; if (center frequency - Amplitude) is less than the lower frequency limit the output frequency is limited to the lower frequency limit.

20-Speed Control Parameters

20-00	ASR gain 1
Range	0.00~250.00
20-01	ASR integral time 1
Range	0.001~10.000 Sec
20-02	ASR gain 2
Range	0.00~250.00
20-03	ASR integral time 2
Range	0.001~10.000 Sec
20-04	ASR integral time limit
Range	0~300 %
20-05	ASR positive limit
Range	0.1 ~ 10 %
20-06	ASR negative limit
Range	0.1 ~ 1 %
20-07	Selection of acceleration and deceleration of P/PI
Range	<p>0: PI speed control will be enabled only in constant speed. For the speed acceleration and deceleration, only use P control.</p> <p>1: Speed control is enabled either in acceleration or deceleration.</p>
20-08	ASR delay time
Range	0.000~0.500 Sec
20-09	Speed Observer Proportional(P) Gain1
Range	0.00~2.55
20-10	Speed Observer Integral(I) Time 1
Range	0.01~10.00 Sec
20-11	Speed Observer Proportional(P) Gain2
Range	0.00~2.55
20-12	Speed Observer Integral(I) Time 2
Range	0.01~10.00 Sec
20-13	Low-pass filter Time constant of speed feedback 1
Range	1~1000 msec
20-14	Low-pass filter Time constant of speed feedback 2
Range	1~1000 msec

20-15	ASR gain change frequency 1
Range	0.0~400.0 Hz
20-16	ASR gain change frequency 2
Range	0.0~400.0 Hz
20-17	Torque compensation gain at low speed
Range	0.00~2.50
20-18	Torque compensation gain at high speed
Range	-10~10%

The following figure an overview of the automatic speed regulator (ASR) block.

V/F + PG control mode:

The ASR function adjusts the output frequency to control the motor speed to minimize the difference between the frequency reference and actual motor speed.

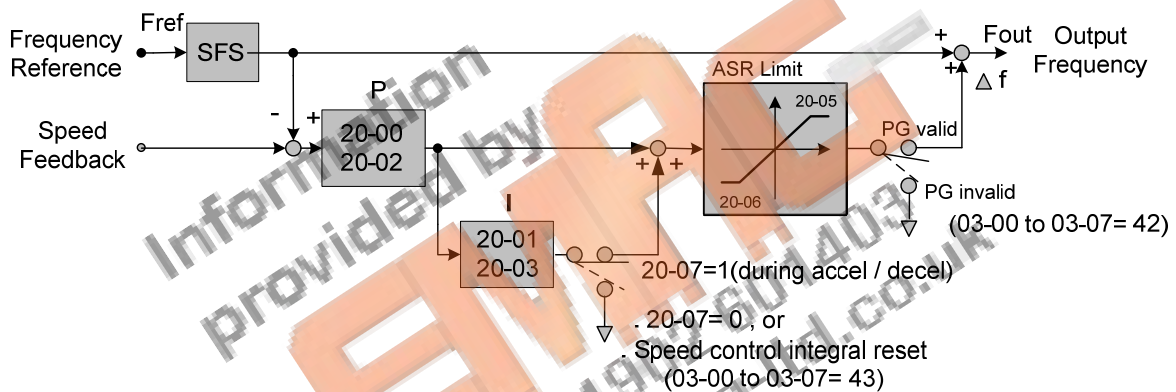

Figure 4.4.107 ASR block diagram (V/F + PG)

If one of the multi-function input (03-00 to 03-07) is set to 42 (PG is disabled), the input can be used to enable or disable the speed control loop system (ASR).

SLV control mode:

The ASR function adjusts the output frequency to control the motor speed to minimize the difference between the frequency reference and actual motor speed.

The ASR controller in SLV mode uses a speed estimator to estimate the motor speed. In order to reduce speed feedback interference, a low-pass filter and speed feedback compensator can be enabled.

The ASR integrator output can be disabled or limited. The ASR output is passed through a low-pass filter.

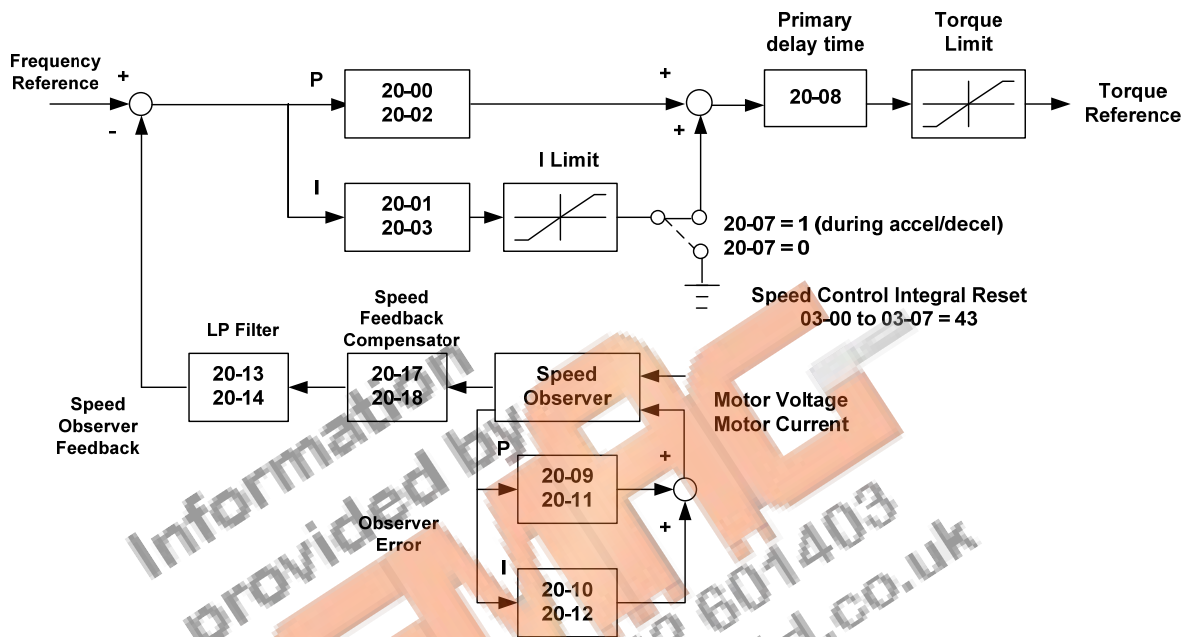

Figure 4.4.108 ASR block diagram (SLV mode)

SV control mode and PMSV mode:

The ASR function adjusts the output frequency to control the motor speed to minimize the difference between the frequency reference and actual motor speed.

The ASR controller in SLV mode uses a speed estimator to estimate the motor speed. In order to reduce speed feedback signal interference, a low-pass filter and speed feedback compensator can be enabled.

The ASR integrator output can be disabled or limited. The ASR output is passed through a low-pass filter.

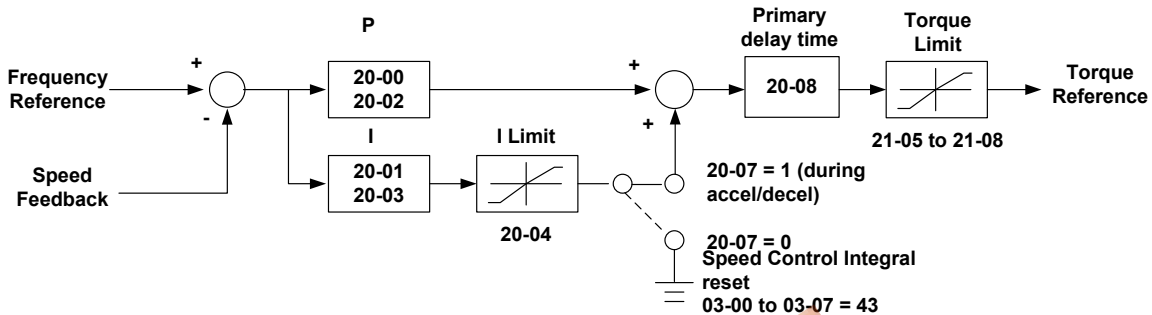

Figure 4.4.109 ASR block diagram (SV mode)

ASR setting in V/F +PG control mode

In V/F+PG mode, set the proportional (P) gain and integral (I) time at the minimum output frequency (20-02 and 20-03) and maximum output frequency (20-00 and 20-01). Refer to the figure 4.4.110.

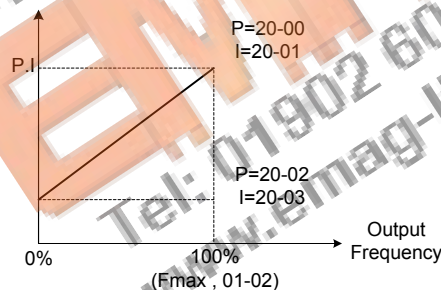

Figure 4.4.110 ASR gain setting (V/F+PG)

Tuning the speed control ASR gain:

a) ASR gain tuning at minimum output frequency

1. Operate the motor at the lowest output frequency.
2. Increase the ASR proportional gain 2 (20-02) as much as possible without causing instability.
3. Decrease the ASR integral time 2(20-03) as much as possible without causing instability.
4. Check that the output current is less than 50% of the inverter rated current.

If the output current is more than 50% of the inverter rated current, decrease 20-02 and increase 20-03.

b) ASR gain tuning at maximum output frequency

1. Operate the motor at the highest output frequency (Fmax).

2. Increase the ASR proportional gain 1 (20-00) as much as possible without causing instability.
3. Decrease the ASR integral time 1(20-01) as much as possible without causing instability.

c) The gain tuning of acceleration / deceleration integral control (20-07)

1. To enable during acceleration / deceleration operation set 20-07 = 1 (enabled), the integral control is enabled.
2. Integral control enables the motor speed to reach its target speed as soon as possible, but it may result in over or undershoot, as shown in Figure 4.4.113 & 4.4.114.
3. When one of multi-function digital inputs (03-00 to 03-07) is set to 43 (speed control integral reset), the input can be used to switch between P control and PI control of the speed control loop system (ASR). When the multi-function digital input is on, only P control is active and the integral is reset.
 - a. If the speed overshoot occurs, reduce 20-00 system (ASR proportional gain) and increase the 20-01 system (ASR integral time 1).
 - b. If the desired speed is not reached, reduce 20-02 system (ASR proportional gain 2) and increase 20-03 (ASR integral time 2).
 - c. If you cannot eliminate the speed over or undershoot using the gain tuning described above, decrease the ASR + / - limit (20-05 / 20-06), to decrease the reference frequency compensation (Δf) limit. Since 20-05/20-06 cannot be changed during running, it is necessary to stop the inverter first and then decrease the ASR + / - limit.
4. See figure 4.4.111, observe the motor speed waveform and tune the gain at the same time.

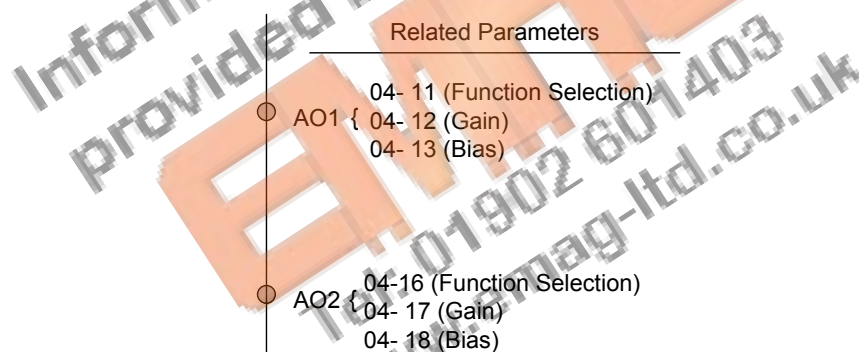

Figure 4.4.111 Analog output setting

d) ASR+/-limit (20-05, 20-06)

ASR +/-limit is ASR frequency compensation limit and is set as a percentage of the maximum frequency output 01-02.

Note: If the frequency limit is set too low, the actual motor speed may not reach the target speed.

ASR setting (SV/SLV/PMSV control mode)

In SLV mode the ASR gain is divided into a high-speed and low-speed section. The speed controller has a high-speed gain 20-00/20-01 and a low-speed gain 20-02/20-03 that can be set independently.

- The high/low switch frequency can be set with parameter 20-15 and 20-16. Similar to the ASR gain, the speed estimator has a high-speed gain 20-09/20-10 and a low-speed gain 20-11/20-12.
- The speed estimator has a low-pass filter to reduce the speed feedback interference, parameter 20-13 and 20-14 are active at high speed as well as low speed. The switch between the high-speed and the low-speed is set by parameter 20-15 and 20-16.
- 20-17 sets the low-speed compensation gain of the speed feedback.
- 20-18 sets the high-speed compensation gain of the speed feedback.
- When the frequency reference rises above the value set in 20-16, the ASR gain used is set by parameters 20-00 and 20-01.
- When the frequency reference falls below the value set in 20-15, the ASR gain used is set by parameters 20-02 and 20-03.
- Gain time constant is adjusted linearly when the speed command falls within the range of 20-15 to 20-16, for a smooth operation.

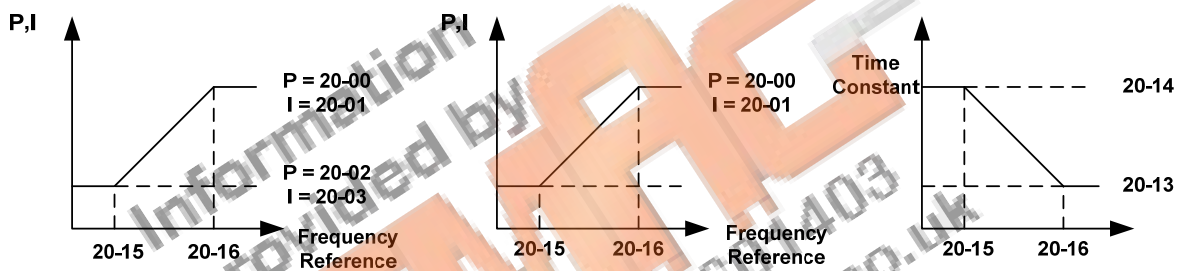

Figure 4.4.112 ASR gain setting (SLV mode)

SV and PMSV gain setting

In SV and PMSV mode the ASR gain is divided into a high-speed and low-speed section. The speed controller has a high-speed gain 20-00/20-01 and a low-speed gain 20-02/20-03 that can be set independently.

Tune the speed control gain

During ASR gain tuning, the multi-function analog output (AO1 and AO2 terminal) can be used to monitor the output frequency and motor speed (as shown in figure 4.4.112). Use parameters 20-00 ~ 20-03 for full speed range gain tuning in SV and PMSV mode.

- Complete the parameter tuning in normal operation.
- Increase ASR proportional gain 1 (20-00), ASR proportional gain 2 (20-02), carefully monitor system stability.

Use parameter 20-00 and 20-02 to adjust the speed response for each cycle. Tuning the settings of 20-00, 20-02 can increase system response, but may cause system instability. See figure 4.4.113.

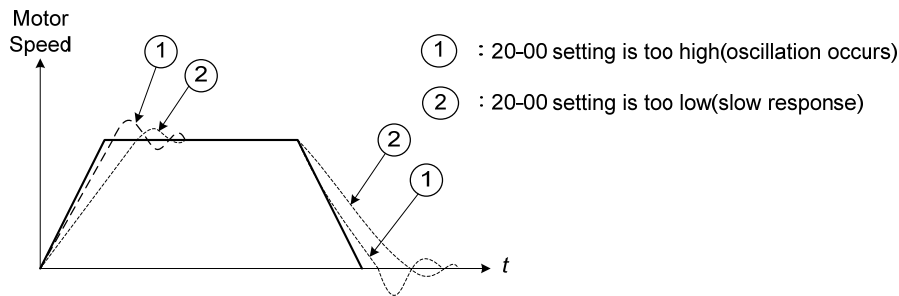

Figure 4.4.113 System response of ASR proportion gain

- a) Reduce ASR integral time 1(20-01), ASR integral time 2 (20-02) and carefully monitor system stability.
1. A long integral time will result in poor system response.
 2. If the integral time setting is too short, the system may become unstable Refer to the following figure.

While tuning ASR P and I gain the system may overshoot and an over voltage condition can occur. A braking unit (braking resistor) can be used to avoid an over voltage condition.

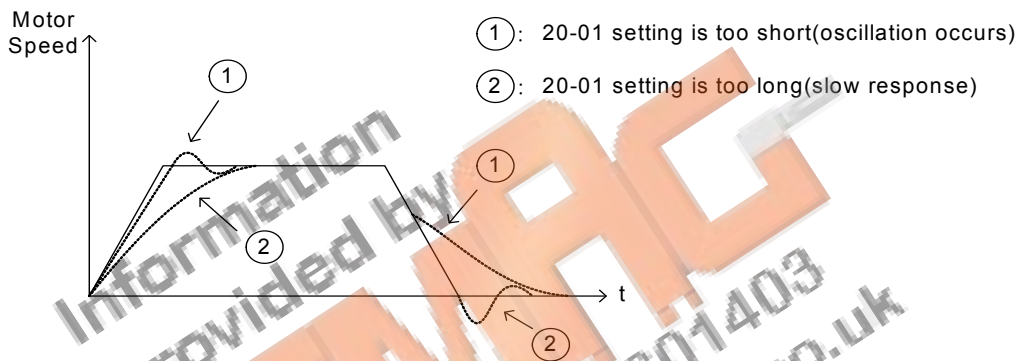

Figure 4.4.114 The response of ASR integral time

SLV mode gain tuning (20-00~20-03, 20-09~20-18)

Tune the low-speed ASR P and I gain 20-02 ~ 20-03, make sure the reference frequency is below parameter 20-15 value. P gain and integral time tuning is the same as for parameter 20-00 and 20-01 in SV mode.

Tune the high-speed ASR PI gain 20-00~20-01, make sure the reference frequency is above parameter 20-16 value. P gain and integral time tuning is the same as for parameter 20-00 and 20-01 under SV mode.

Both low-speed ASR gain and the high-speed gain can be set to the same values and only require to be adjusted in case of system instability.

In case tuning of the ASR P and I gain 20-00~20-03 does not improve the system response, reduce the low-pass filter time constant 20-13~20-14 to increase the bandwidth of the feedback system and re-tune the ASR gain.

- Tune low-speed low-pass filter time constant 20-14, make sure the reference frequency is below parameter 20-15 value
- Tune high-speed low-pass filter time constant 20-13 at frequency reference, make sure the reference frequency is above parameter 20-16 value.
- Increasing the low-pass filter time constant can limit the bandwidth of the speed feedback system and may

reduce the system response. Increasing the low-pass time reduces the speed feedback signal interference but may result in sluggish system response when the load suddenly changes. Adjust the low-pass filter time if the load stays fairly constant during normal operation. The low bandwidth of the speed feedback must be supported by the low gain of ASR to ensure the stable operation.

- Decreasing the low-pass filter time constant may increase the bandwidth of the speed feedback and the system response. Decreasing the low-pass time may increase the speed feedback interference resulting in system instability when the load suddenly changes. Decrease the low-pass filter time if a quick system response is required for rapidly changing loads. The high bandwidth of the speed feedback allows for a relative high ASR gain.
- In case tuning 20-00 ~ 20-03 and the low-pass filter time constant 20-13 do not improve the system response time, tuning the PI gain 20-09 ~ 20-12 of the speed estimator may be required.
- Setting a high gain for the speed estimator (high proportion (P) gain and small integral (I) time) increases the bandwidth of the speed feedback, but may cause speed feedback interference resulting in system instability.
- Setting a low gain for the speed estimator (small proportion (P) gain and high integral (I) time) decreases the bandwidth of the speed feedback, may improve speed feedback interference resulting in a more stable system.
- The default values for the ASR can be used in most applications, no adjustment is required. Adjusting the low-pass filter time and speed estimator gains requires a good understanding of the overall system. If a high-speed system response in combination with stable operation is required consider using SLV or SV control mode.
- Parameter 20-15 sets the gain switch frequency at low-speed and parameter 20-16 sets the gain switch frequency at high-speed.
- Operating at a speed below 20-15 will result in a larger excitation current for low-speed operation accuracy. When the frequency reference rises above 20-16, the inverter will output the rated excitation current at the no-load voltage (02-19).
- For general purpose applications parameter 20-15 should be set to a value of 5 ~ 50% of the motor base frequency.
- If this value is too high, the inverter output may saturate. Parameter 20-16 should be set to a value of 4Hz or more above the value of 20-08.
- When experiencing speed jitter at high speed and stable operation during mid-range speed while operating a heavy load (>100%), it is recommended to reduce the no-load voltage (02-19) or tune the FOC parameters (18-05 ~ 18-06).
- Parameter 20-17 and 20-18 are for compensating speed feedback at low speed and high speed.

- Use parameter 20-17 to adjust the torque compensation gain for the low speed range. By tuning 20-17 an offset is added to the torque-speed curve. Increase 20-17 when the no-load speed is lower than the frequency reference. Decrease 20-17 when the no-load speed is higher than the frequency reference. The effect on the torque-speed curve from 20-17 is shown as the following figure:

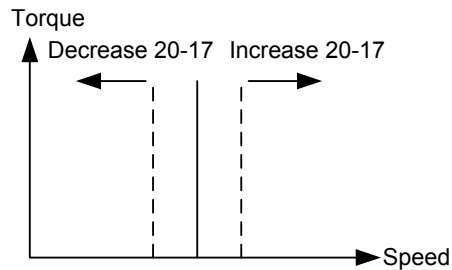

Figure 4.4.115 Effect on the torque-speed curve from 20-17

- Use parameter 20-18 to adjust the torque compensation gain for middle to high speed range. For most general purpose applications it is not necessary to adjust the 20-18. By tuning 20-18 an offset is added to the torque-speed curve. Increase 20-18 when the no-load speed is lower than the frequency reference. Decrease 20-18 when the no-load speed is higher than the frequency reference. The effect on the torque-speed curve from 20-18 is shown as the following figure 4.4.116.

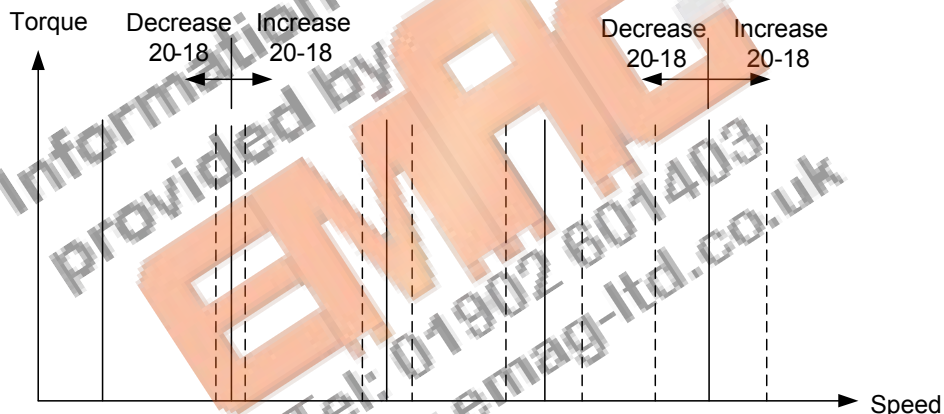

Figure 4.4.116 Effect on the torque-speed curve from 20-17

- ① ASR main delay time (20-08).
 - a) Does not required to be adjusted for general purpose applications
 - b) When the set value of 20-08 is set high, the speed response will and therefore system response will decrease improving system stability.
- ② ASR integral limit (20-04)
 - a) Setting a small value may prevent system response when the load suddenly changes.

20-19	Overspeed (OS) selection
Range	0: Deceleration to stop 1: Coast to stop 2: Continue to operate
20-20	Overspeed (OS) detection level
Range	0~120 %
20-21	Overspeed (OS) detection time
Range	0.0~2.0 sec
20-22	Speed deviation (DEV) selection
Range	0: Deceleration to stop 1: Coast to stop 2: Continue to operate
20-23	Speed deviation (DEV) detection level
Range	0~50 %
20-24	Speed deviation (DEV) detection time
Range	0.0~10.0 sec
20-25	Selection of PG Open
Range	0: Deceleration to stop 1: Coast to stop 2: Continue to operate
20-26	Detection time of PG Open
Range	0.0~10.0 Sec
20-27	PG pulse number
Range	0~60000 ppr
20-28	Selection of PG rotation direction
Range	0: Forward as counter-clockwise rotation 1: Forward as clockwise rotation
20-29	PG pulse dividing ratio
Range	001~132
20-30	PG gear ratio 1
Range	1~1000
20-31	PG gear ratio 2
Range	1~1000

- PG card is required (PG-X3/PG-B3/PG-IPM)
PG pulse divider ratio can be set parameter 20-29.

- PG feedback setting

(1) Over speed operation setting (20-19 to 20-21)

- a) When the motor speed exceeds the tuning limit, an error is detected.
If the motor speed feedback exceeds the value of 20-20 (overspeed detection level) for the time specified in 20-12 (over speed detection delay time) an over-speed (OS) condition is detected.
- b) Overspeed detection selection (20-19) specifies the stop method for the inverter in case of an overspeed condition.

(2) PG Speed deviation setting (20-22 to 20-24)

- a) When the speed deviation (difference between the set speed and the actual motor speed) exceeds the tuning limit, an error is detected.
- b) If the speed deviation is greater than the value of 20-23 (deviation detection level) for the time specified in 20-24 (deviation detection delay time), a speed deviation (DEV) is detected.
- c) Speed deviation is based on the reference frequency \pm speed deviation width, parameter 20-23.
- d) Speed deviation detection selection (20-22) specifies the stop method for the inverter in case of a speed deviation condition.

(3) PG detection setting (20-25 to 20-26)

- a) When the inverter no longer received pulses fro, the PG feedback for the time specified in 20-26 a PG open condition is detected.
- b) PG open detection selection (20-25) specifies the stop method for the inverter in case of a PG open condition.

Refer to figure 4.4.117 for the PG fault detection block diagram.

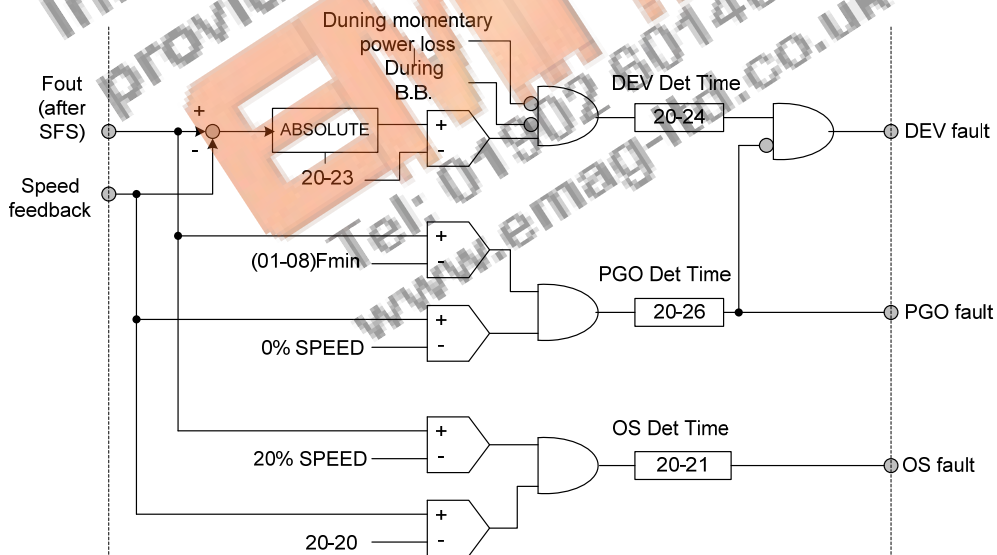

Figure 4.4.117 Logic diagram PG feedback failure detection

(4) Set PG pulse (20-27)

- a) Set PG of pulse number of the encoder for phase A or phase B for each cycle
- b) If a gearbox is used between the motor and PG the gear ratio can be set with parameter 20-30 and 20-31.

(5) PG rotation direction (20-28)

Parameter is used to set the motor direction and PG direction. Make sure phase A or phase B is leading for motor forward direction operation.

20-28=0: Forward operation, phase A is leading (phase B is leading for reversal operation).

20-28=1: Forward operation, phase B is leading (phase A is leading for reversal operation).

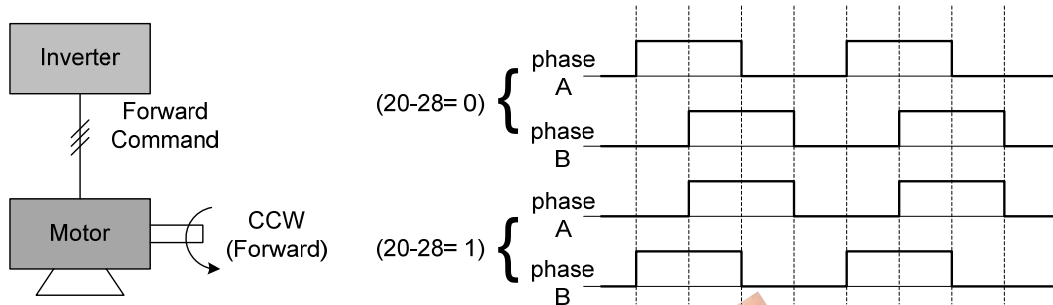

Figure 4.4.118 PG and motor rotation direction

Motor direction is determined as below:

Forward: The motor direction is counter-clockwise when inverter runs in forward direction (see figure 4.4.119.)

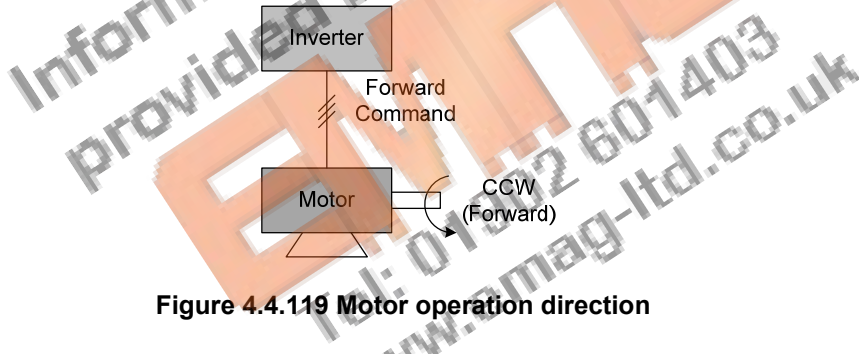

Figure 4.4.119 Motor operation direction

Forward: The motor direction is clockwise when inverter runs in forward direction (see figure 4.4.120.)

Refer to the below figure 4.4.120 for PG feedback pulses.

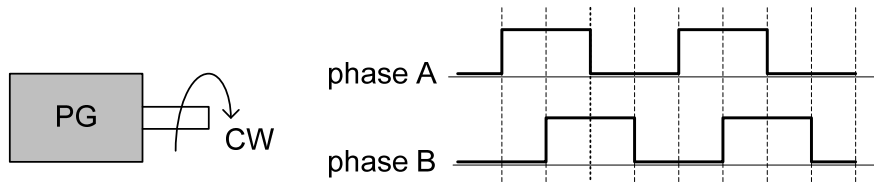

Figure 4.4.120 PG operation direction

(6) PG pulse dividing ratio (20-29)

Sets the pulse divider ratio between the PG input and PG output.

The left most digit (3rd) represent the numerator and the last to represent the denominator.

Ratio is calculated as follows:

$$20-29 = \square \square \square, = \underline{n} \underline{kk}$$

Range n: 0 to 1

Range k: 1 to 32

$$\text{Ratio} = (1+n)/k$$

Examples:

$$20-29=001 \rightarrow n=0, k=1, \text{proportion} = (1+0)/1=1$$

$$20-29=032 \rightarrow n=0, k=32, \text{proportion} = (1+0)/32=1/32$$

$$20-29=132 \rightarrow n=1, k=32, \text{proportion} = (1+1)/32=1/16$$

(7) Gear ratio of PG and motor (20-30, 20-31).

Gear ratio specifies when a gearbox is connected between the PG and the motor

- a) Set the gear ratio of the load side parameter 20-31.
- b) Set the gear ratio of the motor side parameter 20-30.

Motor speed is calculated as follows:

$$\text{Motor Speed(RPM)} = \frac{\text{No. of input pulses from PG} \times 60}{\text{PG pulses (20-27)}} \times \frac{\text{No. of PG gear teeth 2 (20-31)}}{\text{No. of PG gear teeth 1 (20-30)}}$$

Note: The response speed in V / F + PG mode is less than that of SV mode.

20-32	Special encoder selection
Range	0: None 1: Resolver 2: SIN/COS encoder

Select encoder type. Power to the inverter needs to be cycled for changes to take effect.

21-Torque And Position Control Parameters

21-00	Torque control selection
Range	0: Speed control 1: Torque control

21-01	Filter time of torque reference
Range	0~1000 msec

21-02	Speed limit selection
Range	0: according AI input 1: according to the set value of 21-03

21-03	Speed limit value
Range	-120~120 %

21-04	Speed limit bias
Range	0~120 %

21-00: Torque control selection
Select between speed control and torque control in SV mode.

21-00= 0: Speed control (20-00, 20-09), ASR setting
21-00= 1: Torque control (21-01 to 4), torque control setting

A multi-function digital input terminal (03-00 to 03-08) set to 44 (speed / torque control switching) can be used to switch between speed and torque mode externally. When the input terminal is active torque control is selected otherwise speed control is selected.

Refer to figure 4.4.108 for the speed control architecture and figure 4.4.121 for torque control architecture.

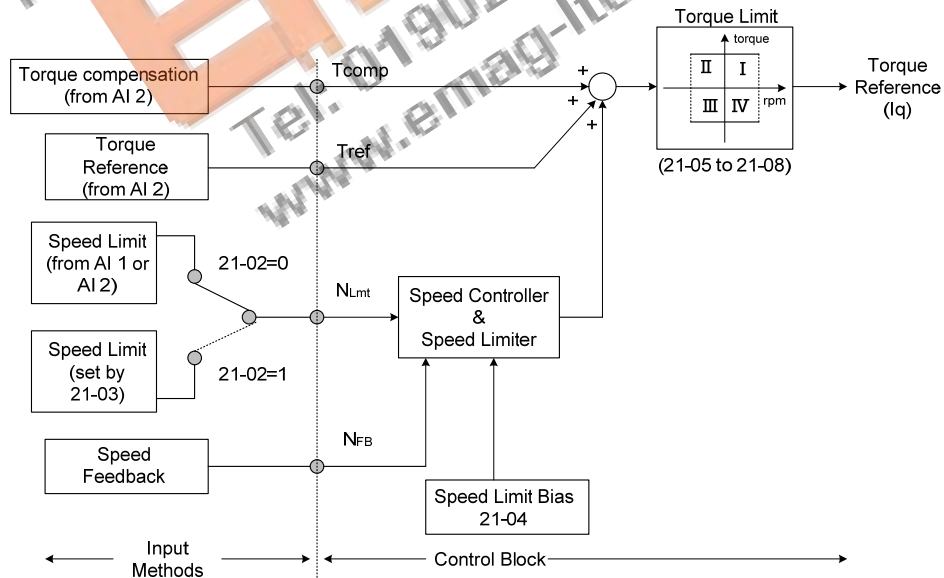

Figure 4.4.121 Block figure of the torque control

Torque Control

The torque reference command (Tref) uses analog input AI2 (04-05=15)

Note: Torque reference command cannot be set via the keypad.

Multi-function analog input (AI2) can used for torque reference (04-05=15) (torque) or torque compensation level (04-05=16).

The direction (torque output) of the motor depends on the polarity of the analog input signal (AI2) instead of the direction of the run command.

Analog input AI2: Positive voltage forward torque reference (Motor direction counter clockwise).

Analog input AI2: Negative voltage reverse torque reference (Motor direction clockwise).

To switch to a negative torque reference set one of the multi-function digital input (03-00 to 03-07) to 45 (negative torque command), and activate the digital input terminal (Motor direction clockwise).

Table 4.4.16 Torque input method

Input	Input terminal	Parameter setting	Description
Voltage input (0 -10V)	AI2 (SW1-2=" V ")	04-00=0,2	Terminal AI2 signal level: 0 - 10V
		04-05=15	AI2 used as for torque reference
Current input (4 - 20mA)	AI2 (SW1-2=" I ")	04-00=1,3	Terminal AI2 signal level: 4 - 20mA
		04-05=15	AI2 used as for torque reference

21-01: Torque filter time

Time constant used to reduce the torque signal interference and adjust the torque response. Increase filter time in case the system becomes unstable.

21-02/21-03: Speed limit input setting

Limits the motor speed while operating in torque control. When the external torque reference and the system load are out of balance the speed limit may be used to prevent the motor from damaging the system.

The speed limit can be set via the digital inputs or using an analog input signal to set the speed limit level. Refer to the table 4.4.17 for the speed limit input method.

Table 4.4.17 Speed limit input method

Input method	Input terminal	Related parameter setting	Description	
1	Voltage input (-10V – 10V)	AI1	21-02=0	Analog input (AI1 or AI2) as speed limit
			00-05=1	Analog input (AI1 or AI2 is set by 04-05) as reference frequency input
			04-00=2,3	Terminal AI1 signal level : -10V - 10V (if the speed limit is plus value, set 04-00=0, 1)
	Voltage input (10V - 10V)	AI2 (SW2=" V ")	21-02=0	Analog input (AI1 or AI2) as speed limit
			00-05=1	Analog input (AI1 or AI2 is set by 04-05) as reference frequency input
			04-00=0,2	Terminal AI2 signal level : 0V - 10V
	Current input (4 - 20mA)	AI2 (SW2=" I ")	04-05=12	AI2 will be added to terminal AI1 as speed limit value
			21-02=0	Analog input (AI1 or AI2) as speed limit
			00-05=1	Analog input (AI1 or AI2 is set by 04-05) as reference frequency input
			04-00=1,3	Terminal AI2 signal level : 4 – 20mA
			04-05=12	AI2will be added to terminal AI1 as speed limit value
			21-02=1	Set the speed limit to be controlled by 21-03
2	Parameter 21-03 setting	21-03	Set speed limit	

The rotation direction in speed control depends on the speed limit signal:

- Positive voltage: Forward, speed limit (21-03 + 21-04).
- Reverse speed limit is forward or reversal direction (-21-04).
- Negative voltage: Reverse, speed limit (-21-03-21-04).
- Forward, speed limit is zero or forward direction (21-04).

If the speed limit bias is set to 0, the motor speed will be limited to 0 when the rotation direction of the motor and the speed limit are in reverse.

Example: The speed limit analog signal is a positive voltage and the motor is in forward operation, then the effective speed range in torque control is from 0 to the analog speed limit value.

21-04: Speed limit bias setting

Speed limit bias (21-04) is used to adjust the boundaries of the speed limit. The speed limit bias (21-04) can be used to set the same limit value in forward and reversal direction and is set as a percentage of the maximum output frequency (01-02).

Example 1: Set 30% speed limit in forward and reverse direction.

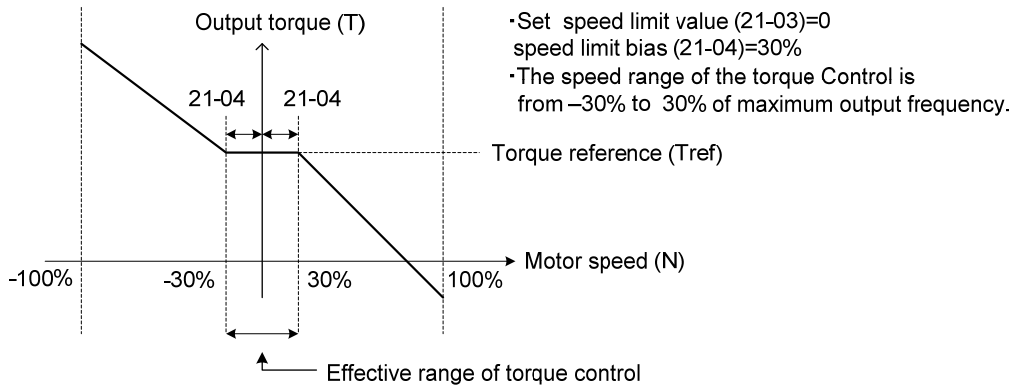

Figure 4.4.122 Speed limit setting

Example 2:

- Settings: 1. Speed limit value (21-03) =100% (positive speed limit)
 2. Speed limit bias (21-04) = 20%

The speed range in torque control is from -20% (21-04) to 120% (21-03+21-04)

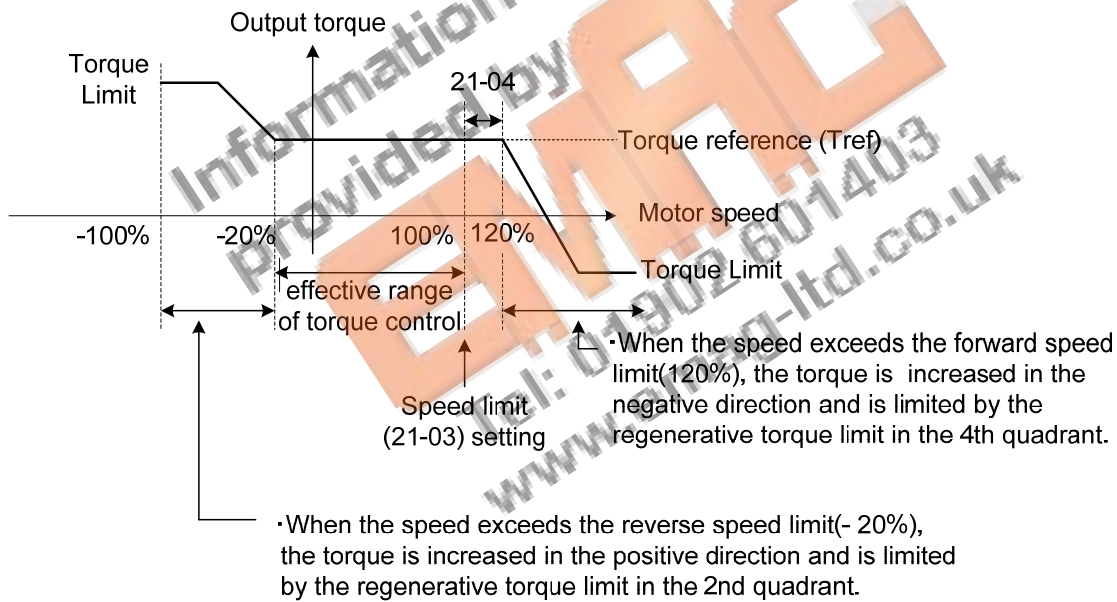

Figure 4.4.123 Speed limit setting (Example 2)

Example: Torque limit and speed limit operation:

In this example the torque limit and speed limit are used in a winding and unwind operation.

Winding operation

The line speed (N) and motor torque (T) are in the same direction of the motor. Refer to Figure 4.4.124

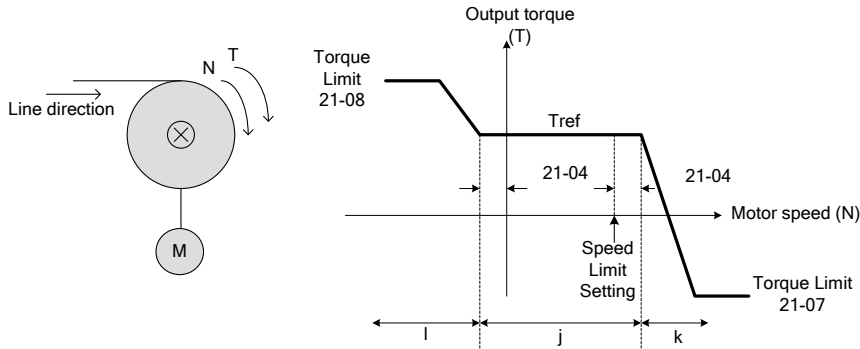

Figure 4.4.124 Winding operation

- ①. Speed limit bias (-21-04) > Motor Speed > speed limit bias (+21-04) → torque based on Tref.
- ②. Motor speed (N) > speed limit bias +21-04 → speed limit will output negative torque to prevent the increase of motor speed.
- ③. Motor speed (N) < -21-04 → speed limit will output a forward torque to prevent an increase of speed.

Unwinding operation

The line speed (N) and motor torque (T) are in opposite direction

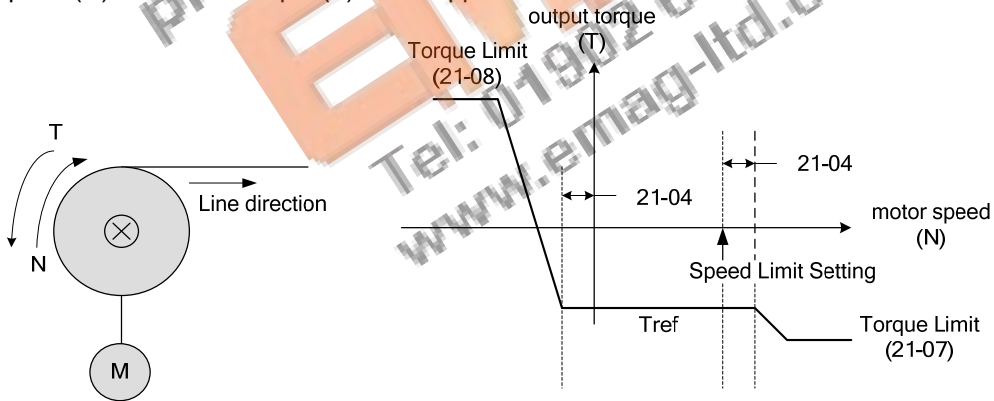

Figure 4.4.125 Unwind operation

The relationship among Tref (torque reference), NLmt (speed limit) and N (motor speed) is shown below when used in winding operation and roll-out operation.

Operations	Winding operation		Unwind operation	
T-N curve				
Operation direction	Forward	Forward	Forward	Forward
Tref (Torque reference)	+	-	-	+
N _{Lmt} (Speed limit)	+	-	+	-
Architecture				

Figure 4.4.126 Winding and roll-out operations

Torque compensation

Torque compensation is used to compensate for torque loss due to mechanical damage or other losses. Multi-function analog input AI2 can be used for torque compensation (04-05 = 16, 04-07/08 Gain/ Bias).

Set the appropriate signal level for the torque compensation. The torque compensation direction is based on the analog signal polarity, not by the direction of the run command.

When Tcomp is fixed at a positive voltage (or current) results in a positive torque compensation (the rotation of motor shaft is counterclockwise).

21-05	Positive torque limit
Range	0~300 %
21-06	Negative torque limit
Range	0~300 %
21-07	Forward regenerating torque limit
Range	0~300 %
21-08	Reversal regenerating torque limit
Range	0~300 %

Use the torque limit function to limit the torque applied to the load, or limit the regenerative torque.

In speed control the torque limit function has a higher priority than the motor speed control and compensation. This might result in extended acceleration, deceleration times and a reduction in motor speed.

Torque limit can be set in two ways:

- Use torque limit parameters (21-05 to 21-08) to set a fixed torque limit.
- Set the torque limit by using the multi-function analog input (AI2).

There are four torque limits that can be set separately, one for each quadrant:

- (I) Positive torque limit in forward direction (21-05 positive torque limit)
- (II) Positive torque limit of reverse direction (21-06 negative torque limit)
- (III) Negative torque limit in reverse direction (21-07 forward regenerating torque limit)
- (IV) Negative torque limit in forward direction (21-08 reversal regenerating torque limit)

Refer to Figure 4.4.127.

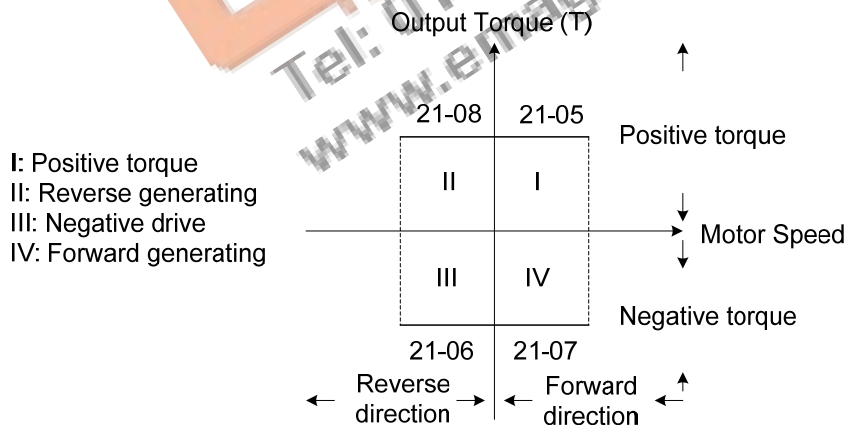

Figure 4.4.127 Torque limit setting

Torque limit setting by using multi-function analog input AI2 (04-05)

Table 4.4.18 Torque limit analog input

04-05 (AI2)	Function
11	Positive torque limit
12	Negative torque limit
13	Regenerative torque limit (for both forward and reversal directions).
14	Positive/negative torque limit (positive and negative detection torque limit)

Set the analog input terminal (AI2) signal level (04-00), gain (04-07) and bias (04-08)

The default setting for the analog input AI2 is 0 -10V representing 0 – 100% of the motor rated torque).

Figure 4.4.128 shows the relationship between the output torque and the torque limit.

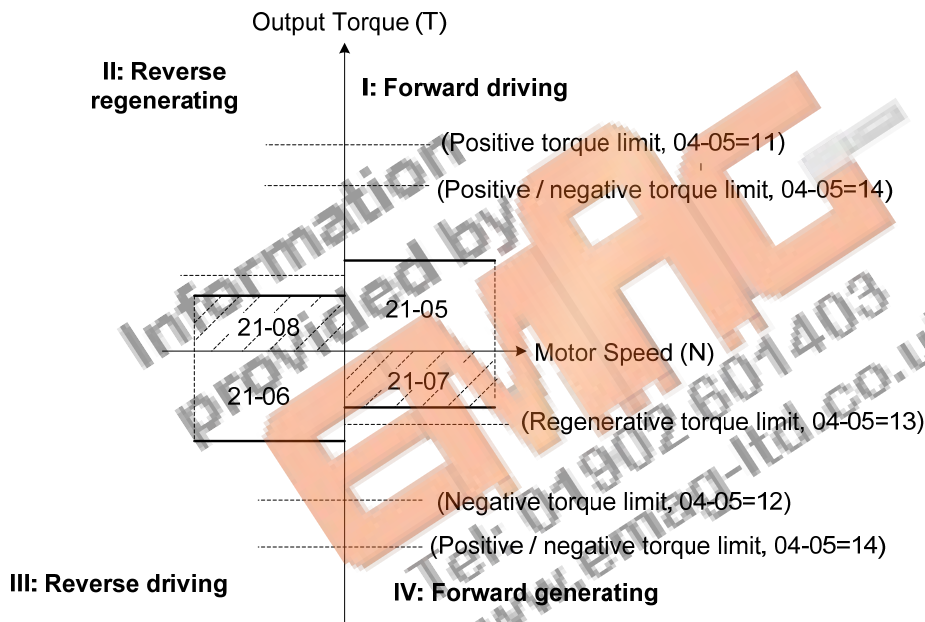

Figure 4.4.128 Analog input torque limit (AI2)

When the analog input is set to positive torque limit (value = 11) the torque limit is active in the third and fourth quadrant.in the reverse direction (regenerative torque in the second quadrant).

When the analog input is set to negative torque limit (value = 12) the torque limit is active in the third and fourth quadrant.

When the analog input is set to regenerative torque limit (value = 13) the torque limit is active in the second and fourth quadrant can be controlled.

When the analog input is set to positive/negative torque limit (value = 14) the torque limit is active in all four quadrants.

When the analog input is at maximum (10V or 20mA), the torque limit is 100% of the motor rated torque. In order

to increase the torque limit above 100% the analog input gain (04-07) has to set to a value greater than 100%. For example: 200.0% of the gain will result in the torque limit of 200% of motor rated torque at 10V (20mA) analog input level.

21-09	Maximum frequency of position control
Range	0.1~100 Hz
21-10	The command of rotation cycle number of section 0
Range	-9999~9999
21-11	The command of the pulse number of section 0
Range	-9999~9999
21-12	The command of rotation cycle number of section 1
Range	-9999~9999
21-13	The command of the pulse number of section 1
Range	-9999~9999
21-14	The command of rotation cycle number of section 2
Range	-9999~9999
21-15	The command of the pulse number of section 2
Range	-9999~9999
21-16	The command of rotation cycle number of section 3
Range	-9999~9999
21-17	The command of the pulse number of section 3
Range	-9999~9999
21-18	The command of rotation cycle number of section 4
Range	-9999~9999
21-19	The command of the pulse number of section 4
Range	-9999~9999
21-20	The command of rotation cycle number of section 5
Range	-9999~9999
21-21	The command of the pulse number of section 5
Range	-9999~9999
21-22	The command of rotation cycle number of section 6
Range	-9999~9999
21-23	The command of the pulse number of section 6
Range	-9999~9999
21-24	The command of rotation cycle number of section 7
Range	-9999~9999
21-25	The command of the pulse number of section 7
Range	-9999~9999

21-26	The command of rotation cycle number of section 8
Range	-9999~9999
21-27	The command of the pulse number of section 8
Range	-9999~9999
21-28	The command of rotation cycle number of section 9
Range	-9999~9999
21-29	The command of the pulse number of section 9
Range	-9999~9999
21-30	The command of rotation cycle number of section 10
Range	-9999~9999
21-31	The command of the pulse number of section 10
Range	-9999~9999
21-32	The command of rotation cycle number of section 11
Range	-9999~9999
21-33	The command of the pulse number of section 11
Range	-9999~9999
21-34	The command of rotation cycle number of section 12
Range	-9999~9999
21-35	The command of the pulse number of section 12
Range	-9999~9999
21-36	The command of rotation cycle number of section 13
Range	-9999~9999
21-37	The command of the pulse number of section 13
Range	-9999~9999
21-38	The command of rotation cycle number of section 14
Range	-9999~9999
21-39	The command of the pulse number of section 14
Range	-9999~9999
21-40	The command of rotation cycle number of section 15
Range	-9999~9999
21-41	The command of the pulse number of section 15
Range	-9999~9999

21-09 Maximum frequency for position control

Maximum output frequency when moving to the next position. The position control function uses deceleration time 1 (00-15).

In the SV control mode, multi-function digital input terminals (03-00 to 03-07) can be used to select the position. See table 4.4.19.

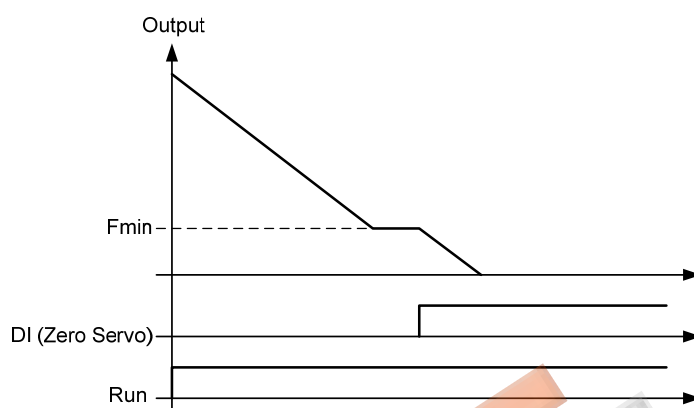

Figure 4.3.129 Zero-servo positioning

Multi-position function (MultiPosRef):

Table 4.4.19 Multi-position positioning function setting

Digital Input setting 03-00~03-07	Function
02	Multi-speed/position setting command 1
03	Multi-speed/position setting command 2
04	Multi-speed/position setting command 3
05	Multi-speed/position setting command 4
46	Zero-Servo command
51	Select between speed control and position control
52	Position command enable

Zero-servo positioning function (Zero-Srvo):

When the output frequency falls below F_{min} and the zero-servo input is active, the position is locked in and the inverter enters zero-servo positioning mode (Zero-Srvo). Positioning command PosRef is origin, as shown in figure 4.4.129.

Refer to parameter 11-49 and 11-50 for zero-servo gain and zero-servo count and parameter 20-02 and 20-03 to setup the speed regulator function.

Position control:

- Activate Run command (RUN)
- Activate Zero-Servo command (Zero-Srvo)
- Activate Position enable command (MultiPosEn)
- Select a position with the multi-function digital inputs (PosRef)

Refer to figure 4.4.130.

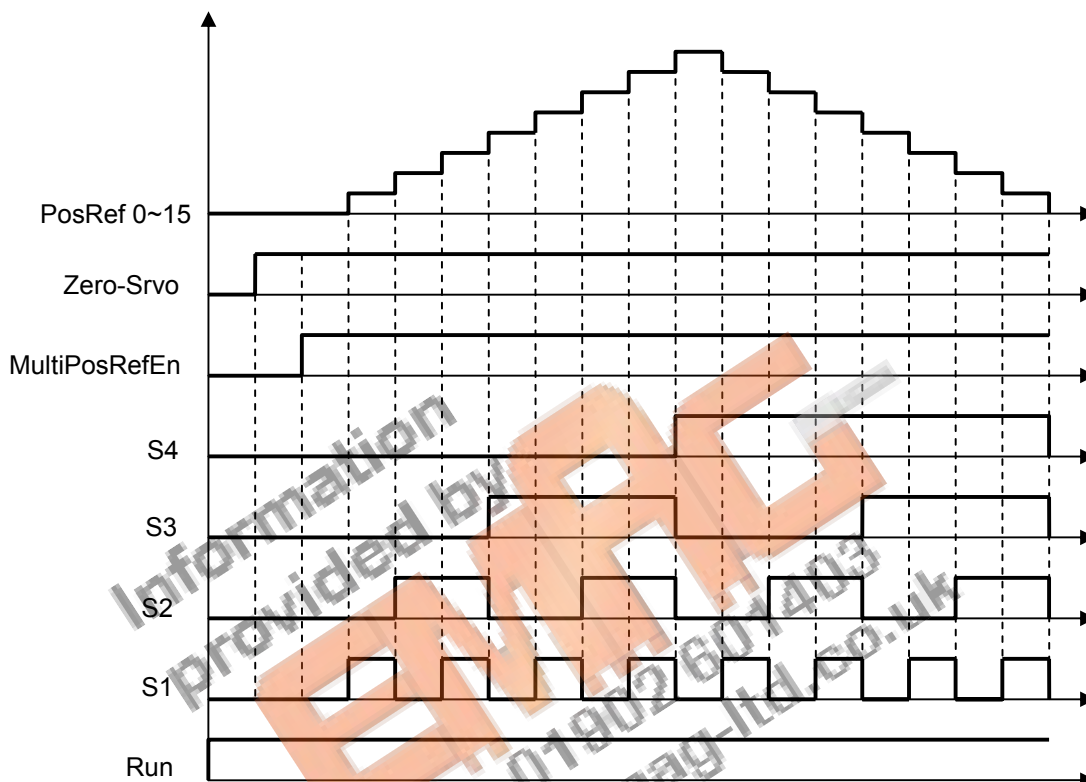

Figure 4.4.130 Multi-positioning logic diagram

Refer to parameter 20-28 to set PG motor direction.

A position is defined by the number of rotations plus the number of pulses.

Example: 2 Positions

Motor encoder is 1024 PPR.

Position 1: Rotate motor shaft in forward direction 180 degrees, set rotation cycle to 0 and pulse number to 512 (1/2 x 1024). Positive number indicated forward direction.

Position 2: Rotate motor shaft 1reverse 270 degrees (-768 pulses), set rotation cycle to 0 and pulse number to -768 (- 3/4 x 1024). Negative number indicated forward direction.

22- PM Motor Parameters

22-00	PM motor rated power
Range	0.00~600.00 Kw
22-01	PM motor rated voltage
Range	50~240 V: 200V 100~480 V: 400V
22-02	PM motor rated current
Range	25%~200% inverter's rated current
22-03	PM motor's pole number
Range	2~96 Poles
22-04	PM Motor's rated rotation speed
Range	0~60000 rpm
22-05	PM motor's maximum rotation speed
Range	0~60000 rpm
22-06	PM motor rated frequency
Range	0.0~400.0 Hz

The PM parameter group can be restored to factory default by initializing the inverter (13-00).

- (01) PM motor rated power (22-00)
Set the motor power according to the motor nameplate.
- (02) PM motor rated voltage (22-01)
Set the motor voltage according to the motor nameplate.
- (03) PM motor rated current (22-02)
Set the motor full load according to the motor nameplate.
- (04) PM motor pole number (22-03).
Set the number of motor poles according to the motor nameplate.
- (05) PM motor rated speed (22-04)
Set parameter 22-04 or 22-06, the inverter will automatically calculate the one or the other.
Set the motor rated speed in rpm according to the motor nameplate.
Note: Only set parameter 22-04 or 22-06, the inverter will automatically calculate the other one.
Formula: $n (22-04) = 120 * f (22-06) / P(22-03)$
- (06) PM motor maximum rotation speed (22-05)
Set the maximum motor rated speed in rpm according to the motor nameplate.
- (07) PM motor rated frequency (22-06)
Set the motor rated frequency according to the motor nameplate.

22-16	Offset angle of the magnetic pole and PG origin
Range	0~360 deg

22-17	PM motor tuning
Range	0: None 1: Magnetic pole alignment and loop adjustment 2: Magnetic pole alignment

22-18	Fault history of PM motor tuning
Range	0: No error 1: Static magnetic alignment fault. 2: Without PG option card 3: Rotation pole alignment is forced to stop 4: Rotation pole alignment is time-out. 5: Loop adjustment is time out 6: Encoder error 7: Other error of motor tuning 8: Current abnormality occurs when aligning rotation magnetic pole 9: Current abnormality occurs while loop adjustment 10: Restart magnetic pole alignment and loop adjustment

(8) Offset angle of magnetic pole and PG origin (22-16)

Magnetic pole alignment offset value is stored in this parameter after tuning.

Note: Does not require adjustment.

(9) PM motor tuning (22-17)

WARNING!

Sudden start: The inverter and motor may start unexpectedly during Auto-Tuning, which could result in death or serious injury. Make sure the area surrounding of the motor and load are clear before proceeding with Auto-Tuning.

WARNING! Electric Shock Hazard

High voltage is supplied to the motor when performing an auto-tune, even when the motor is stopped, which could result in death or serious injury. Do not touch the motor when performing magnetic pole realignment until the auto-tuning procedure is completed.

WARNING! Holding Brake

Do not perform a magnetic pole realignment auto-tuning procedure when the motor is connected to a brake this may result in incorrect motor data calculation.

Disconnect the motor and the load and confirm that the motor can freely run.

1. Before selecting PM motor tuning, enter the motor data (22-00) - (22-06) according to the motor nameplate and the number of encoder pulses (20-27).

2.

- a) Use parameter 22-17 to select tuning mode.
- b) Next press the enter key to go to the PM motor tuning screen. The keypad will display the message of "IPrdy" (Ready to Tune).
- c) Press run to start the PM motor tuning. The keypad will display the "IPtun" message during auto-tune.
- d) If the motor is successfully tuned, the message of "IPEnd " will be displayed. If auto-tune is aborted with the stop key, the operator will display the message of " IPbrd "(PM motor tuning aborted).

Notes:

1. Perform a magnetic pole alignment auto-tune before adjusting the speed loop.
2. It is not required to perform a magnetic pole alignment auto-tune each time the inverter is powered up.
3. Parameter 22-18 shows the PM motor tuning fault history. If PM motor tuning has failed, the "IPErr" message is shown on the keypad (PM motor tuning failure) ; Refer to section 5 for the possible error causes and trouble shooting.
4. PM motor tuning fault history (22-18) only stores the result of the last auto-tune performed .If auto-tuning was successful or aborted no error will be displayed.

Information
provided by
EMAG
Tel: 01902 601403
www.emag-ltd.co.uk

4.5 Built-in PLC Function



The PLC ladder logic can be created and downloaded using the TECO drive link software.

4.5.1 Basic Command

				P			NO / NC
Inputs					I	i	I1~I8 / i1~i8
Outputs	Q	Q	Q	Q	Q	q	Q1~Q2 / q1~q2
Auxiliary command	M	M	M	M	M	m	M1~MF / m1~mF
Special registers							V1~V7
Counter function	C				C	c	C1~C8 / c1~c8
Timer function	T				T	t	T1~T8 / t1~t8
Analog comparison function	G				G	g	G1~G8 / g1~g8
Operation control function	F				F	f	F1~F8 / f1~f8
summation and subtraction function	AS						AS1~4
Multiplication and division function	MD						MD1~4

Description of registers

V1: Set frequency	Range: 0.1~1200.0Hz
V2: Operation frequency	Range: 0.1~1200.0Hz
V3: AI1 input value	Range: 0~1000
V4: AI2 input value	Range: 0~1000
V5: Keypad input value	Range: 0~1000
V6: Operation current	Range: 0.1~999.9A
V7: Torque value	Range: 0.1~200.0%

Command	Upper Differential	Lower Differential	Other command symbol
Differential command	D	d	
SET command			
RESET command			
P command			P

Open circuit	“ ”	
Short circuit	“_”	

Connection symbol	Definition
—	Connect components on the left and right side
⊥	Connects components on the left , right and top side
⊕	Connects components on the left , right , top and bottom side
⊔	Connects components on the left , right and bottom side

4.5.2 Basic Command Function

© D (d) command function

Example 1: I1-D —[Q1

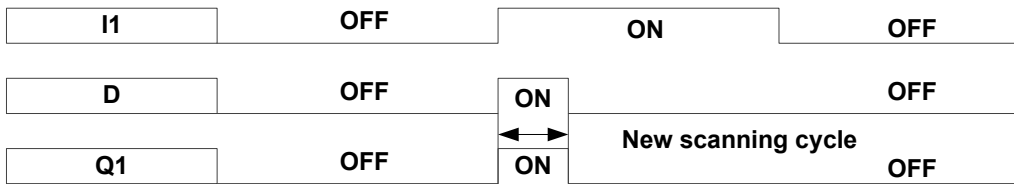

Example 2: i1-d —[Q1

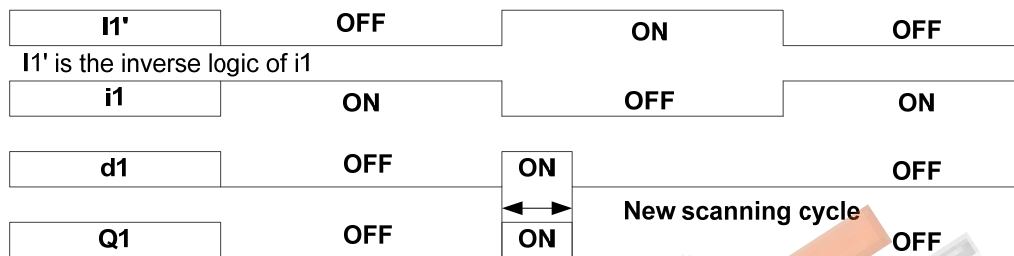

© NORMAL(-[) output

I1—[Q1



© SET (^) output

I1—^ Q1



© RESET (v) output

I1—v Q1

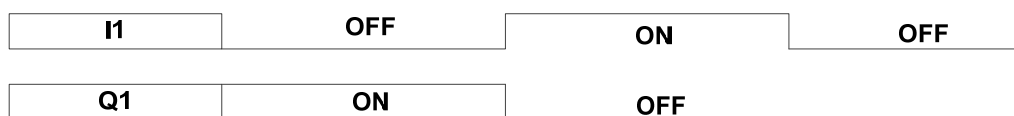

© P output

i1—PQ1

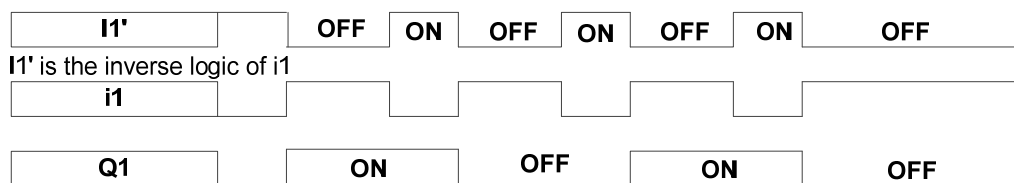

4.5.3 Application Functions

1: Counter Function

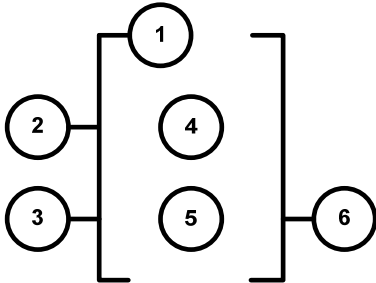

Symbol	Description
①	Counter mode (1 ~ 4)
②	UP/Down counting modes can be set by (I1 ~ f8).
	OFF: Count up (0, 1, 2, 3...)
	ON: Count down (...3,2,1,0)
③	Use (I1~f8) to reset counting value
	ON: Internal count value is reset and counter output ⑥ is OFF
	OFF: Internal counter value retained
④	Internal counter value
⑤	Counter compare value (AS1~AS4,MD1~MD4,T1~T8,C1~C8,V1~V7,constant)
⑥	Counter output (C1 to C8, there are a total of 8 counters)

Counter modes:

Mode 1: Counter value is locked to the set value. The value will not be retained when the power is cut off.

Mode 2: Counter value is not locked. The value will not be retained when the power is cut off.

Mode 3: Counter value is locked. The value will be retained when the power is cut off.

Mode 4: Counter value is not locked. The value will be retained when the power is cut off.

Counter mode 1

Example:

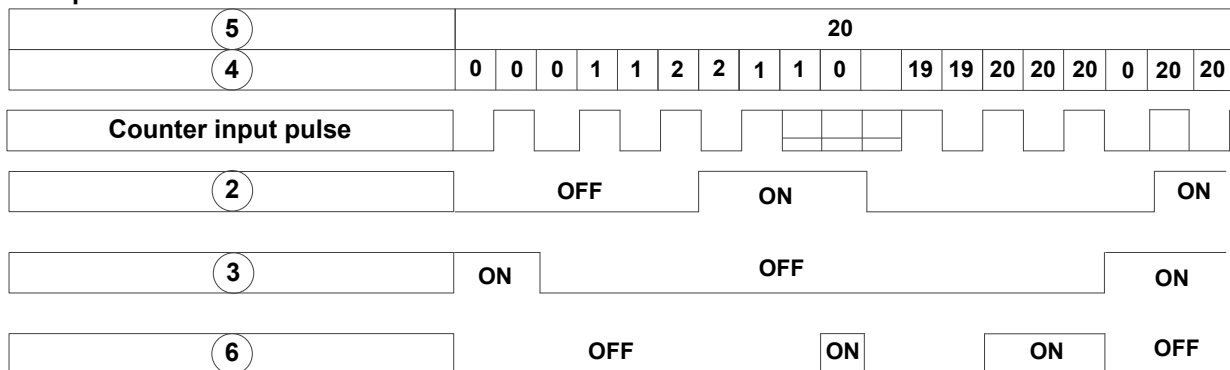

Input from ladder program

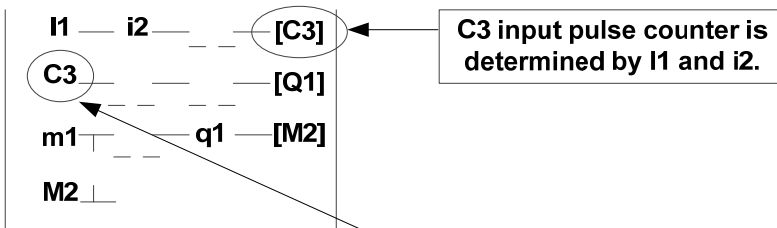

Input from the function program

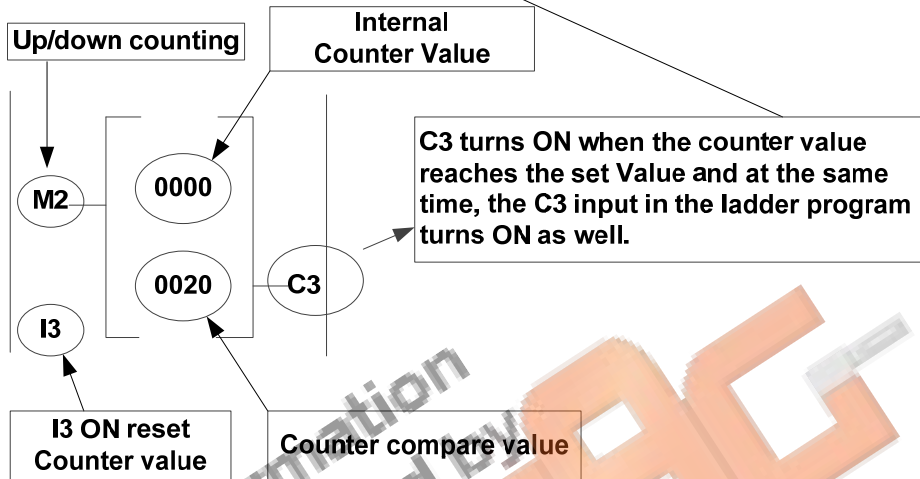

Counter mode 2

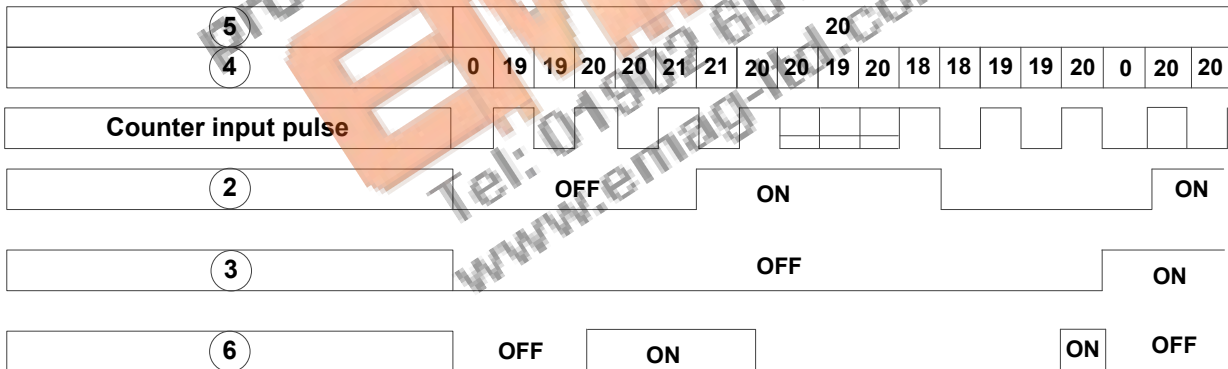

Note: In this mode the internal counter may increase past the counter compare value, unlike mode 1 where the internal counter value is limited to the counter compare value.

(1) Counter mode 3 is similar to the counter mode 1, with the exception that the counter value is saved when the drive is powered down and reloaded at power up.

(2) Counter mode 4 is similar to the counter mode 2, with the exception that the counter value is saved when the drive is powered down and reloaded at power up.

5		20													
4	Mode 1 & 2	1	1	2	2						0	1	1	2	2
4	Mode 3 & 4	1	1	2	2	3					3	4	4	5	5

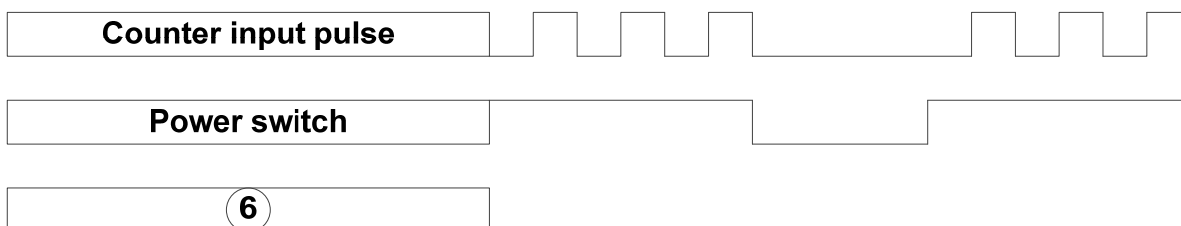

Information
provided by **EMAG**
Tel: 01902 601403
www.emag-ltd.co.uk

2: Timer Function

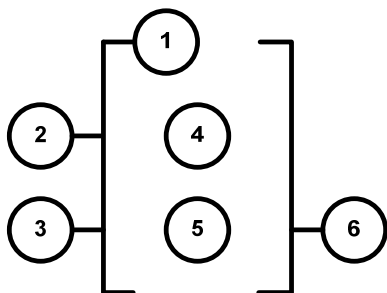

Symbol	Description
①	Timer mode (1-7)
②	Timing unit: 1:0.0~999.9 second
	2:0~9999 second
	3:0~9999 minute
③	Use (I1~f8) to reset timing value
	ON: Internal timing value is reset and timer output ⑥ is OFF OFF: Internal timer stays running
④	Internal timer value
⑤	Timer set value (AS1~AS4,MD1~MD4,T1~T8,C1~C8,V1~V7,constant)
⑥	Timer output (T1 to T8, there are a total of 8 timers)

Timer mode description:

(1) Timer mode 1 (ON-delay Timer mode 1)

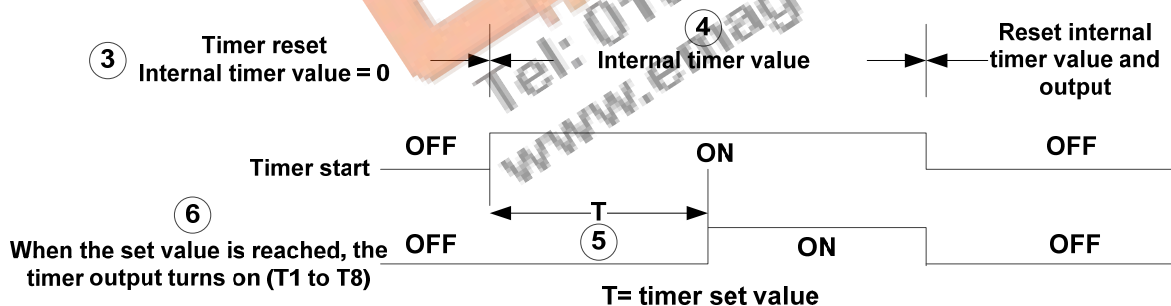

Example:

Input from the Ladder Program

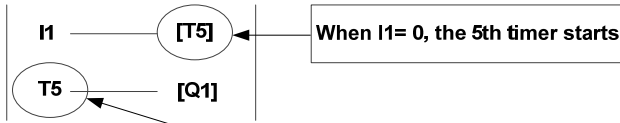

Input under function Program Mode

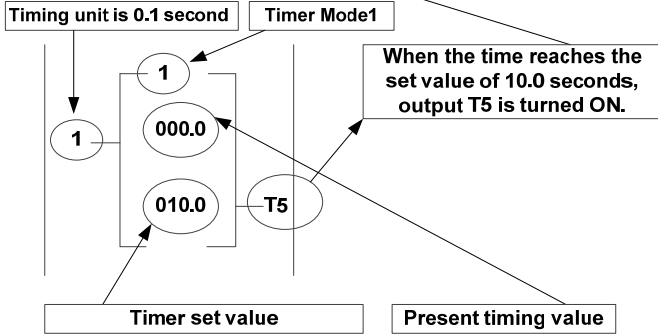

(2) Timer mode 2 (ON-delay Timer mode 2)

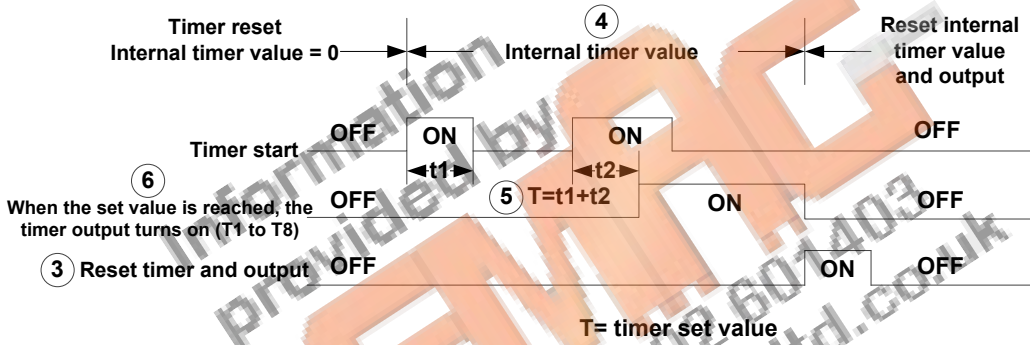

(3) Timer mode 3 (OFF-delay Timer mode 1)

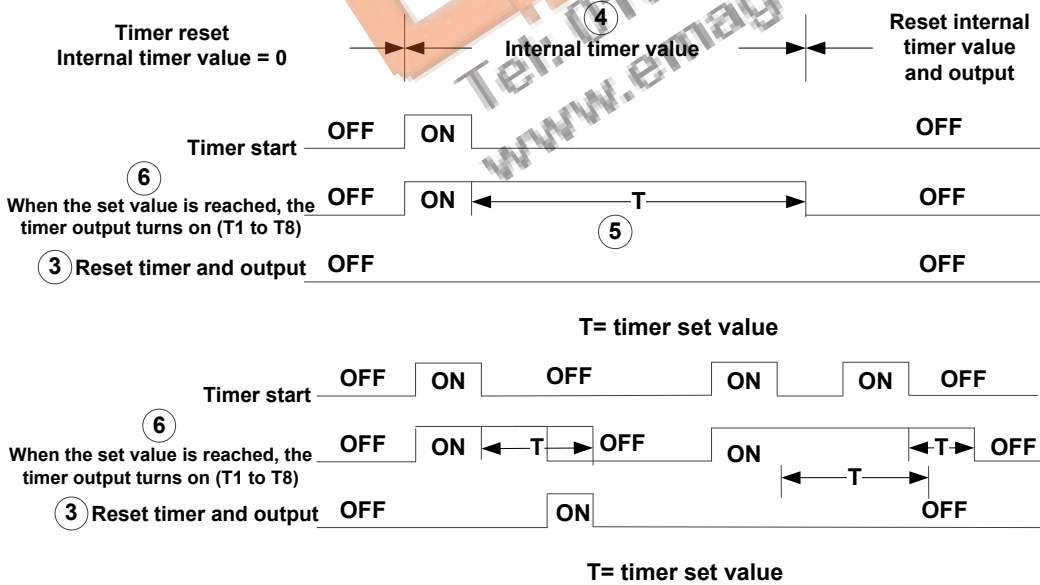

(4) Timer mode 4 (OFF-delay Timer mode 2)

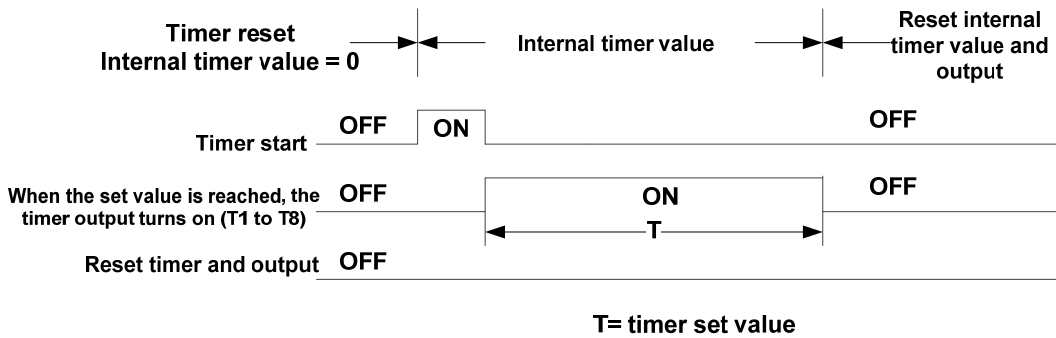

(5) Timer mode 5 (FLASH Timer mode 1)

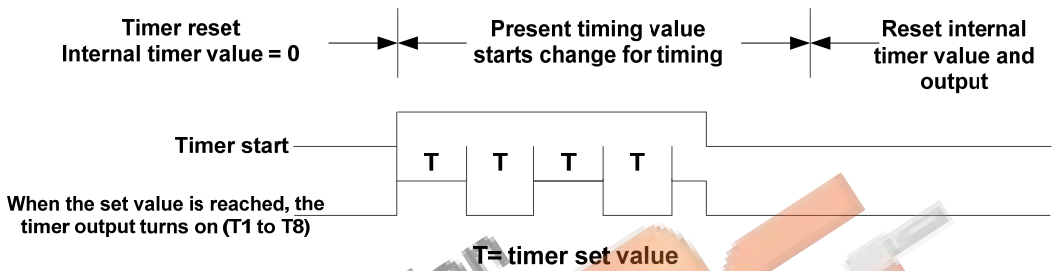

(6) Timer mode 6 (FLASH Timer mode 2)

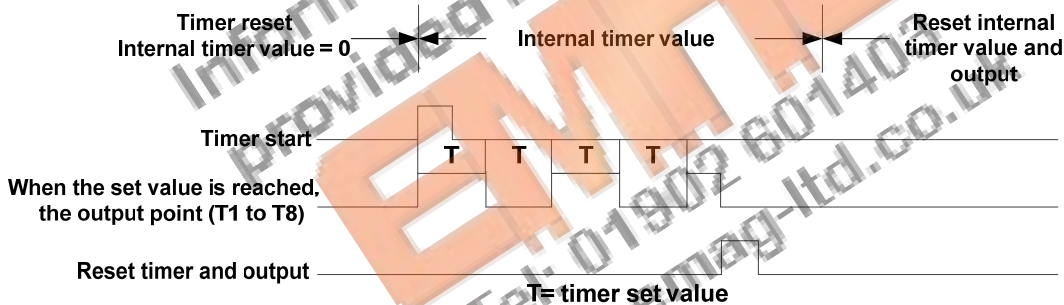

(7) Timer mode 7 (FLASH Timer mode 3)

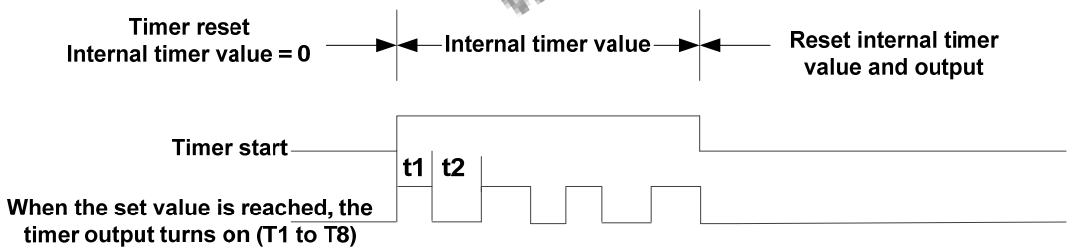

3: Analog comparator function

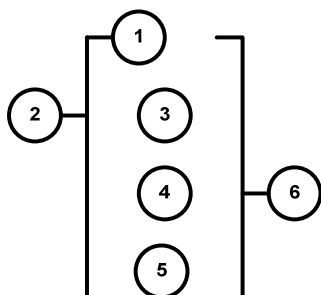

Symbol	Description
①	Analog comparator mode (1~3)
②	Input comparison value selection (AS1~AS4,MD1~MD4,T1~T8,C1~C8,V1~V7)
③	Current analog input value
④	Set the reference comparison value (Upper limit) (AS1~AS4,MD1~MD4,T1~T8,C1~C8,V1~V7, constant)
⑤	Set the reference comparison value (lower limit) (AS1~AS4,MD1~MD4,T1~T8,C1~C8,V1~V7, constant)
⑥	Comparator output (G1 to G8, there are a total of 8 comparators)

The description of analog comparison mode:

- (1) Analog comparison mode 1 ($③ \leq ⑤$, ⑥ ON)
- (2) Analog comparison mode 2 ($③ \geq ④$, ⑥ ON)
- (3) Analog comparison mode 3 ($⑤ \leq ③ \leq ④$, ⑥ ON)

Input comparison value selection (V1~V7)

- (1) Input comparison value selection = V1: Set frequency
- (2) Input comparison value selection = V2: Operation frequency
- (3) Input comparison value selection = V3: AI1 input value
- (4) Input comparison value selection = V4: AI2 input value
- (5) Input comparison value selection = V5: Keypad input value
- (6) Input comparison value selection = V6: Operation current
- (7) Input comparison value selection = V7: Torque value

4: Operation control function

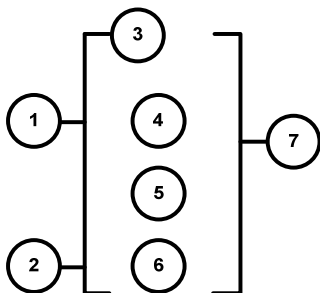

Symbol	Description
①	Forward /Reversal control can be set by (I1~f8) OFF: Forward(FWD) ON: Reversal(REV)
②	Speed terminal control can be set by (I1~f8) OFF: Operation based on ③ set frequency ON: Operation based on frequency of speed ④
③	Set frequency (can be constant or V3、 V4、 V5)
④	Speed frequency (can be constant or V3、 V4、 V5)
⑤	Acceleration time (ACC Time)
⑥	Deceleration time (DEC Time)
⑦	Operation command output (F1 to F8, there are a total of 8 operation control functions)

Example:

Input from the Ladder Program



Input from Function Program

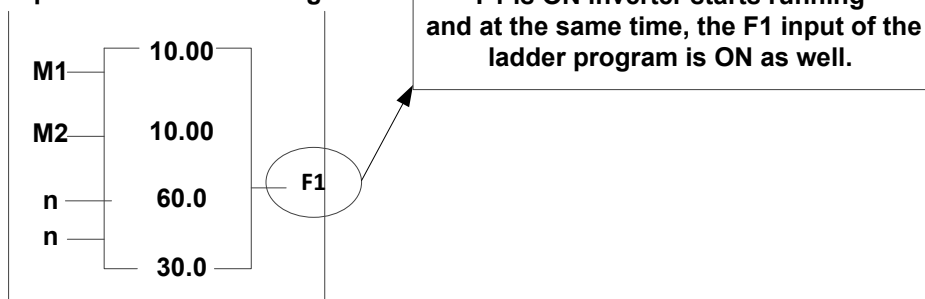

5: Summation and subtraction functions

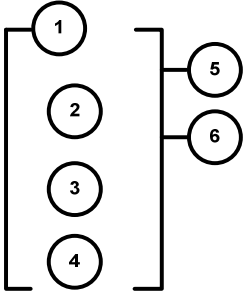

RESULT (calculation result) = V1+ V2- V3

Symbol	Description
①	Calculation result : RESULT
②	Addend V1(AS1~AS4,MD1~MD4,T1~T8,C1~C8,V1~V7, constant)
③	Addend V2(AS1~AS4,MD1~MD4,T1~T8,C1~C8,V1~V7, constant)
④	Subtrahend V3(AS1~AS4,MD1~MD4,T1~T8,C1~C8,V1~V7, constant)
⑤	Coil output of error signal (M1~MF)
⑥	Addition and subtraction modes number (AS1~AS4)

6: Multiplication and division modes

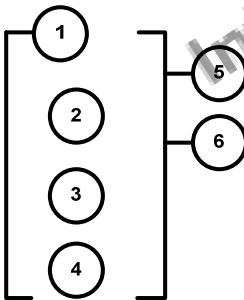

RESULT (calculation result) =V1*V2/V3

Symbol	Description
①	Calculation result : RESULT
②	Multiplier V1(AS1~AS4,MD1~MD4,T1~T8,C1~C8,V1~V7, constant)
③	Multiplier V2(AS1~AS4,MD1~MD4,T1~T8,C1~C8,V1~V7, constant)
④	Divisor V3(AS1~AS4,MD1~MD4,T1~T8,C1~C8,V1~V7, constant)
⑤	Coil output of error signal (M1~MF)
⑥	Multiplication and division modes number (MD1~ MD4)

4.6 Modbus Protocol Descriptions

4.6.1 Communication Connection and Data Frame

The inverter can communicate with a PC or PLC via RS485 or RS232 using the Modbus RTU or Modbus ACSII protocol. The maximum frame length is 80 bytes.

Network Connection

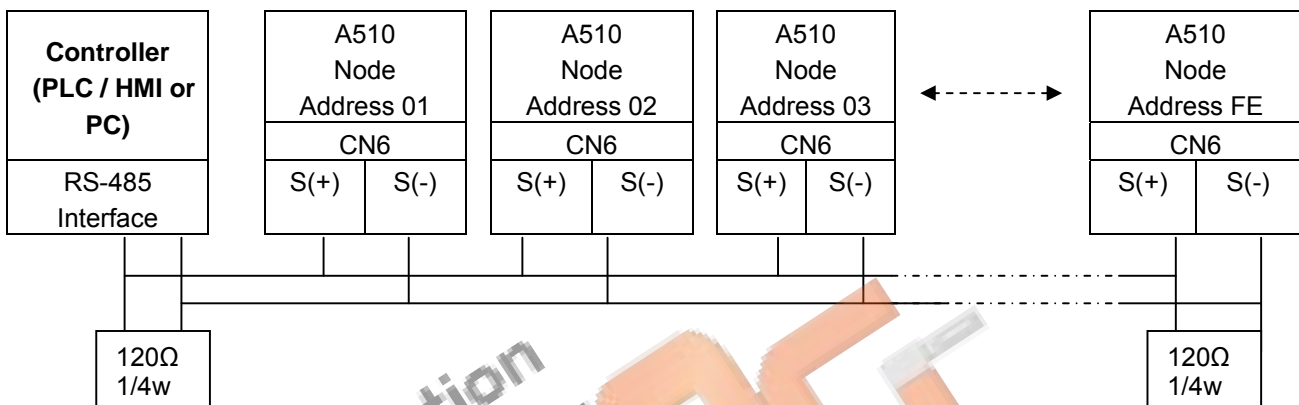

**** Terminate the communications line with a (120 ohm, 1/4 watt) resistor at both ends.**

CN6 Pin out

PIN	Signal	PIN	Signal
1	RS-485 S+ signal	5	Tx signal
2	RS-485 S- signal	6	RS-485 S- signal
3	RS-485 S+ signal	7	VCC of isolated 5V power supply
4	Rx signal	8	GND of isolated 5V power supply

The diagram shows a D-sub connector with pins numbered 1 through 8 from right to left. The pinout table provides the signal assignments for each pin.

For RS-485 communication use pin 1 or pin 3 for S (+) and pin 2 or pin 6 for S (-)

Data Format Frame

Data Frame for ASCII Mode

STX(3AH)	Start Bit = 3AH
Node Address Hi	Communication Address(Station):
Node Address Lo	
Function Hi	Function Code (command):
Function Lo	
Command Start Address	Command Start byte:
Command Start Address	
Command Start Address	
Command Start Address	
Data length	The length of the command:
Data length	
Data length	
Data length	
LRC Check Hi	LRC Check Code:
LRC Check Lo	
END Hi	End Byte:
END Lo	

Data Frame for RTU Mode

Master (PLC etc.) sends request to follower (inverter), and the follower sends a response to the master (PC, PLC). The data received is illustrated here.

The data length varies depending on the command (Function).

Node Address
Function Code
DATA
CRC CHECK
Signal Interval

** The inverter response time is 10ms.

Node Address

00H: Broadcast to all the drivers

01H: to the No. 01 inverter

0FH: to the No.15 inverter

10H: to the No.16 inverter and so on....., max to No. 254 (FEH)

Function Code

03H: Read the register contents

- 06H: Write a WORD to register
- 08H: Loop test
- 10H: Write several data to register (complex number register write)

Checksum Calculation

LRC

ex.	NODE ADDRESS	01H	
	FUNCTION	03H	
	COMMAND	01H	
		00H	
+	DATA LENGTH	0AH	
		0FH	----- 2's complement
	Checksum	F1H	
	CS (H)	46H	(ASCII)
	CS (L) =	31H	(ASCII)

CRC

CRC Check: CRC code covers the content from node address to DATA. Please calculate it according to the following methods.

- (1) Load a 16-bit register with FFFF hex (all 1's). Call this CRC register.
- (2) Exclusive OR the first 8-bit byte of the message, the low-order byte of the 16-bit CRC register, putting the result in the CRC register.
- (3) Shift the CRC register one bit to the right (toward the LSB), Zero-filling the MSB, Extract and examines the LSB.
- (4) (If the LSB was 0): Repeat Steps (3) (another shift)
 (If the LSB was 1): Exclusive OR the CRC register with the polynomial value A001 hex (1010 0000 0000 0001), putting the result in CRC register.
- (5) Repeat Steps (3) and (4) until 8 shifts been performed. When this is done, a complete 8-bit byte will be processed.
- (6) Repeat Steps (2) through (5) for next 8-bit byte of the message, Continue doing this until all bytes have been processed. The final content in the CRC register is the CRC value. When sending the CRC value, the Low-order byte should be sent firstly, then the High-order byte. For example, CRC value: 1241 Hex, the high-order byte should be set to 41hex and low-order byte 12hex.

CRC calculate program (C language):

```

UWORD ch_sum (UBYTE long, UBYTE *rxdbuf )
{
    BYTE i = 0;
    UWORD wkg = 0xFFFF;
    while ( long-- ) {
        wkg ^= rxdbuf++;
        for ( i = 0 ; i < 8; i++ ) {
            if ( wkg & 0x0001 ) {
                wkg = ( wkg >> 1 ) ^ 0xa001;
            }
            else {
                wkg = wkg >> 1;
            }
        }
    }
    return( wkg );
}

```

ASCII Mode	
STX	‘:’
Address	‘0’ ‘1’
Function	‘8’ ‘6’
Exception code	‘5’ ‘1’
LRC Check	‘2’ ‘8’
END	‘CR’ ‘LF’

RTU Mode		
Node Address		02H
Function		83H
Exception code		52H
CRC-16	High	C0H
	Low	CDH

During a communication error the drive will response with an Exception Code and send a message back to the main system consisting of a Function Code that is “ANDED (and 80h)” with 80 Hex.

Exception code	Content
01	Function code error
02	Register number error
03	Number error
04	DATA setting error

4.6.2 Register and Data Format

Command Data (Read / Write)

Register No.	Bit	Content
2500H	Reserved	
2501H	0	Operation Command 1 : Run 0 : Stop
	1	Reverse Command 1 : Reverse 0 : Forward
	2	External Fault 1 : Fault
	3	Fault Reset 1 : Reset
	4	Reserved
	5	Reserved
	6	Multi-function Comm S1 1 : "ON"
	7	Multi-function Comm S2 1 : "ON"
	8	Multi-function Comm S3 1 : "ON"
	9	Multi-function Comm S4 1 : "ON"
	A	Multi-function Comm S5 1 : "ON"
	B	Multi-function Comm S6 1 : "ON"
	C	Multi-function Comm S7 1 : "ON"
	D	Multi-function Comm S8 1 : "ON"
E	Inverter mode 1 : "ON"	
F	Reserved	
2502H	Frequency Command	
2503H	Reserved	
2504H	Reserved	
2505H	AO1	
2506H	AO2	
2507H	DO	
2508H	Reserved	
2509H	Reserved	
250AH	Reserved	
250BH	Reserved	
250CH	Reserved	
250DH	Reserved	
250EH	Reserved	
250FH	Reserved	

Note: Write a zero into the register for not used bit; do not write data to a reserved register.

Monitor Data (Read-only)

Register No.	Bit	Content
2520H	0	Operation 1 : Run 0 : Stop
	1	Direction 1 : Reverse 0 : Forward
	2	Inverter ready 1 : ready 0 : unready
	3	Fault 1 : Abnormal
	4	Warning 1 : "ON"
	5	Zero Speed 1 : "ON"
	6	Is440V 1 : "ON"
	7	Frequency Agree 1 : "ON"
	8	Set Frequency Agree 1 : "ON"
	9	Frequency Detection 1 1 : "ON"
	A	Frequency Detection 2 1 : "ON"
	B	UnderVoltage 1 : "ON"
	C	Baseblock 1 : "ON"
	D	Freq Ref. not from Comm. 1 : "ON"
	E	Seq. not from Comm. 1 : "ON"
	F	OverTorque 1 : "ON"
2521H	0	31 Reserved
	1	UV 32 Under Torque
	2	OC 33 CF02
	3	OV 34 CF03
	4	OH1 35 CF04
	5	OL1 36 CF05
	6	OL2 37 CF06
	7	OH4 38 CF07
	8	OH5 39 CF08
	9	SC 40 CF09
	10	Ground OC 41 CF10
	11	Fuse broken 42 CF11
	12	Input Phase Loss 43 CF12
	13	Output Phase Loss 44 CF13
	14	PG Overspeed 45 CF14
	15	PG Open 46 CF15
	16	PG Speed Deviation 47 CF16
	17	External Fault 01 48 CF17
	18	External Fault 02 49 Feedback Fault Fault
	19	External Fault 03 50 Key Removed
	20	External Fault 04 51 OH
	21	External Fault 05 52 OH3
	22	External Fault 06 53 Modbus External Fault
	23	External Fault 07 54 Braking Transistor Fault
	24	External Fault 08 55 Braking Resistor Overheat
	25	External Fault 09 56 CE
	26	External Fault 10 57

		27	External Fault 11	58	
		28	External Fault 12	59	
		29	Overtorque	60	
		30	Reserved	61	
			Terminal S1		
		1	Terminal S2		
		2	Terminal S3		
		3	Terminal S4		
		4	Terminal S5		
		5	Terminal S6		
		6	Terminal S7		
		7	Terminal S8		
		8	Reserved		
		9	Reserved		
		A	Reserved		
		B	Reserved		
		C	Reserved		
		D	Reserved		
		E	Reserved		
		F	Reserved		
2522H	DI State				
2523H			Frequency command		
2524H			Output frequency		
2525H			Reserved		
2526H			DC voltage command		
2527H			Output current		
2528H			Warning		
2529H			Digital Output State		
252AH			Reserved		
252BH			Reserved		
252CH			Analog Input 1		
252DH			Analog Input 2		
252EH			Reserved		
252FH			A510/L510/E510 Check		

Note: Write a zero into the register for not used bit; do not write data to a reserved register.

Read Holding Register [03H]

Read consecutive holding registers. The address of the first holding register is specified in the protocol
 Example: Read frequency command from the inverter with node address 1.

ASCII Mode

Command Message

3AH	STX
30H	Node Address
31H	
30H	Function
33H	
30H	Starting Register
31H	
32H	
33H	
30H	Number of Registers
30H	
30H	
31H	
?	LRC CHECK
?	
0DH	END
0AH	

Response Message (Normal)

3AH	STX
30H	Node Address
31H	
30H	Function
33H	
30H	Data Length
32H	
31H	Data
37H	
37H	
30H	
?	LRC CHECK
?	
0DH	END
0AH	

Response Message (Error)

3AH	STX
30H	Node Address
32H	
38H	Function
33H	
35H	Exception code
32H	
?	LRC CHECK
?	
0DH	END
0AH	

RTU Mode

Command Message

Node Address	01 H	
Function	03H	
Starting Register	High	01H
	Low	23H
Number of Registers	High	00H
	Low	01H
CRC-16	High	74H
	Low	3CH

Response Message (Normal)

Node Address	01H	
Function	03H	
Data Length	02H	
Data	High	17H
	Low	70H
CRC-16	High	AFH
	Low	82H

Response Message (Error)

Node Address	02H	
Function	83H	
Exception code	52H	
CRC-16	High	C0H
	Low	CDH

Loop back test [08H]

Check the communication between the master and the follower (inverter). The data used can be arbitrary.

ASCII Mode

Command Message

3AH	STX
30H	Node Address
31H	
30H	Function
38H	
30H	Test Code
30H	
30H	
30H	
41H	DATA
35H	
33H	
37H	
?	LRC CHECK
?	
0DH	END
0AH	

Response Message (Normal)

3AH	STX
30H	Node Address
31H	
30H	Function
38H	
30H	Test Code
30H	
30H	
30H	
41H	DATA
35H	
33H	
37H	
?	LRC CHECK
?	
0DH	END
0AH	

Response Message (Error)

3AH	STX
30H	Node Address
31H	
38H	Function
38H	
32H	Exception code
30H	
?	LRC CHECK
?	
0DH	END
0AH	

RTU Mode

Command Message

Node Address	01 H	
Function	08H	
Test Code	High	00H
	Low	00H
DATA	High	A5H
	Low	37H
CRC-16	High	DAH
	Low	8DH

Response Message (Normal)

Node Address	01H	
Function	08H	
Test Code	High	00H
	Low	00H
DATA	High	A5H
	Low	37H
CRC-16	High	DAH
	Low	8DH

Response Message (Error)

Node Address	01H	
Function	88H	
Exception code	20H	
CRC-16	High	47H
	Low	D8H

Write Single Holding Register [06H]

Write single holding register. The register address of the holding register is specified in the message.

Example: Write a 60.00Hz frequency command to node address 1.

ASCII Mode

Command Message

3AH	STX
30H	Node Address
31H	
30H	Function
36H	
30H	Starting Register
31H	
30H	
32H	
31H	DATA
37H	
37H	
30H	
?	LRC CHECK
?	
0DH	END
0AH	

Response Message (Normal)

3AH	STX
30H	Node Address
31H	
30H	Function
36H	
30H	Starting Register
31H	
30H	
32H	
31H	DATA
37H	
37H	
30H	
?	LRC CHECK
?	
0DH	END
0AH	

Response Message (Error)

3AH	STX
30H	Node Address
31H	
38H	Function
36H	
35H	Exception code
32H	
?	LRC CHECK
?	
0DH	END
0AH	

RTU Mode

Command Message

Node Address	01 H	
Function	06H	
Start No	High	01H
	Low	02H
DATA	High	17H
	Low	70H
CRC-16	High	27H
	Low	E2H

Response Message (Normal)

Node Address	01H	
Function	06H	
Start No	High	01H
	Low	02H
DATA	High	17H
	Low	70H
CRC-16	High	27H
	Low	E2H

Response Message (Error)

Node Address	01H	
Function	86H	
Exception code	52H	
CRC-16	High	C3H
	Low	9DH

Write Multiple Holding Register [10H]

Write multiple holding registers. The address of the first holding register is specified in the message.

Example: Write a 60.00Hz frequency command to node address 1 and enable FWD run command.

ASCII Mode

Command Message

3AH	STX
30H	Node Address
31H	
31H	Function
30H	
30H	Starting Register
31H	
30H	
31H	
30H	Number of Registers
30H	
30H	
32H	
30H	Number of Bytes*
34H	
30H	DATA 1
30H	
30H	
31H	
31H	DATA 2
37H	
37H	
30H	
?	LRC CHECK
?	
0DH	END
0AH	

Response Message (Normal)

3AH	STX
30H	Node Address
31H	
31H	Function
30H	
30H	Starting Register
31H	
30H	
31H	
30H	Number of Registers
30H	
30H	
32H	
?	LRC CHECK
?	
0DH	END
0AH	

Response Message (Error)

3AH	STX
30H	Node Address
31H	
39H	Function
30H	
35H	Exception code
32H	
?	LRC CHECK
?	
0DH	END
0AH	

* Number of bytes is register amount x 2

RTU Mode

Command Message

Node Address		01H
Function		10H
Starting Register	High	01H
	Low	01H
Number of Registers	High	00H
	Low	02H
Number of Bytes*		04H
DATA 1	High	00H
	Low	01H
DATA 2	High	17H
	Low	70H
CRC-16	High	60H
	Low	27H

Response Message (Normal)

Node Address		01H
Function		10H
Starting Register	High	01H
	Low	01H
Number of Registers	High	00H
	Low	02H
CRC-16	High	11H
	Low	F4H

Response Message (Error)

Node Address		01H
Function		90H
Exception code		52H
CRC-16	High	CDH
	Low	FDH

* Data amount is register amount x 2

Information
provided by
EMAG
Tel: 01902 601403
www.emag-ltd.co.uk

4.6.3 Parameter Data

Function	Register No	Function	Register No	Function	Register No
Group 0		Group 1		Group 2	
0-00	0000H	1-00	0100H	2-00	0200H
0-01	0001H	1-01	0101H	2-01	0201H
0-02	0002H	1-02	0102H	2-02	0202H
0-03	0003H	1-03	0103H	2-03	0203H
0-04	0004H	1-04	0104H	2-04	0204H
0-05	0005H	1-05	0105H	2-05	0205H
0-06	0006H	1-06	0106H	2-06	0206H
0-07	0007H	1-07	0107H	2-07	0207H
0-08	0008H	1-08	0108H	2-08	0208H
0-09	0009H	1-09	0109H	2-09	0209H
0-10	000AH	1-10	010AH	2-10	020AH
0-11	000BH	1-11	010BH	2-11	020BH
0-12	000CH	1-12	010CH	2-12	020CH
0-13	000DH	1-13	010DH	2-13	020DH
0-14	000EH	1-14	010EH	2-14	020EH
0-15	000FH	1-15	010FH	2-15	020FH
0-16	0010H	1-16	0110H	2-16	0210H
0-17	0011H	1-17	0111H	2-17	0211H
0-18	0012H	1-18	0112H	2-18	0212H
0-19	0013H	1-19	0113H	2-19	0213H
0-20	0014H	1-20	0114H	2-20	0214H
0-21	0015H	1-21	0115H	2-21	0215H
0-22	0016H	1-22	0116H	2-22	0216H
0-23	0017H	1-23	0117H	2-23	0217H
0-24	0018H	1-24	0118H	2-24	0218H
0-25	0019H	1-25	0119H	2-25	0219H
0-26	001AH			2-26	021AH
0-27	001BH			2-27	021BH
0-28	001CH			2-28	021CH
0-29	001DH			2-29	021DH
0-30	001EH			2-30	021EH
0-31	001FH			2-31	021FH
0-32	0020H			2-32	0220H

Function	Register No	Function	Register No	Function	Register No
Group 3		Group 3		Group 4	
3-00	0300H	3-33	0321H	4-00	0400H
3-01	0301H	3-34	0322H	4-01	0401H
3-02	0302H	3-35	0323H	4-02	0402H
3-03	0303H	3-36	0324H	4-03	0403H
3-04	0304H	3-37	0325H	4-04	0404H
3-05	0305H	3-38	0326H	4-05	0405H
3-06	0306H			4-06	0406H
3-07	0307H			4-07	0407H
3-08	0308H			4-08	0408H
3-09	0309H			4-09	0409H
3-10	030AH			4-10	040AH
3-11	030BH			4-11	040BH
3-12	030CH			4-12	040CH
3-13	030DH			4-13	040DH
3-14	030EH			4-14	040EH
3-15	030FH			4-15	040FH
3-16	0310H			4-16	0410H
3-17	0311H			4-17	0411H
3-18	0312H			4-18	0400H
3-19	0313H				
3-20	0314H				
3-21	0315H				
3-22	0316H				
3-23	0317H				
3-24	0318H				
3-25	0319H				
3-26	031AH				
3-27	031BH				
3-28	031CH				
3-29	031DH				
3-30	031EH				
3-31	031FH				
3-32	0320H				

Function	Register No	Function	Register No	Function	Register No
Group 5		Group 5		Group 6	
5-00	0500H	5-33	0521H	6-00	0600H
5-01	0501H	5-34	0522H	6-01	0601H
5-02	0502H	5-35	0523H	6-02	0602H
5-03	0503H	5-36	0524H	6-03	0603H
5-04	0504H	5-37	0525H	6-04	0604H
5-05	0505H	5-38	0526H	6-05	0605H
5-06	0506H	5-39	0527H	6-06	0606H
5-07	0507H	5-40	0528H	6-07	0607H
5-08	0508H	5-41	0529H	6-08	0608H
5-09	0509H	5-42	052AH	6-09	0609H
5-10	050AH	5-43	052BH	6-10	060AH
5-11	050BH	5-44	052CH	6-11	060BH
5-12	050CH	5-45	052DH	6-12	060CH
5-13	050DH	5-46	052EH	6-13	060DH
5-14	050EH	5-47	052FH	6-14	060EH
5-15	050FH	5-48	0530H	6-15	060FH
5-16	0510H			6-16	0610H
5-17	0511H			6-17	0611H
5-18	0512H			6-18	0612H
5-19	0513H			6-19	0613H
5-20	0514H			6-20	0614H
5-21	0515H			6-21	0615H
5-22	0516H			6-22	0616H
5-23	0517H			6-23	0617H
5-24	0518H			6-24	0618H
5-25	0519H			6-25	0619H
5-26	051AH			6-26	061AH
5-27	051BH			6-27	061BH
5-28	051CH			6-28	061CH
5-29	051DH			6-29	061DH
5-30	051EH			6-30	061EH
5-31	051FH			6-31	061FH
5-32	0520H			6-32	0620H

Function	Register No	Function	Register No	Function	Register No
Group 6		Group 7		Group 8	
6-33	0621H	7-00	0700H	8-00	0800H
6-34	0622H	7-01	0701H	8-01	0801H
6-35	0623H	7-02	0702H	8-02	0802H
6-36	0624H	7-03	0703H	8-03	0803H
6-37	0625H	7-04	0704H	8-04	0804H
6-38	0626H	7-05	0705H	8-05	0805H
6-39	0627H	7-06	0706H	8-06	0806H
6-40	0628H	7-07	0707H	8-07	0807H
6-41	0629H	7-08	0708H	8-08	0808H
6-42	062AH	7-09	0709H	8-09	0809H
6-43	062BH	7-10	070AH	8-10	080AH
6-44	062CH	7-11	070BH	8-11	080BH
6-45	062DH	7-12	070CH	8-12	080CH
6-46	062EH	7-13	070DH	8-13	080DH
6-47	062FH	7-14	070EH	8-14	080EH
		7-15	070FH	8-15	080FH
		7-16	0710H	8-16	0810H
		7-17	0711H	8-17	0811H
		7-18	0712H	8-18	0812H
		7-19	0713H	8-19	0813H
		7-20	0714H	8-20	0814H
		7-21	0715H	8-21	0815H
		7-22	0716H	8-22	0816H
		7-23	0717H	8-23	0817H
		7-24	0718H	8-24	0818H
		7-25	0719H	8-25	0819H
		7-26	071AH		
		7-27	071BH		
		7-28	071CH		

Function	Register No	Function	Register No	Function	Register No
Group 9		Group 10		Group 11	
9-00	0900H	10-00	0A00H	11-00	0B00H
9-01	0901H	10-01	0A01H	11-01	0B01H
9-02	0902H	10-02	0A02H	11-02	0B02H
9-03	0903H	10-03	0A03H	11-03	0B03H
9-04	0904H	10-04	0A04H	11-04	0B04H
9-05	0905H	10-05	0A05H	11-05	0B05H
9-06	0906H	10-06	0A06H	11-06	0B06H
9-07	0907H	10-07	0A07H	11-07	0B07H
9-08	0908H	10-08	0A08H	11-08	0B08H
9-09	0909H	10-09	0A09H	11-09	0B09H
		10-10	0A0AH	11-10	0B0AH
		10-11	0A0BH	11-11	0B0BH
		10-12	0A0CH	11-12	0B0CH
		10-13	0A0DH	11-13	0B0DH
		10-14	0A0EH	11-14	0B0EH
		10-15	0A0FH	11-15	0B0FH
		10-16	0A10H	11-16	0B10H
		10-17	0A11H	11-17	0B11H
		10-18	0A12H	11-18	0B12H
		10-19	0A13H	11-19	0B13H
		10-20	0A14H	11-20	0B14H
		10-21	0A15H	11-21	0B15H
		10-22	0A16H	11-22	0B16H
		10-23	0A17H	11-23	0B17H
		10-24	0A18H	11-24	0B18H
		10-25	0A19H	11-25	0B19H
		10-26	0A1AH	11-26	0B1AH
		10-27	0A1BH	11-27	0B1BH
		10-28	0A1CH	11-28	0B1CH
		10-29	0A1DH	11-29	0B1DH
				11-30	0B1EH
				11-31	0B1FH
				11-32	0B20H

Function	Register No	Function	Register No	Function	Register No
Group 11		Group 12		Group 12	
11-33	0B21H	12-00	0C00H	12-33	0C21H
11-34	0B22H	12-01	0C01H	12-34	0C22H
11-35	0B23H	12-02	0C02H	12-35	0C23H
11-36	0B24H	12-03	0C03H	12-36	0C24H
11-37	0B25H	12-04	0C04H	12-37	0C25H
11-38	0B26H	12-05	0C05H	12-38	0C26H
11-39	0B27H	12-06	0C06H	12-39	0C27H
11-40	0B28H	12-07	0C07H	12-40	0C28H
11-41	0B29H	12-08	0C08H	12-41	0C29H
11-42	0B2AH	12-09	0C09H	12-42	0C2AH
11-43	0B2BH	12-10	0C0AH	12-43	0C2BH
11-44	0B2CH	12-11	0C0BH	12-44	0C2CH
11-45	0B2DH	12-12	0C0CH	12-45	0C2DH
11-46	0B2EH	12-13	0C0DH	12-46	0C2EH
11-47	0B2FH	12-14	0C0EH	12-47	0C2FH
11-48	0B30H	12-15	0C0FH	12-48	0C30H
11-49	0B31H	12-16	0C10H	12-49	0C31H
11-50	0B32H	12-17	0C11H	12-50	0C32H
11-51	0B33H	12-18	0C12H	12-51	0C33H
11-52	0B34H	12-19	0C13H	12-52	0C34H
11-53	0B35H	12-20	0C14H	12-53	0C35H
11-54	0B36H	12-21	0C15H	12-54	0C36H
11-55	0B37H	12-22	0C16H	12-55	0C37H
11-56	0B38H	12-23	0C17H	12-56	0C38H
11-58	0B3AH	12-24	0C18H	12-57	0C39H
		12-25	0C19H	12-58	0C3AH
		12-26	0C1AH	12-59	0C3BH
		12-27	0C1BH	12-60	0C3CH
		12-28	0C1CH	12-61	0C3DH
		12-29	0C1DH	12-62	0C3EH
		12-30	0C1EH	12-63	0C3FH
		12-31	0C1FH	12-64	0C40H
		12-32	0C20H	12-65	0C41H

Function	Register No	Function	Register No	Function	Register No
Group 13		Group 14		Group 14	
13-00	0D00H	14-00	0E00H	14-34	0E22H
13-01	0D01H	14-01	0E01H	14-35	0E23H
13-02	0D02H	14-02	0E02H	14-36	0E24H
13-03	0D03H	14-03	0E03H	14-37	0E25H
13-04	0D04H	14-04	0E04H	14-38	0E26H
13-05	0D05H	14-05	0E05H	14-39	0E27H
13-06	0D06H	14-06	0E06H	14-40	0E28H
13-07	0D07H	14-07	0E07H	14-41	0E29H
13-08	0D08H	14-08	0E08H	14-42	0E2AH
13-09	0D09H	14-09	0E09H	14-43	0E2BH
		14-10	0E0AH	14-44	0E2CH
		14-11	0E0BH	14-45	0E2DH
		14-12	0E0CH	14-46	0E2EH
		14-13	0E0DH	14-47	0E2FH
		14-14	0E0EH		
		14-15	0E0FH		
		14-16	0E10H		
		14-17	0E11H		
		14-18	0E12H		
		14-19	0E13H		
		14-20	0E14H		
		14-21	0E15H		
		14-22	0E16H		
		14-23	0E17H		
		14-24	0E18H		
		14-25	0E19H		
		14-26	0E1AH		
		14-27	0E1BH		
		14-28	0E1CH		
		14-29	0E1DH		
		14-30	0E1EH		
		14-31	0E1FH		
		14-32	0E20H		
		14-33	0E21H		

Function	Register No	Function	Register No	Function	Register No
Group 15		Group 16		Group 17	
15-00	0F00H	16-00	1000H	17-00	1100H
15-01	0F01H	16-01	1001H	17-01	1101H
15-02	0F02H	16-02	1002H	17-02	1102H
15-03	0F03H	16-03	1003H	17-03	1103H
15-04	0F04H	16-04	1004H	17-04	1104H
15-05	0F05H	16-05	1005H	17-05	1105H
15-06	0F06H	16-06	1006H	17-06	1106H
15-07	0F07H	16-07	1007H	17-07	1107H
15-08	0F08H	16-08	1008H	17-08	1108H
15-09	0F09H	16-09	1009H	17-09	1109H
15-10	0F0AH			17-10	110AH
15-11	0F0BH			17-11	110BH
15-12	0F0CH				
15-13	0F0DH				
15-14	0F0EH				
15-15	0F0FH				
15-16	0F10H				
15-17	0F11H				
15-18	0F12H				
15-19	0F13H				
15-20	0F14H				
15-21	0F15H				
15-22	0F16H				
15-23	0F17H				
15-24	0F18H				
15-25	0F19H				
15-26	0F1AH				
15-27	0F1BH				
15-28	0F1CH				
15-29	0F1DH				
15-30	0F1EH				
15-31	0F1FH				
15-32	0F20H				

Function	Register No	Function	Register No	Function	Register No
Group 18		Group 19		Group 20	
18-00	1200H	19-00	1300H	20-00	1400H
18-01	1201H	19-01	1301H	20-01	1401H
18-02	1202H	19-02	1302H	20-02	1402H
18-03	1203H	19-03	1303H	20-03	1403H
18-04	1204H	19-04	1304H	20-04	1404H
18-05	1205H	19-05	1305H	20-05	1405H
18-06	1206H	19-06	1306H	20-06	1406H
		19-07	1307H	20-07	1407H
				20-08	1408H
				20-09	1409H
				20-10	140AH
				20-11	140BH
				20-12	140CH
				20-13	140DH
				20-14	140EH
				20-15	140FH
				20-16	1410H
				20-17	1411H
				20-18	1412H
				20-19	1413H
				20-20	1414H
				20-21	1415H
				20-22	1416H
				20-23	1417H
				20-24	1418H
				20-25	1419H
				20-26	141AH
				20-27	141BH
				20-28	141CH
				20-29	141DH
				20-30	141EH
				20-31	141FH
				20-32	1420H

Function	Register No	Function	Register No	Function	Register No
Group 21		Group 21		Group 22	
21-00	1500H	21-33	1521H	22-00	1600H
21-01	1501H	21-34	1522H	22-01	1601H
21-02	1502H	21-35	1523H	22-02	1602H
21-03	1503H	21-36	1524H	22-03	1603H
21-04	1504H	21-37	1525H	22-04	1604H
21-05	1505H	21-38	1526H	22-05	1605H
21-06	1506H	21-39	1527H	22-06	1606H
21-07	1507H	21-40	1528H	22-07	1607H
21-08	1508H	21-41	1529H	22-08	1608H
21-09	1509H	21-42	152AH	22-09	1609H
21-10	150AH	21-43	152BH	22-10	160AH
21-11	150BH			22-11	160BH
21-12	150CH			22-12	160CH
21-13	150DH			22-13	160DH
21-14	150EH			22-14	160EH
21-15	150FH			22-15	160FH
21-16	1510H			22-16	1610H
21-17	1511H			22-17	1611H
21-18	1512H			22-18	1612H
21-19	1513H				
21-20	1514H				
21-21	1515H				
21-22	1516H				
21-23	1517H				
21-24	1518H				
21-25	1519H				
21-26	151AH				
21-27	151BH				
21-28	151CH				
21-29	151DH				
21-30	151EH				
21-31	151FH				
21-32	1520H				

Chapter 5 Check Motor Rotation and Direction

This test is to be performed solely from the inverter keypad. Apply power to the inverter after all the electrical connections have been made and protective covers have been re-attached.

Important: Motor rotation and direction only applies to standard AC motors with a base frequency of 60Hz. For 50Hz or other frequency AC motors please set the max frequency and base frequency in group 01 accordingly before running the motors.

◆ LED Keypad Display

At this point, **DO NOT RUN THE MOTOR**, the LED keypad should display as shown below in Fig. 5.1 and all LEDs are flashing. Next press the **RUN** key, all LEDs light on. See Fig 5.2. The motor should now be operating at low speed running in forward (clockwise) direction. The value shown in the screen will change from 000.00Hz to 005.00Hz. Next press **STOP** key to stop the motor.



Fig 5.1: LED Keypad (Stopped)



Fig 5.2: LED Keypad (Running)

◆ LCD Keypad Display

At this point, **DO NOT RUN THE MOTOR**, the LCD keypad should display as shown below in Fig. 5.3 and the speed reference 12-16=005.00Hz should be blinking at the parameter code "12-16". Next press the **RUN** key, see Fig 5.4. The motor should now be operating at low speed running in forward (clockwise) direction. The parameter code 12-17 shown at the bottom left corner of the screen will change from 12-17=000.00Hz to 12-17=005.00Hz. Next press **STOP** key to stop the motor.



Fig 5.3: LCD Keypad (Stopped)



Fig 5.4: LCD Keypad (Running)

Notes:

- If the motor rotation is incorrect, power down the inverter.
- After the power has been turned OFF, wait at least ten minutes until the charge indicator extinguishes completely before touching any wiring, circuit boards or components.
- Using Safety precaution, and referring to section 3.8 exchange any two of the three output leads to the motor (U/T1, V/T2 and W/T3). After the wiring change, repeat this step and recheck motor direction.

Chapter 6 Speed Reference Command Configuration

The inverter offers users several choices to set the speed reference source. The most commonly used methods are described in the next sections.

Frequency reference command is selected with parameter 00-05.

00-05: Main Frequency Command (Frequency Source)

This function sets the frequency command source.

Setting Range: 0 to 5

To set parameter 00-05:

- After power-up press the **DSP/FUN** key
- Set Group **00** (Basic Fun), and select parameter -05 with the **UP/DOWN ▲** and **▼** keys and press the **READ/ ENTER** key.

00-05	Main Frequency Command Source Selection
Range	0: Keypad 1: External control (analog) 2: Terminal UP / DOWN 3: Communication control 4: Pulse input 5: PID

6.1 Reference from Keypad

◆ LED Keypad:

Use the **</RESET**, **▲** and **▼** keys to change the speed reference and then press the **READ/ ENTER** key. Refer to section 4.1.5 for more details.

◆ LCD Keypad:

Press the **READ/ ENTER** key first and use the **</RESET**, **▲** and **▼** keys to change the speed reference.

6.2 Reference from External Analog Signal (0-10V / 4-20mA)

Analog Reference: 0 – 10 V (Setting 00-05 = 1)

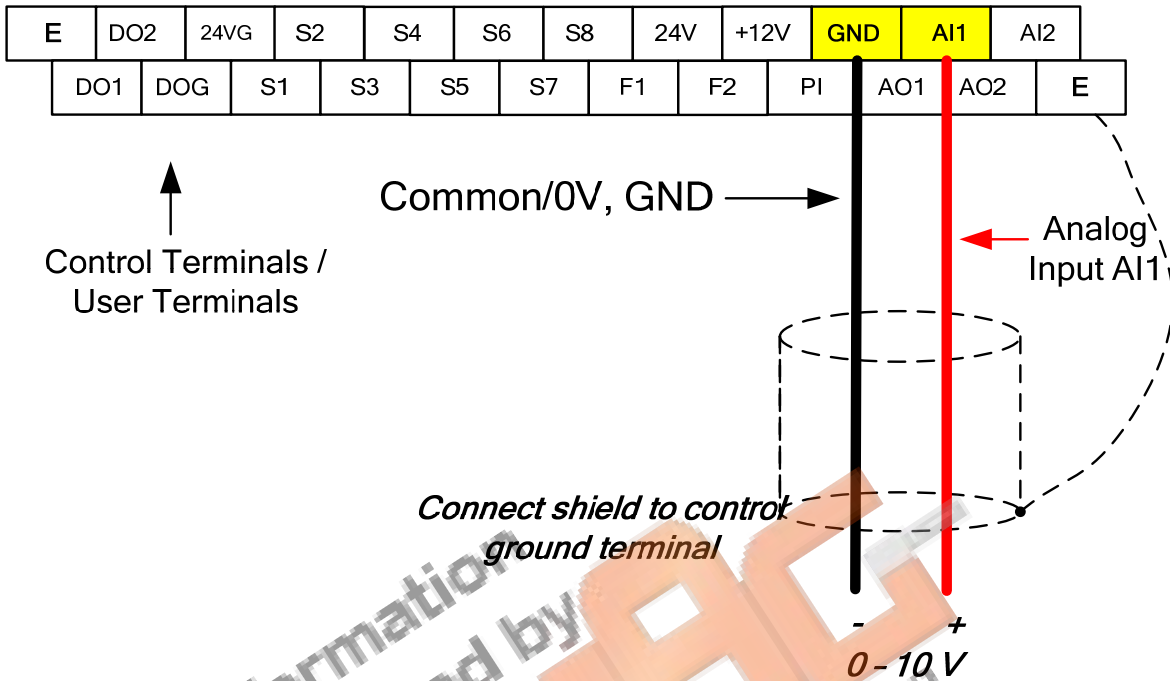

Analog Reference: Potentiometer / Speed Pot (Setting 00-05 = 1)

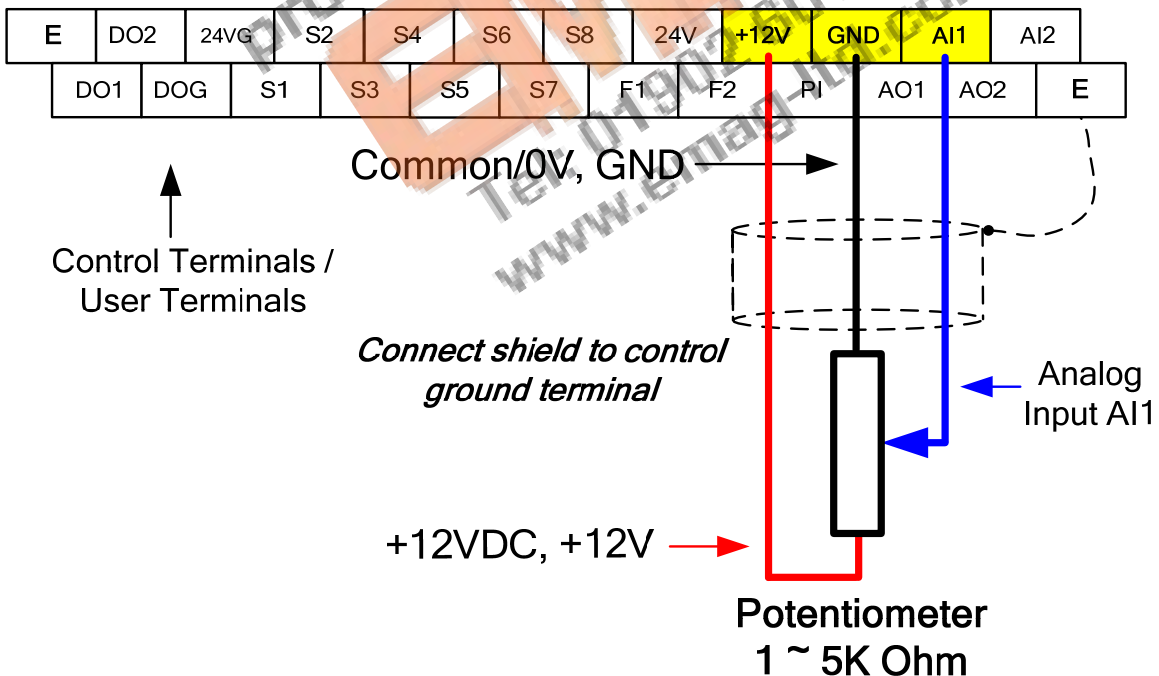

Analog Reference: 4 – 20mA (Setting 00-05 = 1)

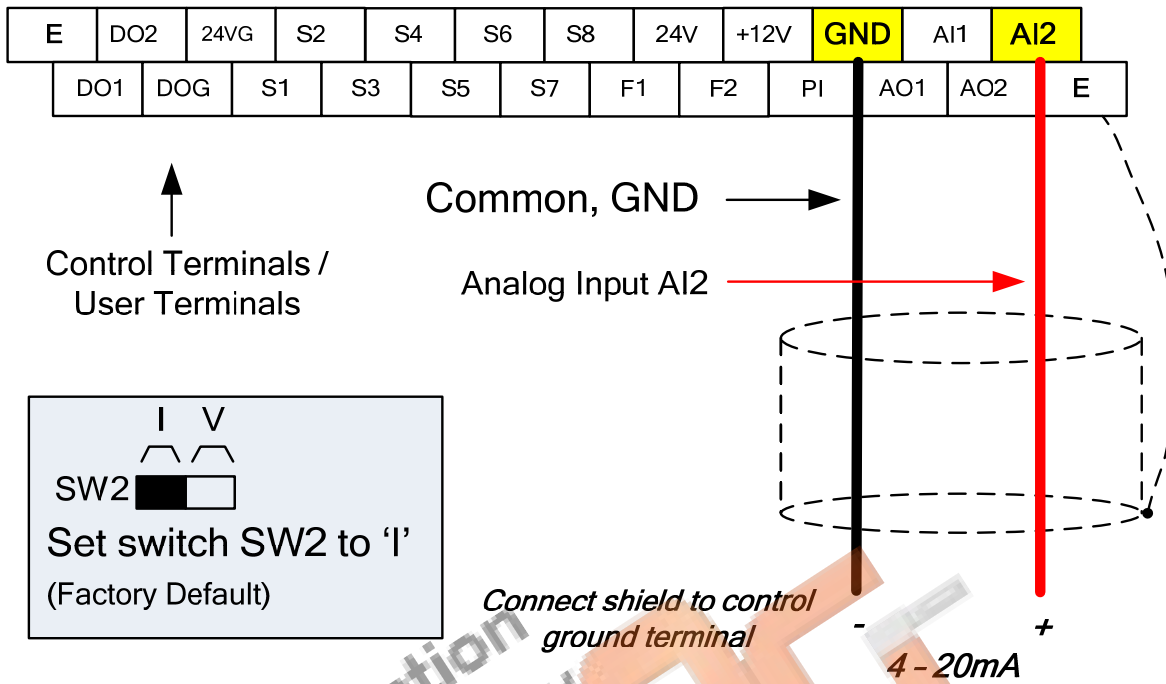

Information provided by **EMAG**
Tel: 01902 601403
www.emag-ltd.co.uk

6.3 Reference from Serial Communication RS485 (00-05=3)

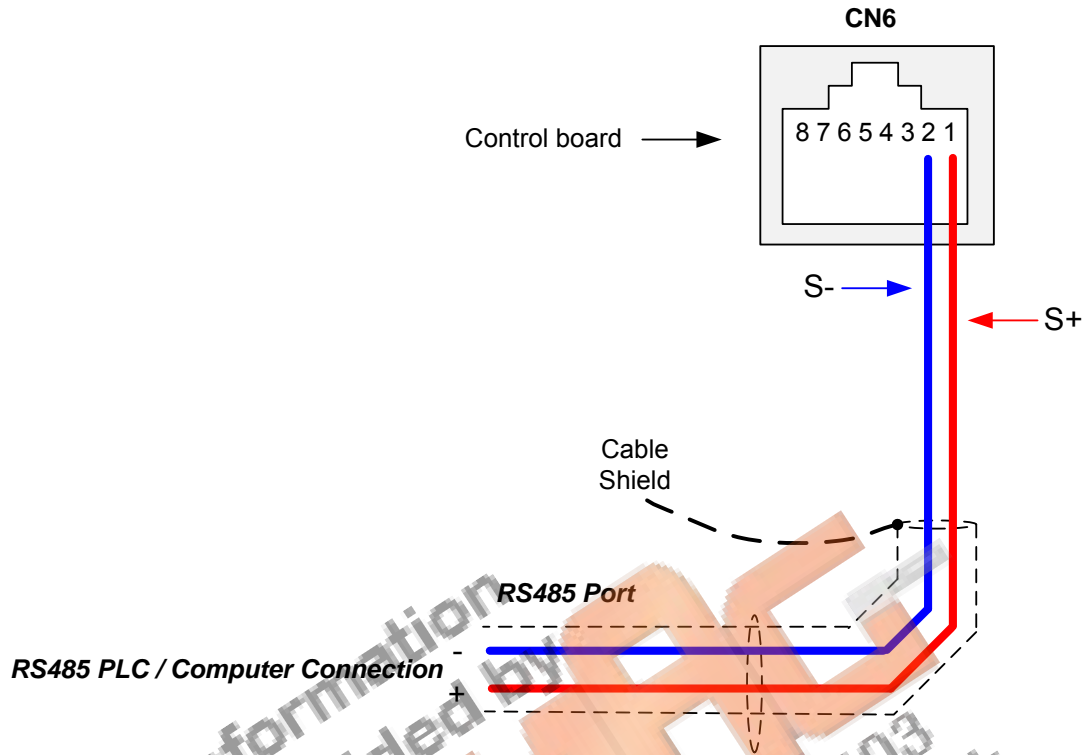

To set the speed reference for the inverter via serial communication parameter 00-05 has be set to “3” for frequency command via serial communication.

Default Communication Setting is: Address “1”, 9600 Bits/sec, 1 Start Bit, 1 Stop Bit, and No Parity

The serial communication link function uses RS485 Modbus RTU protocol and allows for:

- 1) Monitoring (data monitoring, function data check).
- 2) Frequency setting.
- 3) Operation command (FWD, REV, and other commands for digital input).
- 4) Write function data.

Frequency Reference Command Register

Inverter Frequency Reference Register: 2502 (Hexadecimal) - Bit 0 – Bit 15: 0.00 ~ 400.00 Hz

Examples:

Frequency Reference Command: 10.00 Hz (Inverter Node Address: 01)

Command String (hexadecimal): 01 06 25 02 03 E8 23 B8

To set the frequency reference to 10.00, a value of '1000' (03E8h) has to be send to the inverter.

Frequency Reference Command: 30.00 Hz (Inverter Node Address: 01)

Command String (hexadecimal): 01 06 25 02 0B B8 24 44

To set the frequency reference to 30.00, a value of '3000' (0BB8h) has to be send to the inverter.

Frequency Reference Command: 60.00 Hz (Inverter Node Address: 01)

Command String (hexadecimal): 01 06 25 02 17 70 2D 12

To set the frequency reference to 60.00, a value of '6000' (1770h) has to be send to the inverter

Note: The last 2 bytes of the command strings consist of a CRC16 checksum, please refer to section 4.5 of the instruction manual for additional information.

Information
provided by
EMAG
Tel: 01902 601403
www.emag-ltd.co.uk

6.4 Reference from Pulse Input (00-05=4)

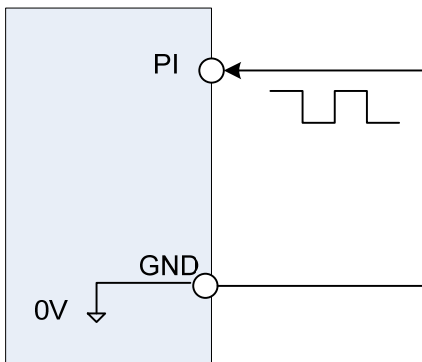

Serial pulse input
(Internal resistance : 3.89 K)

Specification

Low Input Level: 0.0 to 0.5 V
High Input Level: 4.0 to 13.5 V
Duty cycle: (ON / OFF) 30 % to 70%
Pulse Input frequency range: 50 to 32 KHz

Set Pulse Input Setup as Frequency Reference

Set parameter 00-05 to 4 and 03-30 to 0 to use the pulse input terminal PI as the frequency reference source. Next set the pulse input scaling (03-31), enter the pulse input frequency to match the maximum output frequency. Adjust the pulse input filter time in case interference or noise is encountered.

Example: Pulse train input maximum 10 kHz, set parameter 03-31 to 10000 when maximum frequency is set to 60.0Hz.

03- 30	Function setting of pulse input
Range	0: Frequency command 1: PID feedback 2: PID target value 3: Reserved

Function selects source for the pulse input.

03-31	Scale of pulse input
Range	50 ~ 32000 Hz

Pulse input scaling, 100% = Maximum pulse frequency.

03- 32	Pulse input gain
Range	0.0~1000.0 %

Target value (03-03) in % = Pulse input frequency scaled to 100% based on maximum pulse frequency (03-31) times the gain (03-32) + bias (03-33).

03-33	Pulse input bias
Range	-100.0~100.0 %

Target value (03-03) in % = Pulse input frequency scaled to 100% based on maximum pulse frequency (03-31) times the gain (03-32) + bias (03-33).

03-34	Pulse input filter time
Range	0.00~2.00 Sec

6.5 Reference from two Analog Inputs

Analog input AI1 is used as master frequency reference and analog input AI2 is used as auxiliary frequency reference.

Analog Reference AI1: 0 – 10 V (Setting 00-05 = 1)

Analog Reference AI2: 0 – 10 V (Setting 00-06 = 1, 04-05 = 1)

AI1 – Analog Input 1	AI2 – Analog Input 2	04-00 Setting (Default = 1)	Dipswitch SW2 (Default 'V')
0 ~ 10V	0 ~ 10V	0	Set to 'V'
0 ~ 10V	4 ~ 20mA	1	Set to 'I'

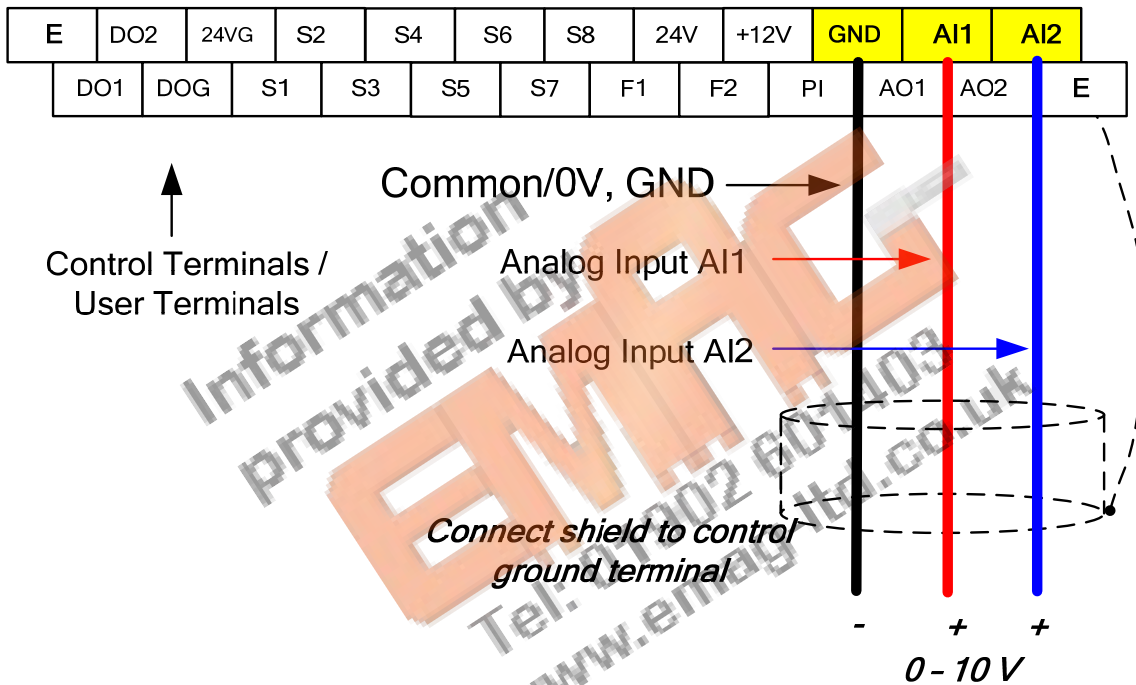

6.6 Change Frequency Unit from Hz to rpm

Enter the number of motor poles in 16-03 to change the display units from Hz to rpm.

16-03	Display unit
Range	0: Display unit is Hz (Resolution is 0.01Hz)
	1: Display unit is % (Resolution is 0.01%)
	2~39: Display unit rpm, (uses number of motor poles to calculate)
	40~9999: 100% is XXXX with no decimals (integer only)
	10001~19999: 100% is XXX.X with 1 decimal
	20001~29999: 100% is XX.XX with 2 decimals
30001~39999: 100% is X.XXX with 3 decimals	

Example: Motor poles 4, 16-03 = 4.

Chapter 7 Operation Method Configuration (Run / Stop)

The inverter offers users several choices to run and stop from different sources. The most commonly used methods are described in the next sections.

Operation command is selected with parameter 00-02.

00-02: Run Command Selection

This function sets the frequency command source.

Setting Range: 0 to 3

To set parameter 00-02:

- After power-up press the **DSP/FUN** key
- Set Group **00** (Basic Fun), and select parameter -02 with the **UP/DOWN ▲** and **▼** keys and press the **READ/ ENTER** key.

00-02	Run Command Selection
Range	0: Keypad control 1: External terminal control 2: Communication control 3: PLC

7.1 Run/Stop from the LED/LCD Keypad (00-02=0)

Use the **RUN** key to run the drive in forward direction and the **FWD/REV** key to change the motor direction. (Note: to disable reverse direction set parameter 11-01 to 1)

Press **STOP** key to stop the inverter. (Note: Stop method can be set with parameter 07-09, default is **deceleration to stop**).



7.2 Run/Stop from External Switch / Contact or Pushbutton (00-02=1)

Use an external contact or switch to Run and Stop the inverter.

Example: NPN wiring

◆ Permanent Switch / Contact

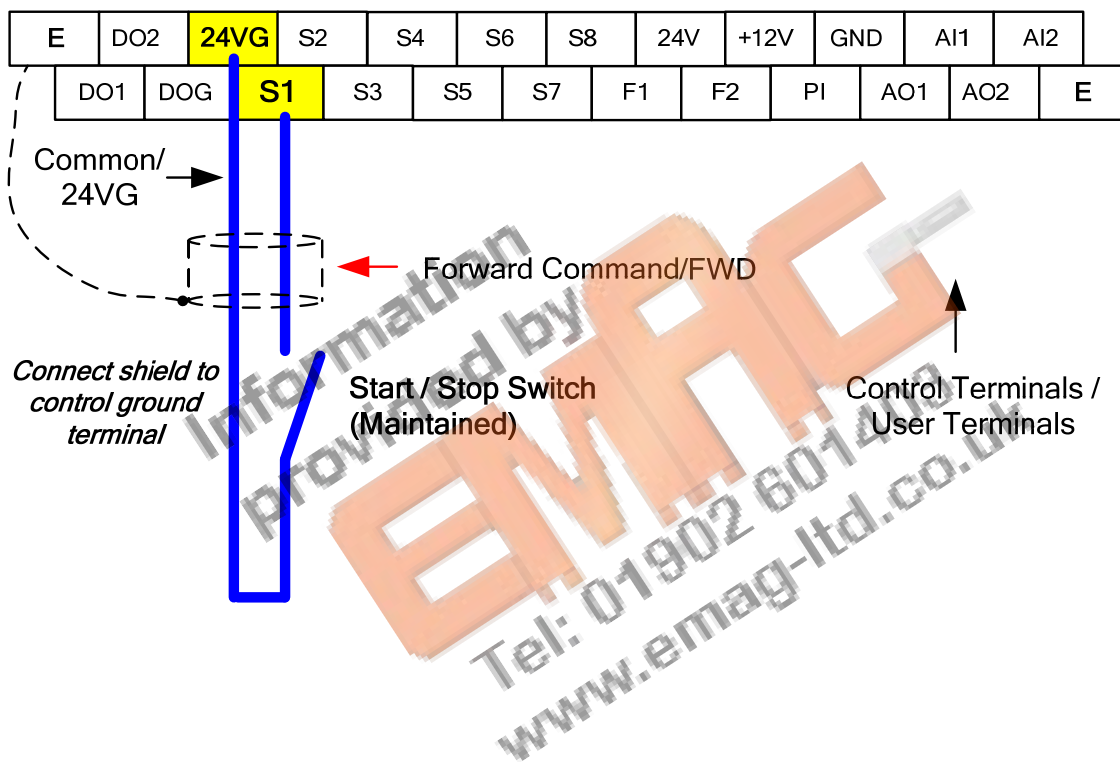

◆ **Momentary Contacts (Push Buttons)**

Use push button / momentary switch to Run and Stop the inverter.

Set parameter 13-08 to 3, 5 or 7 for 3-wire program initialization, multi-function input terminal S1 is set to run operation, S2 for stop operation and S7 for forward/reverse command.

00-01 Operation Method = 1

03-07 Terminal S7 Function = 26

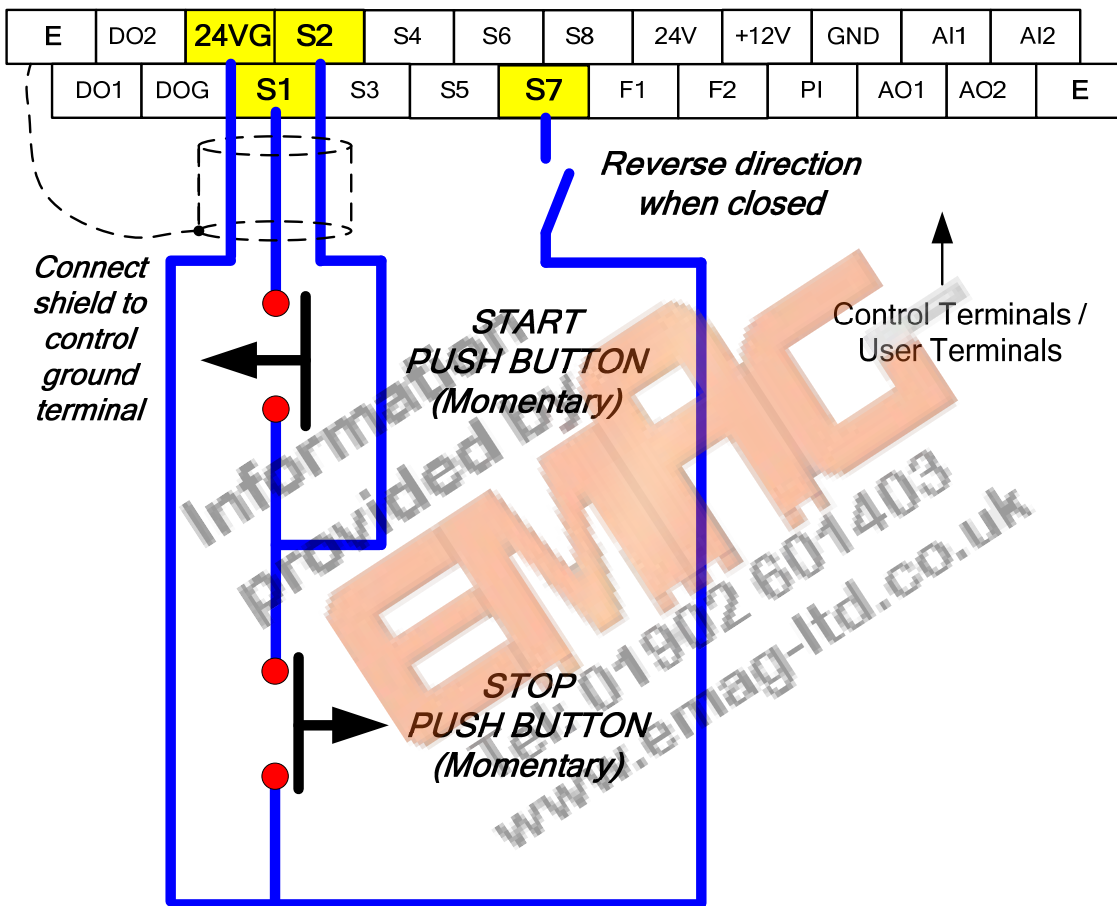

Note: Stop mode selection can be set with parameter 07-09, default is **deceleration to stop**.

7.3 Run/Stop from Serial Communication RS485 (00-02=3)

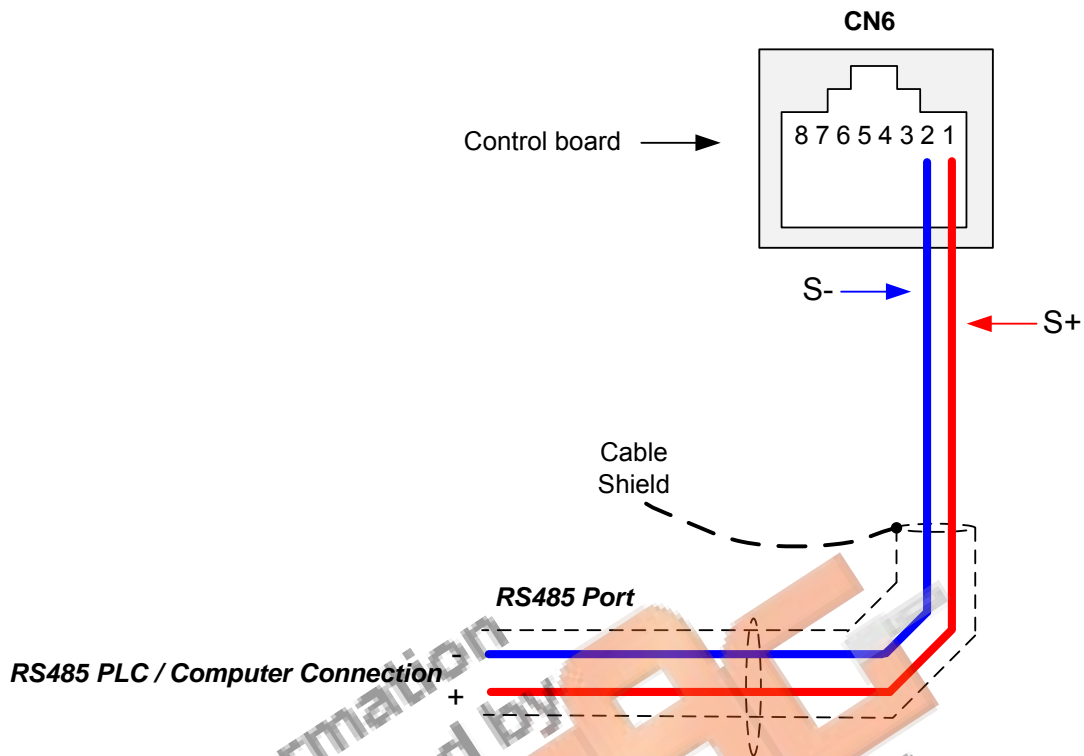

To control (Run/Stop) the inverter via serial communication parameter 00-02 has be set to either a “3” for communication control.

Default Communication Setting is: Address “1”, 9600 Bits/sec, 1 Start Bit, 1 Stop Bit, and No Parity

The serial communication link function uses RS485 Modbus RTU protocol and allows for:

- 1) Monitoring (data monitoring, function data check).
- 2) Frequency setting.
- 3) Operation command (FWD, REV, and other commands for digital input).
- 4) Write function data.

Command Register

Inverter Command Register: 2501 (Hexadecimal)

Bit 0: Run Forward

Bit 1: Run Reverse

Bit 2 ~ Bit 15: Refer to the chapter XX of this manual

Examples:

Run Forward Command (Inverter Node Address: 01)

Command String (hexadecimal): 01 06 25 01 00 01 12 C6

Run Reverse Command (Inverter Node Address: 01)

Command String (hexadecimal): 01 06 25 01 00 03 93 07

Stop Command (Inverter Node Address: 01)

Command String (hexadecimal): 01 06 25 01 00 00 D3 06

Note: The last 2 bytes of the command strings consist of a CRC16 checksum, please refer to section 4.5 of the instruction manual for additional information.

Information
provided by
EMAG
Tel: 01902 601403
www.emag-ltd.co.uk

Chapter 8 Motor and Application Specific Settings

It is essential that before running the motor, the motor nameplate data matches the motor data in the inverter.

8.1 Set Motor Nameplate Data (02-01, 02-05)

02-05 Rated power of motor 1

The nominal motor rated capacity is set at the factory. Please verify that the motor name plate data matches the motor rated capacity shown in parameter 02-05. The setting should only be changed when driving a motor with a different capacity.

Range: 0.00 to 600.00 kW (1HP = 0.746 kW)

To set parameter 02-05:

- After power-up press the **DSP/FUN** key
- Set Group **02** (Motor Parameter), and select parameter -05 with the **UP/DOWN ▲** and **▼** keys and press the **READ/ ENTER** key.

Default values vary based on the inverter model.

02-01 Rated current of motor 1

The motor rated current is set at the factory based on the inverter model. Enter the motor rated current from the motor nameplate if it does not match the value shown in parameter 02-01.

Setting range: 0.01 to 600.00A

To set parameter 02-01:

- After power-up press the **DSP/FUN** key
 - Set Group **02** (Motor Parameter), and select parameter -01 with the **UP/DOWN ▲** and **▼** keys and press the **READ/ ENTER** key.
-

8.2 Acceleration and Deceleration Time (00-14, 00-15)

Acceleration and Deceleration times directly control the system dynamic response. In general, the longer the acceleration and deceleration time, the slower the system response, and the shorter time, the faster the response. An excessive amount of time can result in sluggish system performance while too short of a time may result in system instability.

The default values suggested normally result in good system performance for the majority of general purpose applications. If the values need to be adjusted, caution should be exercised, and the changes should be in small increments to avoid system instability.

00-14 Acceleration time 1

00-15 Deceleration time 1

These parameters set the acceleration and deceleration times of the output frequency from 0 to maximum frequency and from maximum frequency to 0.

To set parameter 00-14 or 00-15:

- After power-up press the **DSP/FUN** key
- Set Group **00** (Basic Fun), and select parameter -14 or -15 with the **UP/DOWN ▲** and **▼** keys and press the **READ/ ENTER** key.

Acceleration and deceleration times are represented by the three most significant (high order) digits. Set acceleration and deceleration times with respect to maximum frequency. The relationship between the set frequency value and acceleration/deceleration times is as follows.

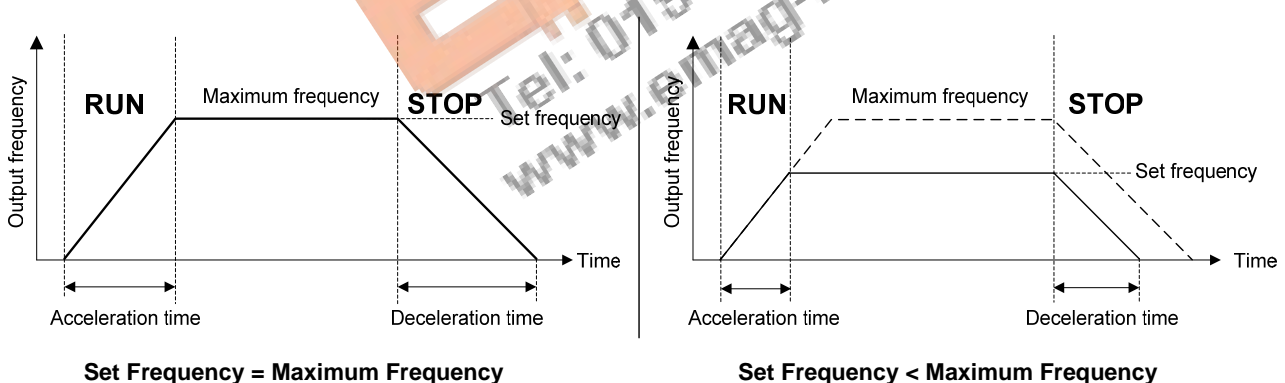

Note: If the set acceleration and deceleration times are set too low, the torque limiting function or stall prevention function can become activated if the load torque and or inertia are relatively high. This will prolong the acceleration and or deceleration times and not allow the set times to be followed. In this case the acceleration and or the deceleration times should be adjusted.

8.3 Torque Compensation Gain (01-10)

This parameter sets the relationship between output frequency and output voltage. Constant torque applications have the same torque requirements at low speed as well as at high speed.

Initial Setup

For Variable Torque / Normal Duty applications set parameter 01-10 to an initial value of 0.5.

For Constant Torque / Heavy Duty applications set parameter 01-10 to an initial value of 1.0.

01-10 Torque compensation gain

This parameter sets the torque boost for motor 1.

Setting range: 0.0 to 2.0

To set parameter 01-10:

- After power-up press the **DSP/FUN** key
- Set Group **01** (V/F Pattern), and select parameter -10 with the **UP/DOWN ▲** and **▼** keys and press the **READ/ ENTER** key.

Increase value when:

- The wiring between the inverter and the motor very too long
- The motor size is smaller than the inverter size

Note: Gradually increase the torque compensation value and make sure the output current does not exceed inverter rated current.

Reduce value when:

- Experiencing motor vibration
- Over Current Fault
- Overload Fault

Important: Confirm that the output current at low speed does not exceed the rated output current of the inverter.



Warning: A larger than required torque compensation gain value creates over-excitation at low speeds, continued operation may cause the motor to overheat. Check the characteristics of the motor for additional information.

8.4 Automatic Energy Saving Functions (11-19)

In the V/F control mode the automatic energy saving (AES) function automatically adjusts the output voltage and reduces the output current of the inverter to optimize energy savings based on the load.

The output power changes proportional to the motor load. Energy savings is minimal when the load exceeds 70% of the output power and savings become greater when the load decreases.

The parameter of automatic energy saving function has been set at the factory before shipment. In general, it is no need to adjust. If the motor characteristic has significant difference from TECO standard, please refer to the following commands for adjusting parameters:

Enable Automatic Energy Savings Function

To set parameters 11-19 to 11-24:

- After power-up press the **DSP/FUN** key
- Set Group **11** (Auxiliary Function Group), and select parameter -19 to -24 with the **UP/DOWN** ▲ and ▼ keys and press the **READ/ ENTER** key.

- (1) To enable automatic energy saving function set 11-19 to 1.
- (2) Filter time of automatic energy saving (11-20)
- (3) Commissioning parameter of energy saving (11-21 to 11-22)

In AES mode, the optimum voltage value is calculated based on the load power requirement but is also affected by motor temperature and motor characteristic.

In certain applications the optimum AES voltage needs to be adjusted in order to achieve optimum energy savings. Use the following AES parameters for manual adjustment:

11-21: Voltage limit value of AES commissioning operation

Sets the voltage upper limit during automatic energy saving. 100% corresponds to 220V or 440V depending on the inverter class used.

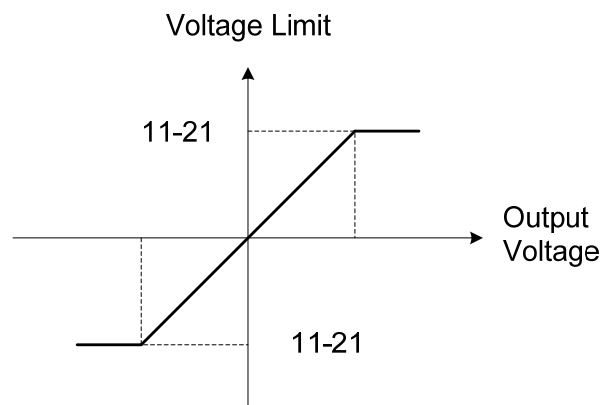

Voltage limit value of commissioning operation

11-22: Adjustment time of automatic energy saving

Set sample time constant for measuring output power.

Reduce the value of 11-22 to increase response when the load changes.

Note: If the value of 11-22 is too low and the load is reduced the motor may become unstable.

11-23: Detection level of automatic energy saving

Set the automatic energy saving output power detection level.

11-24: Coefficient of automatic energy saving

The coefficient is used to tune the automatic energy saving. Adjust the coefficient while running the inverter on light load while monitoring the output power. A lower setting means lower output voltage.

Notes:

- If the coefficient is set to low the motor may stall.
- Coefficient default value is based on the inverter rating. Set parameter 13-00. If the motor power does not match the inverter rating.

Information
provided by
EMAG
Tel: 01902 601403
www.emag-ltd.co.uk

8.5 Emergency Stop

The emergency stop time is used in combination with multi-function digital input function #14 (Emergency stop). When emergency stop input is activated the inverter will decelerate to a stop using the Emergency stop time (00-26) and display the [EM STOP] condition on the keypad.

Note: To cancel the emergency stop condition the run command has to be removed and emergency stop input deactivated.

Example: Emergency Stop Switch with NPN wiring set for input terminal S5 (03-04 = 14).

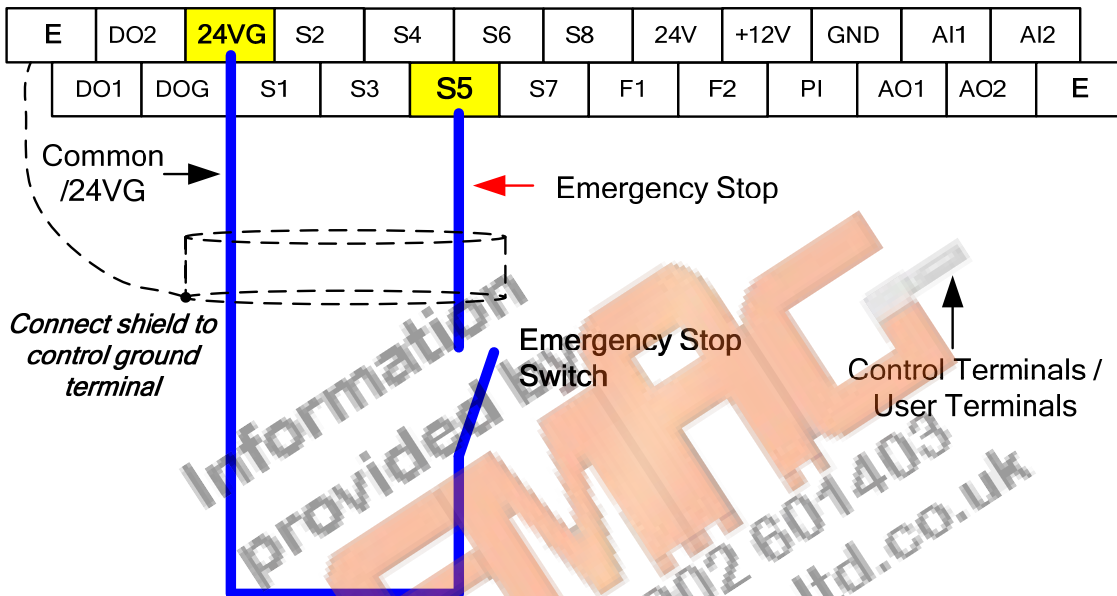

00-26	Emergency stop time
Range	0.0~6000.0 Sec

8.6 Forward and Reverse Jog

The jog forward command is used in combination with multi-function digital input function #6 (Jog Forward) and the jog reverse command is used in combination with multi-function digital input function #7 (Jog Reverse).

Example: Jog Forward input terminal S5 (03-04 = 06) and Jog Reverse input terminal S7 (03-06=7) with NPN wiring.

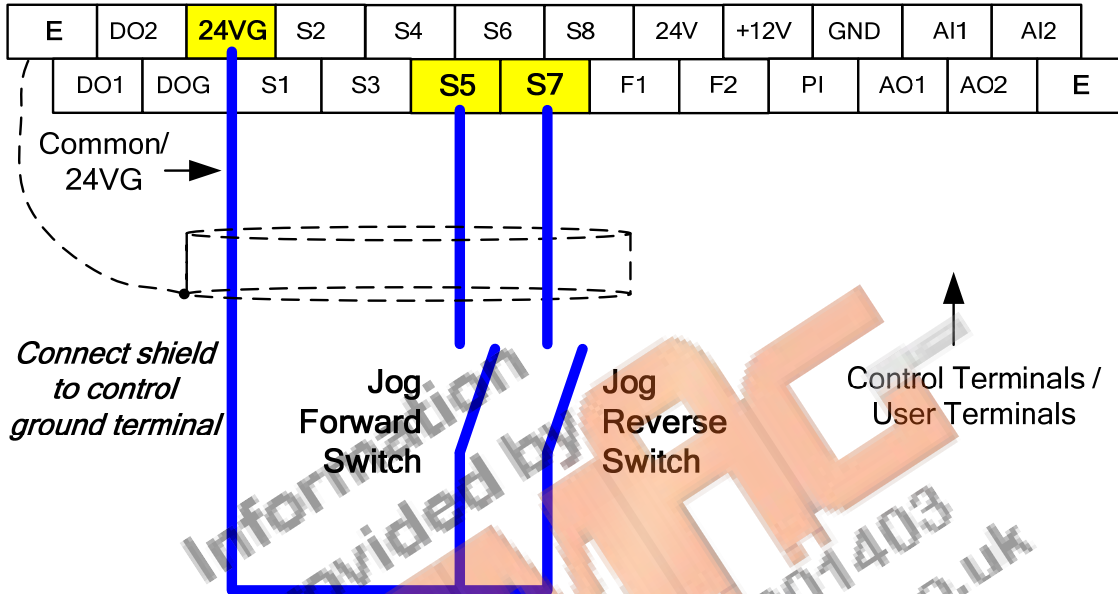

8.7 Direct / Unattended Startup

The unattended startup function prevents the inverter from starting automatically when a run command is present at time of power-up. To use USP command set one of the multi-function digital input functions to #50 (USP Startup).

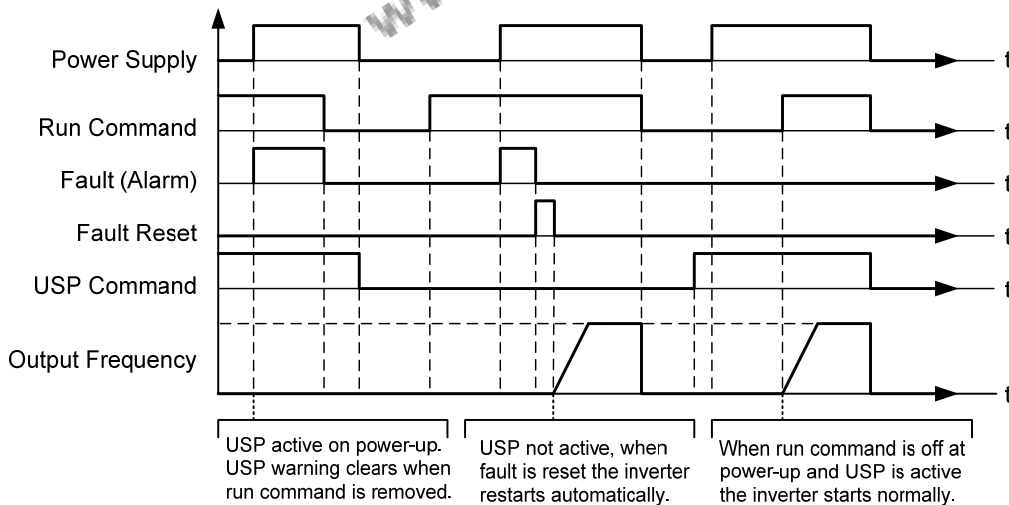

Unattended Startup Protection

8.8 Analog Output Setup

Signal: Use parameter 04-11 to select the analog output signal for AO1 and parameter 04-16 to select the analog output signal for AO2.

Gain: Use parameter 04-12 to adjust the gain for AO1 and parameter 04-17 to adjust the gain for AO2. Adjust the gain so that the analog output (10V) matches 100% of the selected analog output signal (04-11 for AO1 and 04-16 for AO2).

Bias: Use parameter 04-13 to adjust the bias for AO1 and parameter 04-18 to adjust the bias for AO2. Adjust the bias so that the analog output (0V) matches 0% of the selected analog output signal (04-11 for AO1 and 04-16 for AO2).

Example: Analog Output 1 Wiring

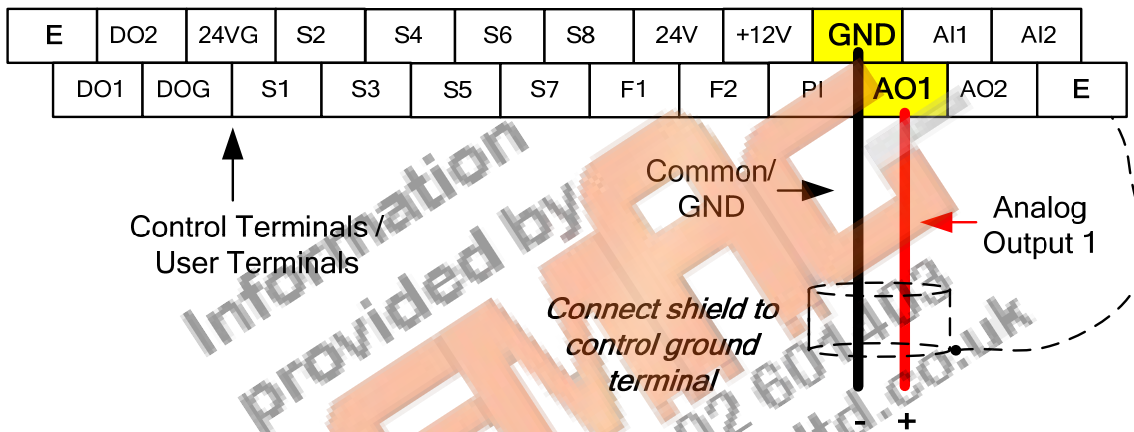

04-11	AO1 function Setting	
Range	0: Output frequency	14: Reserved
	1: Frequency command	15: ASR output
	2: Output voltage	16: Reserved
	3: DC voltage	17: q-axis voltage
	4: Output current	18: d-axis voltage
	5: Output power	19: Reserved
	6: Motor speed	20: Reserved
	7: Output power factor	21: PID input
	8: AI1 input	22: PID output
	9: AI2 input	23: PID target value
	10: Torque command	24: PID feedback value
	11: q -axis current	25: Output frequency of the soft starter
	12: d-axis current	26: PG feedback
	13: Speed deviation	27: PG compensation amount

04-12	AO1 gain
Range	0.0~1000.0%
04-13	AO1 bias
Range	-100.0~100.0%
04-16	AO2 function Setting
Range	See parameter 04-11
04-17	AO2 gain
Range	0.0~1000.0%
04-18	AO2 bias
Range	-100.0~100.0%

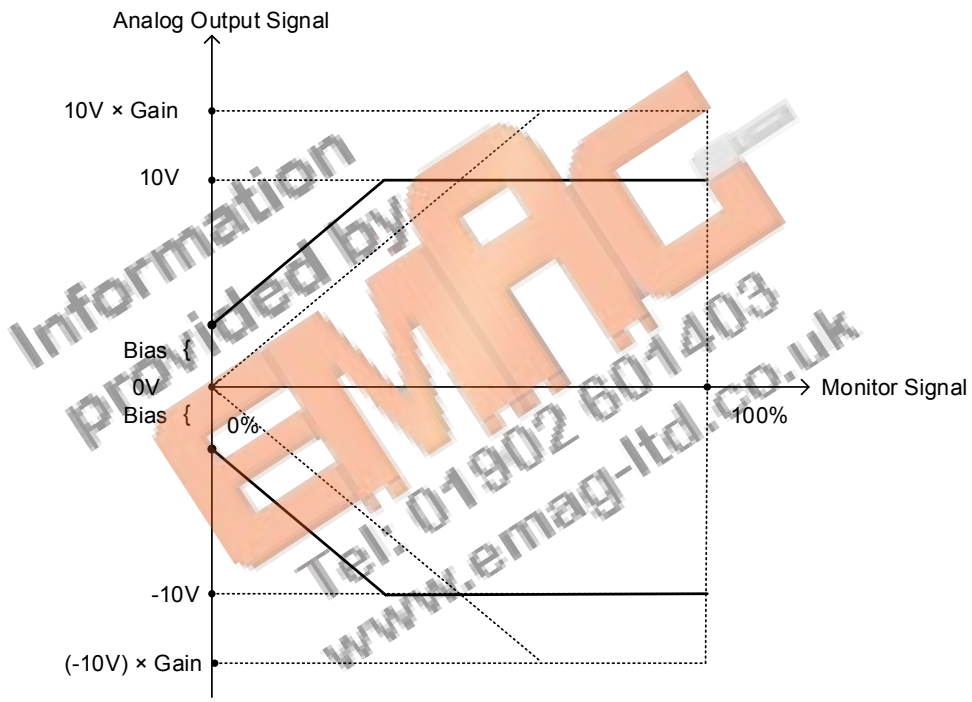

Analog output level adjustment

Chapter 9 Using PID Control for Constant Flow / Pressure Applications

9.1 What is PID Control?

The PID function in the inverter can be used to maintain a constant process variable such as pressure, flow, temperature by regulating the output frequency (motor speed). A feedback device (transducer) signal is used to compare the actual process variable to a specified setpoint. The difference between the set-point and feedback signal is called the error signal.

The PID control tries to minimize this error to maintain a constant process variable by regulating the output frequency (motor speed).

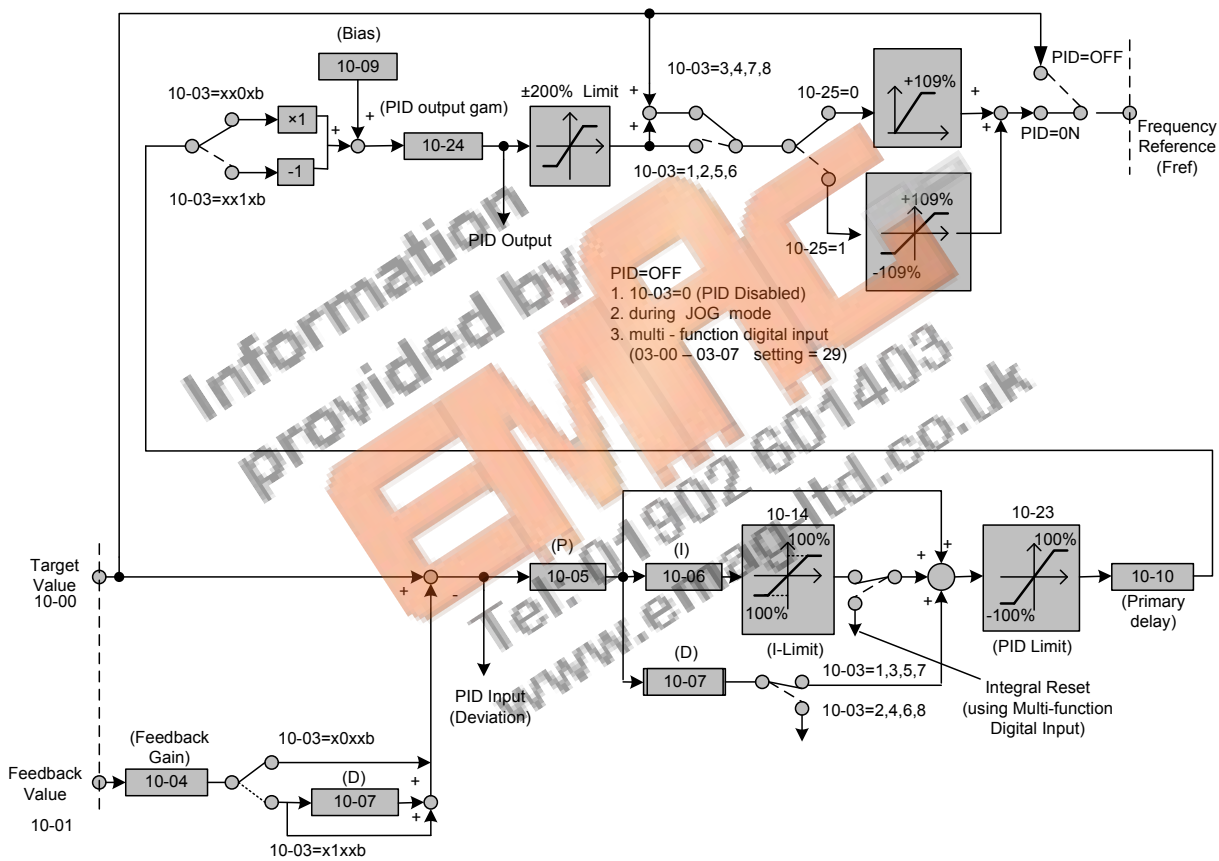

The amplitude of the error can be adjusted with the Proportional Gain parameter 10-05 and is directly related to the output of the PID controller, so the larger the gain the larger the output correction.

Example 1:

Gain = 1.0

Set-Point = 80%

Feedback = 78%

Error = Set-point - Feedback = 2%

Control Error = Gain x Error = 2%

Example 2:

Gain = 2.0

Set-Point = 80%

Feedback = 78%

Error = Set-point - Feedback = 2%

Control Error = Gain x Error = 4%

Please note that an excessive gain can make the system unstable and oscillation may occur.

The response time of the system can be adjusted with the Integral Gain set by parameter 10-06. Increasing the Integral Time will make the system less responsive and decreasing the Integral Gain Time will increase response but may result in instability of the total system.

Slowing the system down too much may be unsatisfactory for the process. The end result is that these two parameters in conjunction with the acceleration (00-14) and deceleration (00-15) times are adjusted to achieve optimum performance for a particular application.

For typical fan and pump applications a Proportional Gain (10-05) of 2.0 and an Integral Time (10-06) of 5.0 sec is recommended.

10-03 PID control mode

PID control can be enabled by setting parameter 10-03 to 'xxx1b'

10-03	PID control mode
Range	xxx0b: PID disable xxx1b: PID enable xx0xb: PID positive characteristic xx1xb: PID negative characteristic x0xxb: PID error value of D control x1xxb: PID feedback value of D control 0xxxb: PID output 1xxxb: PID output +target value

Commonly used PID control modes

0001b: Forward operation: PID operation enabled, motor speeds increases when feedback signal is smaller than set-point (most fan and pump applications)

0011b: Reverse operation: PID operation enabled, motor slows down when feedback signal is smaller than set-point (e.g. level control applications)

To set parameter 10-03:

- After power-up press the **DSP/FUN** key
- Set Group **10** (PID Control), and select parameter -03 with the **UP/DOWN ▲** and **▼** keys and press the **READ/ ENTER** key.

Important: To use the PID function parameter 00-05 (Main Frequency Command Source Selection) has to be set to 5 for PID reference.

9.2 Connect Transducer Feedback Signal (10-01)

The PID function in the inverter

Depending on the type of feedback transducer used, the inverter can be setup for either 0-10V or a 4-20mA feedback transducer.

Feedback Signal from AI2 (10-01 = 2), and set the input current to 4 – 20mA / SW2 = I

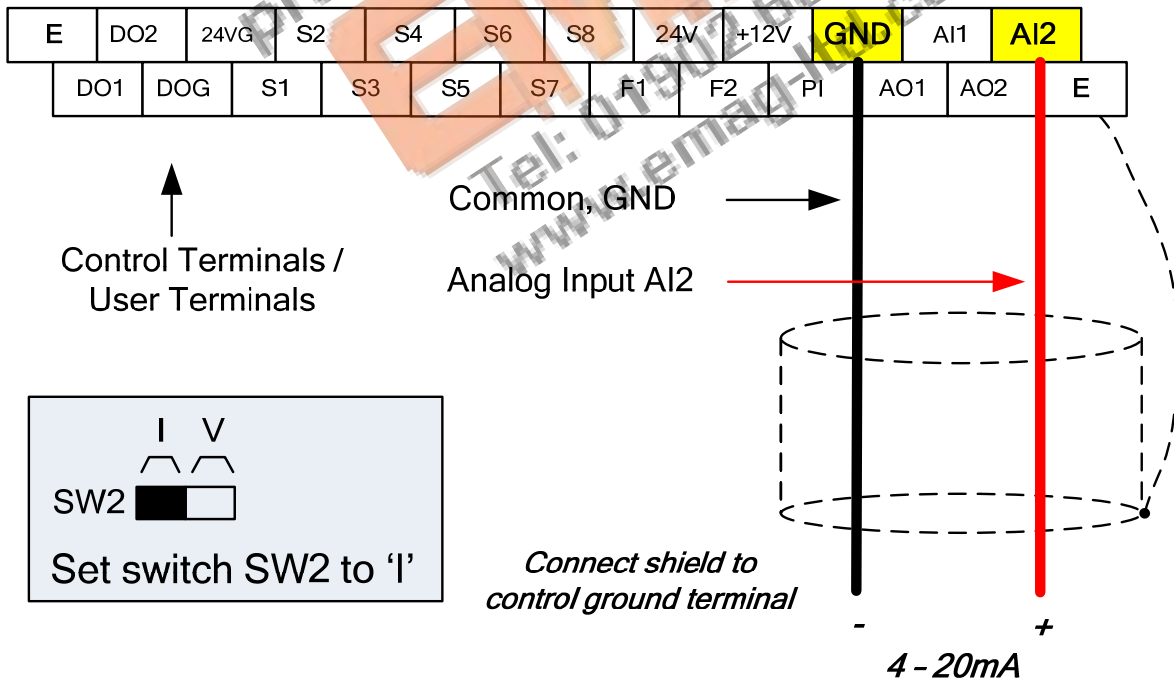

Feedback Signal from AI1 (10-01 = 1), and set the input voltage to 0 – 10V / SW2 = V

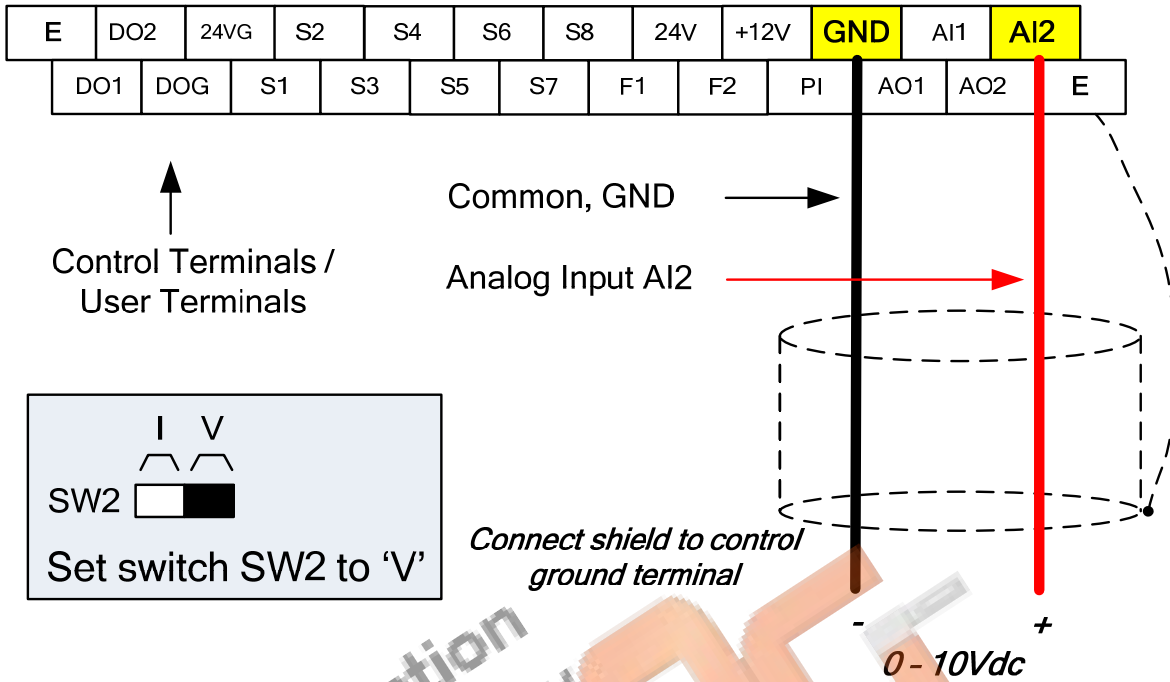

9.3 Engineering Units (only for LCD)

The PID setpoint scaling can be selected with parameter 16-03 and 16-04.

Example: 0 – 200.0 PSI Setpoint, set 16-03 to 12000 (1 decimal, range 0 – 200) and 16-04 to 2 (PSI).

9.4 Sleep / Wakeup Function

The PID Sleep function can be used to prevent a system from running at low speeds and is frequently used in pumping application. The PID Sleep function is turned on by parameter 10-29 set to 1. The inverter output turns off when the PID output falls below the PID sleep level (10-17) for the time specified in the PID sleep delay time parameter (10-18).

The inverter wakes up from a sleep condition when the PID output (Reference frequency) rises above the PID wake-up frequency (10-19) for the time specified in the PID wake-up delay time (10-20).

10-29 =0: PID Sleep function is disabled.

10-29 =1: PID sleep operation is based on parameters of 10-17 and 10-18.

10-29 =2: PID sleep mode is enabled by multi-function digital input

Refer to the following figures for PID sleep / wakeup operation.

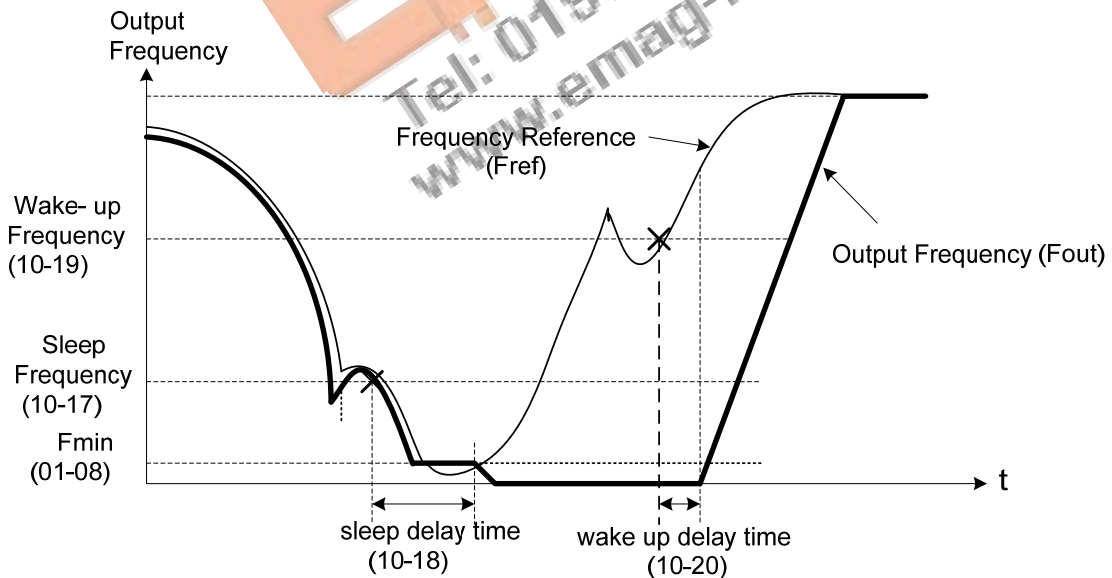
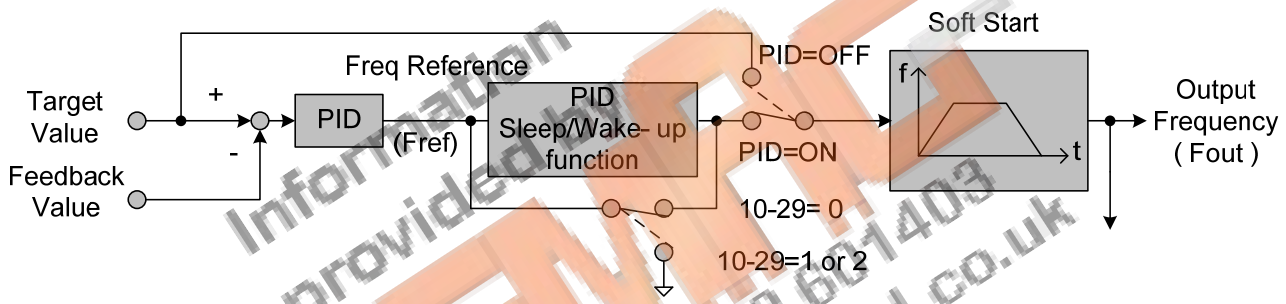

PID Sleep Function

Chapter 10 Troubleshooting and Fault Diagnostics

10.1 General

Inverter fault detection and early warning / self-diagnosis function. When the inverter detects a fault, a fault message is displayed on the keypad. The fault contact output energizes and the motor will coast to stop (The stop method can be selected for specific faults).

When the inverter detects a warning / self-diagnostics error, the digital operator will display a warning or self-diagnostic code, the fault output does not energize in this case. Once the warning is removed, the system will automatically return to its original state.

10.2 Fault Detection Function



When a fault occurs, please refer to Table 10.2.1 for possible causes and take appropriate measures.

Use one of the following methods to restart:

1. Set one of multi-function digital input terminals (03-00, 03-07) to 17 (Fault reset); activate input
2. Press the reset button on the keypad.
3. Power down inverter wait until keypad goes blank and power-up the inverter again.

When a fault occurs, the fault message is stored in the fault history (see group 12 parameters).

Table 10.2.1 Fault information and possible solutions



LED display	Description	Cause	Possible solutions
<p>OC over current</p> 	<p>The inverter output current exceeds the overcurrent level (200% of the inverter rated current).</p>	<ul style="list-style-type: none"> • Acceleration / Deceleration time is too short. • Contactor at the inverter output side. • A special motor or applicable capacity is greater than the inverter rated value. • Short circuit or ground fault. 	<ul style="list-style-type: none"> • Extend acceleration / deceleration time. • Check the motor wiring. • Disconnect motor and try running inverter.
<p>SC short circuit</p> 			
<p>GF Ground fault</p> 	<p>The current to ground exceeds 50% of the inverter rated output current (08-23 = 1, GF function is enabled).</p>	<ul style="list-style-type: none"> • Motor damaged (insulation). • Wire damage or deterioration. • Inverter DCCT sensors defect. 	<ul style="list-style-type: none"> • Replace motor. • Check the motor wiring. • Disconnect motor and try running inverter. • Check resistance between cables and ground. • Reduce carrier frequency.
<p>SC short circuit</p>			

LED display	Description	Cause	Possible solutions
OV Over voltage	DC bus voltage exceeds the OV detection level: 410Vdc: 200V class 20Vdc: 400V class (For 400V class, if input voltage 01-14 is set lower than 400V, the OV detection value will be decreased to 700Vdc).	<ul style="list-style-type: none"> Deceleration time set too short, resulting in regenerative energy flowing back from motor to the inverter. The inverter input voltage is too high. Use of power factor correction capacitors. Excessive braking load. Braking transistor or resistor defective. Speed search parameters set incorrectly. 	<ul style="list-style-type: none"> Increase deceleration time Reduce input voltage to comply with the input voltage requirements or install an AC line reactor to lower the input voltage. Remove the power factor correction capacitor. Use dynamic braking unit. Replace braking transistor or resistor. Adjust speed search parameters.
OU			
UV Under voltage	DC bus voltage is lower than the UV detection level or the pre-charge contactor is not active while the inverter is running. 190Vdc: 200V class; 380Vdc: 400V class (The detection value can be adjusted by 07-13).	<ul style="list-style-type: none"> The input voltage is too low. Input phase loss. Acceleration time set too short. Input voltage fluctuation. Pre-charge contactor damaged. DC bus voltage feedback signal value not correct. 	<ul style="list-style-type: none"> Check the input voltage. Check input wiring. Increase acceleration time. Check power source Replace pre-charge contactor Replace control board or complete inverter.
UU			
IPL input phase loss	Phase loss at the input side of the inverter or input voltage imbalance, active when 08-09 = 1 (enabled).	<ul style="list-style-type: none"> Wiring loose in inverter input terminal. Momentary power loss. Input voltage imbalance. 	<ul style="list-style-type: none"> Check input wiring / faster screws. Check power supply.
IPL			
OPL output phase loss	Phase loss at the output side of the inverter, active when 08-10 = 1 (enabled).	<ul style="list-style-type: none"> Wiring loose in inverter output terminal. Motor rated current is less than 10% of the inverter rated current. 	<ul style="list-style-type: none"> Check output wiring / faster screws. Check motor & inverter rating.
OPL			
OH1 Heatsink overheat	The temperature of the heat sink is too high. Note: when OH1 fault occurs three times within five minutes, it is required to wait 10 minutes before resetting the fault.	<ul style="list-style-type: none"> Ambient temperature too high. cooling fan failed Carrier frequency set too high. Load too heavy. 	<ul style="list-style-type: none"> Install fan or AC to cool surroundings. Replace cooling fan. Reduce carrier frequency. Reduce load / Measure output current
OH1			
OL1 Motor overload	Internal motor overload protection tripped, active when protection curve 08-05 = xxx1.	<ul style="list-style-type: none"> Voltage setting V/F mode too high, resulting in over-excitation of the motor. Motor rated current (02-01) set incorrectly. Load too heavy. 	<ul style="list-style-type: none"> Check V/f curve. Check motor rated current Check and reduce motor load, check and operation duty cycle.
OL1			

LED display	Description	Cause	Possible solutions																	
OL2 Inverter overload	Inverter thermal overload protection tripped. If an inverter overload occurs 4 times in five minutes, it is required to wait 4 minutes before resetting the fault.	<ul style="list-style-type: none"> • Voltage setting V/F mode too high, resulting in over-excitation of the motor. • Inverter rating too small. • Load too heavy. 	<ul style="list-style-type: none"> • Check V/f curve. • Replace inverter with larger rating. • Check and reduce motor load, check and operation duty cycle. 																	
OL2				OT Over torque detection	Inverter output torque is higher than 08-15 (over torque detection level) for the time specified in 08-16. Parameter 08-14 = 0 to activate.	<ul style="list-style-type: none"> • Load too heavy. 	<ul style="list-style-type: none"> • Check over torque detection parameters (08-15 / 08-16). • Check and reduce motor load, check and operation duty cycle. 	OT	UT Under torque detection	Inverter output torque is lower than 08-19 (under torque detection level) for the time specified in 08-20. Parameter 08-18 = 0 to activate.	<ul style="list-style-type: none"> • Sudden drop in load. • Belt break. 	<ul style="list-style-type: none"> • Check under torque detection parameters (08-19 / 08-20). • Check load / application. 	UT	CLB Current Protection Level B	Inverter current reaches the current protection level B.	<ul style="list-style-type: none"> • Inverter current too high. • Load too heavy. 	<ul style="list-style-type: none"> • Check load and duty cycle operation. 	CLB	OS Over speed	Motor speed exceeds level set in 20-20 (PG Over speed Level) for the time set in 20-21 (PG over speed time). Active when 20-19 (= 0 or 1). This fault is active V/F + PG and SV control mode (00-00 = 1 or 3 or 4). Motor speed can be monitored by 12-22
OT Over torque detection	Inverter output torque is higher than 08-15 (over torque detection level) for the time specified in 08-16. Parameter 08-14 = 0 to activate.	<ul style="list-style-type: none"> • Load too heavy. 	<ul style="list-style-type: none"> • Check over torque detection parameters (08-15 / 08-16). • Check and reduce motor load, check and operation duty cycle. 																	
OT				UT Under torque detection	Inverter output torque is lower than 08-19 (under torque detection level) for the time specified in 08-20. Parameter 08-18 = 0 to activate.	<ul style="list-style-type: none"> • Sudden drop in load. • Belt break. 	<ul style="list-style-type: none"> • Check under torque detection parameters (08-19 / 08-20). • Check load / application. 	UT	CLB Current Protection Level B	Inverter current reaches the current protection level B.	<ul style="list-style-type: none"> • Inverter current too high. • Load too heavy. 	<ul style="list-style-type: none"> • Check load and duty cycle operation. 	CLB	OS Over speed	Motor speed exceeds level set in 20-20 (PG Over speed Level) for the time set in 20-21 (PG over speed time). Active when 20-19 (= 0 or 1). This fault is active V/F + PG and SV control mode (00-00 = 1 or 3 or 4). Motor speed can be monitored by 12-22	<ul style="list-style-type: none"> • Motor speed overshoot (ASR) • PG ppr set incorrectly. • Overspeed parameters set incorrectly. 	<ul style="list-style-type: none"> • Check ASR parameters group 21. • Check PG parameters • Check overspeed parameters 20-20/20-12. 	OS		
UT Under torque detection	Inverter output torque is lower than 08-19 (under torque detection level) for the time specified in 08-20. Parameter 08-18 = 0 to activate.	<ul style="list-style-type: none"> • Sudden drop in load. • Belt break. 	<ul style="list-style-type: none"> • Check under torque detection parameters (08-19 / 08-20). • Check load / application. 																	
UT				CLB Current Protection Level B	Inverter current reaches the current protection level B.	<ul style="list-style-type: none"> • Inverter current too high. • Load too heavy. 	<ul style="list-style-type: none"> • Check load and duty cycle operation. 	CLB	OS Over speed	Motor speed exceeds level set in 20-20 (PG Over speed Level) for the time set in 20-21 (PG over speed time). Active when 20-19 (= 0 or 1). This fault is active V/F + PG and SV control mode (00-00 = 1 or 3 or 4). Motor speed can be monitored by 12-22	<ul style="list-style-type: none"> • Motor speed overshoot (ASR) • PG ppr set incorrectly. • Overspeed parameters set incorrectly. 	<ul style="list-style-type: none"> • Check ASR parameters group 21. • Check PG parameters • Check overspeed parameters 20-20/20-12. 	OS							
CLB Current Protection Level B	Inverter current reaches the current protection level B.	<ul style="list-style-type: none"> • Inverter current too high. • Load too heavy. 	<ul style="list-style-type: none"> • Check load and duty cycle operation. 																	
CLB				OS Over speed	Motor speed exceeds level set in 20-20 (PG Over speed Level) for the time set in 20-21 (PG over speed time). Active when 20-19 (= 0 or 1). This fault is active V/F + PG and SV control mode (00-00 = 1 or 3 or 4). Motor speed can be monitored by 12-22	<ul style="list-style-type: none"> • Motor speed overshoot (ASR) • PG ppr set incorrectly. • Overspeed parameters set incorrectly. 	<ul style="list-style-type: none"> • Check ASR parameters group 21. • Check PG parameters • Check overspeed parameters 20-20/20-12. 	OS												
OS Over speed	Motor speed exceeds level set in 20-20 (PG Over speed Level) for the time set in 20-21 (PG over speed time). Active when 20-19 (= 0 or 1). This fault is active V/F + PG and SV control mode (00-00 = 1 or 3 or 4). Motor speed can be monitored by 12-22	<ul style="list-style-type: none"> • Motor speed overshoot (ASR) • PG ppr set incorrectly. • Overspeed parameters set incorrectly. 	<ul style="list-style-type: none"> • Check ASR parameters group 21. • Check PG parameters • Check overspeed parameters 20-20/20-12. 																	
OS																				

LED display	Description	Cause	Possible solutions
PGO PG Open circuit	PG pulses are not received by the inverter for the time specified in 20-26 (PG open circuit detection time). This fault is active V/F + PG and SV control mode (00-00 = 1 or 3 or 4).	<ul style="list-style-type: none"> PG cable disconnected. PG has no power. Mechanical brake active preventing motor from turning. 	<ul style="list-style-type: none"> Check PG wiring. Check PG power-supply. Make sure brake is released.
PGO			
DEV Speed deviation	Motor speed rises above 20-23 level (PG speed deviation level) for the time specified in 20-24 (PG deviation time)...Active when parameter 20-22(=0 or 1). This fault is active V/F + PG and SV control mode (00-00 = 1 or 3 or 4).	<ul style="list-style-type: none"> Load too heavy Mechanical brake active preventing motor from turning. PG wiring error. PG parameters (group 20) set incorrectly. Acceleration / deceleration time set to short. 	<ul style="list-style-type: none"> Check load Make sure brake is released. Check PG wiring. Check PG parameters 20-23/20-24. Increase Acceleration / deceleration time.
DEV			
CE communication error	No Modbus communication received in for the time specified in 09-06 (communication error detection time). Active when 09-07(= 0 to 2).	<ul style="list-style-type: none"> Connection lost or wire broken. Host stopped communicating. 	<ul style="list-style-type: none"> Check connection Check host computer / software.
CE			
FB PID feedback loss	PID feedback signal falls below level specified in 10-12 (PID feedback loss detection level) for the time specified in 10-13 (Feedback loss detection time). Active when parameter (10-11 = 2).	<ul style="list-style-type: none"> Feedback signal wire broken Feedback sensor broken. 	<ul style="list-style-type: none"> Check feedback wiring Replace feedback sensor.
Fb			
STO Safety switch	Inverter safety switches open.	<ul style="list-style-type: none"> Terminal board Input F1 and F2 are not connected 	<ul style="list-style-type: none"> Check F1 and F2 connection
STO			

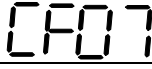
LED display	Description	Possible causes	Corrective action
EF1 External fault (S1) EF1	External fault (Terminal S1) Active when 03-00= 25, and Inverter external fault selection 08-24=0 or 1.	<ul style="list-style-type: none"> • Multifunction digital input external fault active. 	<ul style="list-style-type: none"> • Multi-function input function set incorrectly. • Check wiring
EF2 External fault (S2) EF2	External fault (Terminal S2) Active when 03-01= 25, and Inverter external fault selection 08-24=0 or 1.		
EF3 External fault (S3) EF3	External fault (Terminal S3) Active when 03-02= 25, and Inverter external fault selection 08-24=0 or 1.		
EF4 External fault (S4) EF4	External fault (Terminal S4) Active when 03-03= 25, and Inverter external fault selection 08-24=0 or 1.		
EF5 External fault (S5) EF5	External fault (Terminal S5) Active when 03-04= 25, and Inverter external fault selection 08-24=0 or 1.		
EF6 External fault (S6) EF6	External fault (Terminal S6) Active when 03-05= 25, and Inverter external fault selection 08-24=0 or 1.		
EF7 External fault (S7) EF7	External fault (Terminal S7) Active when 03-06= 25, and Inverter external fault selection 08-24=0 or 1.		
EF8 External fault (S8) EF8	External fault (Terminal S8) Active when 03-07= 25, and Inverter external fault selection 08-24=0 or 1.		

LED display	Description	Possible causes	Corrective action
CF07 Motor control fault 	Motor control fault	<ul style="list-style-type: none"> • SLV mode is unable to run motor. 	<ul style="list-style-type: none"> • Perform rotational or stationary auto-tune • Increase minimum output frequency (01-08)
FU fuse open 	DC bus fuse blown DC fuse (Models 200V 50HP and above, 400V 75HP and above) open circuit.	<ul style="list-style-type: none"> • IGBT damaged. • Short circuit output terminals. 	<ul style="list-style-type: none"> • Check IGBTs • Check for short circuit at inverter output. • Replace inverter.
CF00 Operator Communication Error LCD display only*	Errors of data transmission occur in LCD keypad	<ul style="list-style-type: none"> • LCD keypad and inverter cannot transmit data after power on 5 seconds 	<ul style="list-style-type: none"> • Disconnect the operator and then reconnect. • Replace the control board
CF01 Operator Communication Error 2 LCD display only*	Errors of data transmission occur in LCD keypad	<ul style="list-style-type: none"> • LCD keypad and inverter can transmit data but transmission error occurs for more than 2 seconds 	<ul style="list-style-type: none"> • Disconnect the operator and then reconnect. • Replace the control board

* When the communication errors occur in LED keypad, the LED will stay the screen and stop action.

Information provided by
EMAG
Tel: 01902 601403
www.emag-ltd.co.uk

10.3 Warning / Self-diagnosis Detection Function

When the inverter detects a warning, the keypad displays a warning code (flash).

Note: The fault contact output does not energize on a warning and the inverter continues operation. When the warning is no longer active the keypad will return to its original state.



When the inverter detected a programming error (for example two parameters contradict each other or are set to an invalid setting), the keypad displays a self-diagnostics code.







Note: The fault contact output does not energize on a self-diagnostics error. While a self-diagnostics code is active the inverter does not accept a run command until the programming error is corrected.





Note: When a warning or self-diagnostic error is active the warning or error code will flash on the keypad. When the RESET key is pressed, the warning message (flash) disappears and returns after 5 sec. If the warning or self-diagnostic error still exists.

Refer to Table 10.3.1 for an overview, cause and corrective action for inverter warnings and self-diagnostic errors.



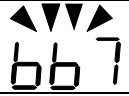
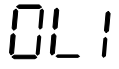

Table 10.3.1 warning / self-diagnosis and corrective actions





LED display	Description	Possible causes	Corrective action
OV (flash) Over voltage 	DC bus voltage exceeds the OV detection level: 410Vdc: 200V class 820Vdc: 400V class (for 440V class, if input voltage 01-14 is set lower than 400V, the OV detection value will be decreased to 700Vdc)	<ul style="list-style-type: none"> Deceleration time set too short, resulting in regenerative energy flowing back from motor to the inverter. The inverter input voltage is too high. Use of power factor correction capacitors. Excessive braking load. Braking transistor or resistor defective. Speed search parameters set incorrectly. 	<ul style="list-style-type: none"> Increase deceleration time Reduce input voltage to comply with the input voltage requirements or install an AC line reactor to lower the input voltage. Remove the power factor correction capacitor. Use dynamic braking unit. Replace braking transistor or resistor. Adjust speed search parameters.
UV (flash) under voltage 	DC bus voltage is lower than the UV detection level or the pre-charge contactor is not active while the inverter is running. 190Vdc: 200V class; 380Vdc: 400V class (the detection value can be adjusted by 07-13)	<ul style="list-style-type: none"> The input voltage is too low. Input phase loss. Acceleration time set too short. Input voltage fluctuation. Pre-charge contactor damaged. DC bus voltage feedback signal value not correct. 	<ul style="list-style-type: none"> Check the input voltage. Check input wiring. Increase acceleration time. Check power source Replace pre-charge contactor Replace control board or complete inverter.







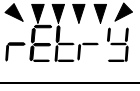

LED display	Description	Possible causes	Corrective action
OH2 (flash) Inverter over heating warning 	Inverter overheat warning Multi-function digital input set to 32. (Terminal S1 ~ S8) Active when 03-00 ~ 03-07 = 31).	<ul style="list-style-type: none"> • Multifunction digital input overheat warning active. 	<ul style="list-style-type: none"> • Multi-function input function set incorrectly. • Check wiring
OT (flash) over torque detection 	Inverter output torque is higher than 08-15 (over torque detection level) for the time specified in 08-16. Parameter 08-14 = 0 to activate.	<ul style="list-style-type: none"> • Load too heavy. 	<ul style="list-style-type: none"> • Check over torque detection parameters (08-15 / 08-16). • Check and reduce motor load, check and operation duty cycle.
UT (flash) under torque detection 	Inverter output torque is lower than 08-19 (under torque detection level) for the time specified in 08-20. Parameter 08-18 = 0 to activate.	<ul style="list-style-type: none"> • Sudden drop in load. • Belt break. 	<ul style="list-style-type: none"> • Check under torque detection parameters (08-19 / 08-20). • Check load / application.
bb1 (flash) External baseblock 	External base block (Terminal S1)	<ul style="list-style-type: none"> • Multifunction digital input external baseblock active. 	<ul style="list-style-type: none"> • Multi-function input function set incorrectly. • Check wiring
bb2 (flash) External baseblock 	External base block (Terminal S2)		
bb3 (flash) External baseblock 	External base block (Terminal S3)		
bb4 (flash) External baseblock 	External base block (Terminal S4)		





LED display	Description	Possible causes	Corrective action
bb5 (flash) External baseblock 	External base block (Terminal S5)	<ul style="list-style-type: none"> • Multifunction digital input external baseblock active. 	<ul style="list-style-type: none"> • Multi-function input function set incorrectly. • Check wiring
bb6 (flash) External baseblock 	External base block (Terminal S6)		
bb7 (flash) External baseblock 	External base block (Terminal S7)		
bb8 (flash) External baseblock 	External base block (Terminal S8)		







Information provided by **EMAG**
Tel: 01902 601403
www.emag-ltd.co.uk

LED display	Description	Possible causes	Corrective action
OS (flash) Motor over speed	Motor speed exceeds level set in 20-20 (PG Over speed Level) for the time set in 20-21 (PG over speed time). Active when 20-19 (= 0 or 1). This fault is active V/F + PG and SV control mode (00-00 = 1 or 3 or 4). Motor speed can be monitored by 12-22	<ul style="list-style-type: none"> • Motor speed overshoot (ASR) • PG ppr set incorrectly. • Overspeed parameters set incorrectly. 	<ul style="list-style-type: none"> • Check ASR parameters group 21. • Check PG parameters • Check overspeed parameters 20-20/20-12.
			
PGO (flash) PG open circuit	PG pulses are not received by the inverter for the time specified in 20-26 (PG open circuit detection time). This fault is active V/F + PG and SV control mode (00-00 = 1 or 3 or 4).	<ul style="list-style-type: none"> • PG cable disconnected. • PG has no power. • Mechanical brake active preventing motor from turning. 	<ul style="list-style-type: none"> • Check PG wiring. • Check PG power-supply. • Make sure brake is released.
			
DEV (flash) Speed deviation	Motor speed rises above 20-23 level (PG speed deviation level) for the time specified in 20-24 (PG deviation time). Active when parameter 20-22(=0 or 1). This fault is active V/F + PG and SV control mode (00-00 = 1 or 3 or 4).	<ul style="list-style-type: none"> • Load too heavy • Mechanical brake active preventing motor from turning. • PG wiring error. • PG parameters (group 20) set incorrectly. • Acceleration / deceleration time set to short. 	<ul style="list-style-type: none"> • Check load • Make sure brake is released. • Check PG wiring. • Check PG parameters 20-23/20-24. • Increase Acceleration / deceleration time.
			
OL1 Motor overload	Internal motor overload protection tripped, active when protection curve 08-05 = xxx1.	<ul style="list-style-type: none"> • Voltage setting V/F mode too high, resulting in over-excitation of the motor. • Motor rated current (02-01) set incorrectly. • Load too heavy. 	<ul style="list-style-type: none"> • Check V/f curve. • Check motor rated current • Check and reduce motor load, check and operation duty cycle.
			
OL2 Inverter overload	Inverter thermal overload protection tripped. If an inverter overload occurs 4 times in five minutes, it is required to wait 4 minutes before resetting the fault.	<ul style="list-style-type: none"> • Voltage setting V/F mode too high, resulting in over-excitation of the motor. • Inverter rating too small. • Load too heavy. 	<ul style="list-style-type: none"> • Check V/f curve. • Replace inverter with larger rating. • Check and reduce motor load, check and operation duty cycle.
			

LED display	Description	Possible causes	Corrective action
CE (flash) communicati on error 	No Modbus communication received for 2 sec. Active when 09-07=3.	<ul style="list-style-type: none"> • Connection lost or wire broken. • Host stopped communicating. 	<ul style="list-style-type: none"> • Check connection • Check host computer / software.
CLA over current protection level A 	Inverter current reaches the current protection level A.	<ul style="list-style-type: none"> • Inverter current too high. • Load too heavy. 	<ul style="list-style-type: none"> • Check load and duty cycle operation.
CLB over current protection level B 	Inverter current reaches the current protection level B.	<ul style="list-style-type: none"> • Inverter current too high. • Load too heavy. 	<ul style="list-style-type: none"> • Check load and duty cycle operation.
ADL current feedback protection level 	Inverter current reaches the current feedback protection level.	<ul style="list-style-type: none"> • Inverter current too high. • Load too heavy. 	<ul style="list-style-type: none"> • Check load and duty cycle operation.
Retry (flash) retry 	Automatic reset activated, warning is displayed until restart delay time set (07-01) expires.	<ul style="list-style-type: none"> • Parameter 07-01 set to a value greater than 0. • Parameter 07-02 set to a value greater than 0. 	<ul style="list-style-type: none"> • Warning disappears after automatic reset.

LED display	Description	Possible causes	Corrective action
EF1 (flash) External fault (S1) 	External fault (Terminal S1) Active when 03-00=25, and Inverter external fault selection 08-24=2.		
EF2 (flash) External fault (S2) 	External fault (Terminal S2) Active when 03-01=25, and Inverter external fault selection 08-24=2.		
EF3 (flash) External fault (S3) 	External fault (Terminal S3) Active when 03-02=25, and Inverter external fault selection 08-24=2.		
EF4 (flash) External fault (S4) 	External fault (Terminal S4) Active when 03-03=25, and Inverter external fault selection 08-24=2.	<ul style="list-style-type: none"> • Multifunction digital input external fault active and parameter 08-24 = 2 for operation to continue. 	<ul style="list-style-type: none"> • Multi-function input function set incorrectly. • Check wiring
EF5 (flash) External fault (S5) 	External fault (Terminal S5) Active when 03-04=25, and Inverter external fault selection 08-24=2.		<ul style="list-style-type: none"> • Multi-function input function set incorrectly. • Check wiring
EF6 (flash) External fault (S6) 	External fault (Terminal S6) Active when 03-05=25, and Inverter external fault selection 08-24=2.		
EF7 (flash) External fault (S7) 	External fault (Terminal S7) Active when 03-06=25, and Inverter external fault selection 08-24=2.		
EF8 (flash) External fault (S8) 	External fault (Terminal S8) Active when 03-07=25, and Inverter external fault selection 08-24=2.		

LED display	Description	Possible causes	Corrective action
EF9 (flash) error of forward/reversal rotation 	Forward run and reverse run are active within 0.5 sec of each other. Stop method set by parameter 07-09.	<ul style="list-style-type: none"> • Forward run and reverse run active (see 2-wire control). 	<ul style="list-style-type: none"> • Check run command wiring
SE01 Rang setting error 	Parameter setting falls outside the allowed range.	<ul style="list-style-type: none"> • Some parameter ranges are determined by other inverter parameters which could cause an out of range warning when the dependency parameter is adjusted. Example: 02-00 > 02-01, 02-20 > 02-21, 00-12 > 00-13 etc...). 	<ul style="list-style-type: none"> • Check parameter setting.
SE02 Digital input terminal error 	Multi-function input setting error.	<ul style="list-style-type: none"> • Multi-function digital input terminals (03-00 to 03-07) are set to the same function (not including ext. fault and not used.) or ①UP/DOWN commands are not set at the same time(they must be used together). ②UP/DOWN commands (08 and 09) and ACC/DEC commands (11) are set at the same time. ③Speed search 1(19, maximum frequency) and Speed search 2 (34, from the set frequency) are set at the same time. 	<ul style="list-style-type: none"> • Check multi-function input setting.
SE03 V/f curve error 	V/f curve setting error.	<ul style="list-style-type: none"> • V/F curve setting error. ① 01-02 > 01-12 > 01-06 > 01-08; • (Fmax) (Fbase) (Fmid1) (Fmin) ②01-16 > 01-24 > 01-20 > 01-22; • (Fmax2) (Fbase2)(Fmid1) (Fmin2) 	<ul style="list-style-type: none"> • Check V/F parameters
SE05 PID selection error 	PID selection error.	<ul style="list-style-type: none"> • 10-00 and 10-01 are set to the same analog input 1 (AI1) or 2 (AI2) 	<ul style="list-style-type: none"> • Check parameters 10-00 and 10-01.

LED display	Description	Possible causes	Corrective action
HPerr Model selection error 	Inverter capacity setting error: Inverter capacity setting 13-00 does not match the rated voltage.	<ul style="list-style-type: none"> • Inverter capacity setting does not match voltage class (13-00). 	<ul style="list-style-type: none"> • Check inverter capacity setting 13-00.
SE07 PG card error 	Inverter PG card setting error.	<ul style="list-style-type: none"> • No PG feedback card installed. 	<ul style="list-style-type: none"> • Install PG feedback card. • Check control mode.
SE08 PM Motor mode error 	Inverter rating does not support the PM Motor mode.	<ul style="list-style-type: none"> • Inverter rating does not support PM motor control mode. 	<ul style="list-style-type: none"> • Check control mode.
SE09 PI setting error 	Inverter PI setting error	<ul style="list-style-type: none"> • Inverter pulse input selection (03-30) selection conflicts with PID source (10-00 and 10-01). 	<ul style="list-style-type: none"> • Check pulse input selection (03-30) and PID source (10-00 and 10-01).
FB (flash) PID feedback breaking 	PID feedback signal falls below level specified in 10-12 (PID feedback loss detection level) for the time specified in 10-13 (Feedback loss detection time). Active when parameter (10-11 = 1).	<ul style="list-style-type: none"> • Feedback signal wire broken • Feedback sensor broken. 	<ul style="list-style-type: none"> • Check feedback wiring • Replace feedback sensor.
USP (flash) Unattended Start Protection 	Unattended Start Protection (USP) is enabled (enabled at power-up.)	<ul style="list-style-type: none"> • USP at power-up (activated by multi-function digital input) is enabled. The inverter will not accept a run command. • While the warning is active the inverter does not accept a run command. (See parameter 03-00 - 03-08 = 50). 	<ul style="list-style-type: none"> • Remove run command or reset inverter via multi-function digital input (03-00 to 03-07 = 17) or use the RESET key on the keypad to reset inverter. • Activate USP input and re-apply the power.

10.4 Auto-tuning Error

When a fault occurs during auto-tuning of a standard AC motor, the display will show the “AtErr” fault and the motor stops. The fault information is displayed in parameter 17-11.

Note: The fault contact output does not energize with an auto-tuning fault. Refer to Table 10.4.1, for fault information during tuning, cause and corrective action.

Table 10.4.1 Auto-tuning fault and corrective actions

Error	Description	Cause	Corrective action
01	Motor data input error.	<ul style="list-style-type: none"> Motor Input data error during auto-tuning. Inverter output current does not match motor rated current. 	<ul style="list-style-type: none"> Check the motor tuning data (17-00 to 17-09). Check inverter capacity
02	Motor lead to lead resistance R1 tuning error.	<ul style="list-style-type: none"> Auto-tuning is not completed within the specified time Auto-tuning results fall outside parameter setting range. Motor rated current exceeded. Motor was disconnected. 	<ul style="list-style-type: none"> Check the motor tuning data (17-00 to 17-09). Check motor connection. Disconnect motor load. Check inverter current detection circuit and DCCTs. Check motor installation.
03	Motor leakage inductance tuning error.		
04	Motor rotor resistance R2 tuning error.		
05	Motor mutual inductance Lm tuning error.		
07	Deadtime compensation detection error		
06	Motor encoder error	<ul style="list-style-type: none"> PG feedback noise 	<ul style="list-style-type: none"> Check motor rated current. Check PG card grounding.
08	Motor acceleration error (Rotational type auto-tuning only).	<ul style="list-style-type: none"> Motor fails to accelerate in the specified time (00-14=20sec). 	<ul style="list-style-type: none"> Increase acceleration time (00-14). Disconnect motor load.
09	Other	<ul style="list-style-type: none"> No load current is higher than 70% of the motor rated current. Torque reference exceeds 100%. Errors other than ATE01~ATE08. 	<ul style="list-style-type: none"> Check the motor tuning data (17-00 to 17-09). Check motor connection.

10.5 PM Motor Auto-tuning Error

When a fault occurs during auto-tuning of a PM motor, the display will show the “IPErr” fault and the motor stops. The fault information is displayed in parameter 22-18.

Note: The fault contact output does not energize with an auto-tuning fault. Refer to Table 10.5.1, for fault information during tuning, cause and corrective action.

Table 10.5.1 Auto-tuning fault and corrective actions for PM motor

Error	Description	Cause	Corrective action
01	Magnetic pole alignment tuning failure (static).	<ul style="list-style-type: none"> Inverter output current does not match motor current. 	<ul style="list-style-type: none"> Check the motor tuning data (22-02). Check inverter capacity
02	PG option missing.	<ul style="list-style-type: none"> Magnetic pole cannot be aligned without PG option card. 	<ul style="list-style-type: none"> Install PG feedback card.
03	Magnetic pole alignment auto-tuning abort during rotational auto-tune.	<ul style="list-style-type: none"> System abnormality during magnetic pole alignment. 	<ul style="list-style-type: none"> Check for active protection functions preventing auto-tuning.
04	Timeout during magnetic pole alignment during rotational auto-tune.	<ul style="list-style-type: none"> Motor cannot rotate 	<ul style="list-style-type: none"> Check motor. Check motor wiring. Check brake released.
05	Circuit tuning time out.	<ul style="list-style-type: none"> System abnormality during circuit tuning. 	<ul style="list-style-type: none"> Check for active protection functions preventing auto-tuning.
06	Encoder error	<ul style="list-style-type: none"> PG feedback noise 	<ul style="list-style-type: none"> Check motor rated current. Check PG card grounding.
07	Other motor tuning errors.	<ul style="list-style-type: none"> Other tuning errors. 	<ul style="list-style-type: none"> Check the motor tuning data (22-02). Check motor connection.
08	Motor current out of range during magnetic pole alignment (rotational auto-tune).	<ul style="list-style-type: none"> Motor cannot operate at low speeds. 	<ul style="list-style-type: none"> Check PG card wiring Check motor connection.
09	Current out of range during circuit tuning.	<ul style="list-style-type: none"> Inverter output current does not match motor current. 	<ul style="list-style-type: none"> Check the motor tuning data (22-02). Check inverter capacity
10	Magnetic pole alignment and circuit tuning failed.	<ul style="list-style-type: none"> Auto-tuning is not successful. 	<ul style="list-style-type: none"> Retry magnetic pole alignment and circuit tuning.

Chapter 11 Inverter Peripheral devices and Options

11.1 Braking Resistors and Braking Units

Inverters ratings 200V 1 ~ 25HP / 400V 1 ~ 30HP have a built-in braking transistor. For applications requiring a greater braking torque an external braking resistor can be connected to terminals B1 / P and B2; for inverter ratings above 200V 30HP / 400V 40HP, an external braking unit (connected to ⊕ - ⊖ of the inverter) and a braking resistor (connected to two ends of the detection module B-P0) is required.

Table 11.1.1 List of braking resistors and braking units

Inverter			Braking unit		Braking resistor				Braking torque (Peak / Continues)	Minimum Resistance ^{*1}
Input Voltage	HP	Rated Current (A) HD/ND	Model	Qty Req.	Part Number	Resistor specification	Qty Req.	Resistor dimensions (L*W*H) mm		
200V 1Ø/ 3Ø	1	5/6	-	-	JNBR-150W200	150W/200Ω	1	251*27*60	119%, 10%ED	60Ω
	2	8/9.6	-	-	JNBR-150W100	150W/100Ω	1	251*27*60	119%,10%ED	50Ω
	3	11/12	-	-	JNBR-260W70	260W/70Ω	1	274*34*78	115%,10%ED	25Ω
200V 3Ø	5	17.5/21	-	-	JNBR-390W40	390W/40Ω	1	395*34*78	119%,10%ED	21Ω
	7.5	25/30	-	-	JNBR-520W30	520W/30Ω	1	400*40*100	108%,10%ED	18Ω
	10	33/40	-	-	JNBR-780W20	780W/20Ω	1	400*40*100	119%,10%ED	11Ω
	15	47/56	-	-	JNBR-2R4KW13R6	2400W/13.6Ω	1	535*50*110 (*2 pcs)	117%, 10%ED	11Ω
	20	60/69	-	-	JNBR-3KW10	3000W/10Ω	1	615*50*110 (*2 pcs)	119%, 10%ED	7Ω
	25	73/79	-	-	JNBR-4R8KW8	4800W/8Ω	1	535*50*110 (*4 pcs)	119%, 10%ED	7Ω
	30	85/110	JNTBU-230	1	JNBR-4R8KW6R8	4800W/6.8Ω	1	535*50*110 (*4 pcs)	117%, 10%ED	5.5Ω
	40	115/138	JNTBU-230	2	JNBR-3KW10	3000W/10Ω	2	615*50*110 (*4 pcs)	119%, 10%ED	5.5Ω
	50	145/169	JNTBU-230	2	JNBR-3KW10	3000W/10Ω	2	615*50*110 (*4 pcs)	99%, 10%ED	5.5Ω
	60	180/200	JNTBU-230	2	JNBR-4R8KW6R8	4800W/6.8Ω	2	535*50*110 (*8 pcs)	117%, 10%ED	5.5Ω
	75	215/250	JNTBU-230	2	JNBR-4R8KW6R8	4800W/6.8Ω	2	535*50*110 (*12 pcs)	98%, 10%ED	5.5Ω
	100	283/312	JNTBU-230	3	JNBR-4R8KW6R8	4800W/6.8Ω	3	535*50*110 (*12 pcs)	108%, 10%ED	5.5Ω
	125	346/400	JNTBU-230	4	JNBR-4R8KW6R8	4800W/6.8Ω	4	535*50*110 (*16 pcs)	110%,10%ED	5.5Ω
	150	415/450	JNTBU-230	4	JNBR-4R8KW6R8	4800W/6.8Ω	4	535*50*110 (*16 pcs)	100%,10%ED	5.5Ω

Inverter			Braking unit		Braking resistor				Braking torque (Peak / Continues)	Minimum Resistance *1
Input Voltage	HP	Rated Current (A) HD/ND	Model	Qty Req.	Part Number	Resistor specification	Qty Req.	Resistor dimensions (L*W*H) mm		
400V 3Ø	1	3.4/4.1	-	-	JNBR-150W750	150W/750Ω	1	251*27*60	126%, 10%ED	120Ω
	2	4.2/5.4	-	-	JNBR-150W400	150W/400Ω	1	251*27*60	119%, 10%ED	120Ω
	3	5.5/6.9	-	-	JNBR-260W250	260W/250Ω	1	274*34*78	126%, 10%ED	100Ω
	5	9.2/11.1	-	-	JNBR-400W150	400W/150Ω	1	395*34*78	126%, 10%ED	60Ω
	7.5	14.8/17.5	-	-	JNBR-600W130	600W/130Ω	1	470*40*100	102%, 10%ED	43Ω
	10	18/23	-	-	JNBR-800W100	800W/100Ω	1	535*50*110	99%, 10%ED	43Ω
	15	24/31	-	-	JNBR-1R6KW50	1600W/50Ω	1	615*50*110	126%, 10%ED	43Ω
	20	31/38	-	-	JNBR-1R5KW40	1500W/40Ω	1	615*50*110	119%, 10%ED	22Ω
	25	39/44	-	-	JNBR-4R8KW32	4800W/32Ω	1	535*50*110 (*4 pcs)	119%, 10%ED	14Ω
	30	45/58	-	-	JNBR-4R8KW27R2	4800W/27.2Ω	1	535*50*110 (*4 pcs)	117%, 10%ED	14Ω
	40	60/72	JNTBU-430	1	JNBR-6KW20	6000W/20Ω	1	615*50*110 (*4 pcs)	119%, 10%ED	19.2Ω
	50	75/88	JNTBU-430	2	JNBR-4R8KW32	4800W/32Ω	2	535*50*110 (*8 pcs)	119%, 10%ED	19.2Ω
	60	91/103	JNTBU-430	2	JNBR-4R8KW27R2	4800W/27.2Ω	2	535*50*110 (*8 pcs)	117%, 10%ED	19.2Ω
	75	118/145	JNTBU-430	2	JNBR-6KW20	6000W/20Ω	2	615*50*110 (*8 pcs)	126%, 10%ED	19.2Ω
	100	150/165	JNTBU-430	3	JNBR-6KW20	6000W/20Ω	3	615*50*110 (*12 pcs)	139%, 10%ED	19.2Ω
	125	180/208	JNTBU-430	3	JNBR-6KW20	6000W/20Ω	3	615*50*110 (*12 pcs)	115%, 10%ED	19.2Ω
	150	216/250	JNTBU-430	4	JNBR-6KW20	6000W/20Ω	4	615*50*110 (*12 pcs)	125%, 10%ED	19.2Ω
	175	260/296	JNTBU-430	4	JNBR-6KW20	6000W/20Ω	4	615*50*110 (*20 pcs)	111%, 10%ED	19.2Ω
	215	295/328	JNTBU-430	5	JNBR-6KW20	6000W/20Ω	5	615*50*110 (*24 pcs)	112%, 10%ED	19.2Ω
	250	370/435	JNTBU-430	5	JNBR-6KW20	6000W/20Ω	5	615*50*110 (*24 pcs)	99%,10%ED	19.2Ω
300	450/515	JNTBU-430	6	JNBR-6KW20	6000W/20Ω	6	615*50*110 (*32 pcs)	99%,10%ED	19.2Ω	
375	523/585	JNTBU-430	8	JNBR-6KW20	6000W/20Ω	8	615*50*110 (*40 pcs)	105%,10%ED	19.2Ω	

Inverter			Braking unit		Braking resistor				Braking torque (Peak / Continues)	Minimum Resistance ^{*1}
Input Voltage	HP	Rated Current (A) HD/ND	Model	Qty Req.	Part Number	Resistor specification	Qty Req.	Resistor dimensions (L*W*H) mm		
	425	585/585	JNTBU-430	9	JNBR-6KW20	6000W/20Ω	9	615*50*110 (*40 pcs)	104%,10%ED	19.2Ω

*1: Minimum resistance is the acceptable minimum value of the braking resistor for a single braking unit.

Note: Keep sufficient space between inverter, braking unit and braking resistor and ensure proper cooling is provided for.

Information
provided by
EMAG
Tel: 01902 601403
www.emag-ltd.co.uk

11.2 AC Line Reactors

An AC line reactor can be used for any of the following:

- Capacity of power system is much larger than the inverter rating.
- Inverter mounted close to the power system (in 33ft / 10 meters).
- Reduce harmonic contribution (improve power factor) back to the power line.
- Protect inverter input diode front-end by reducing short-circuit current.
- Minimize overvoltage trips due to voltage transients.

Please select the AC line reactor based on the inverter rating according to the following table.

Table 11.2.1 List of AC Line Reactors



Model		AC reactor	
Input Voltage	HP	Model	Specification (mH/A)
3 ϕ 220V	1	JNACL2P1M5A2	2.1mH/5A
	2	JNACL1P1M10A2	1.1mH/10A
	3	JNACL0P71M15A2	0.71mH/15A
	5	JNACL0P53M20A2	0.53mH/20A
	7.5	JNACL0P35M30A2	0.35mH/30A
	10	JNACL0P265M40A2	0.265mH/40A
	15	JNACL0P18M60A2	0.18mH/60A
	20	JNACL0P13M80A2	0.13mH/80A
	25	JNACL0P12M90A2	0.12mH/90A
	30	JNACL0P09M120A2	0.09mH/120A
	40	JNACL0P07M160A2	0.07mH/160A
	50	JNACL0P05M200A2	0.05mH/200A
	60	JNACL0P044M240A2	0.044mH/240A
	75	JNACL0P038M280A2	0.038mH/280A
	100	JNACL0P026M360A2	0.026mH/360A
125	JNACL0P02M500A2	0.02mH/500A	
150	JNACL0P02M560A2	0.02mH/560A	



Table 11.2.1 List of AC Line Reactors (continued)

Model		AC reactor	
Input Voltage	HP	Model	Specification (mH/A)
3 ϕ 440V	1	JNACL8P4M3A4	8.4mH/3A
	2	JNACL4P2M5A4	4.2mH/5A
	3	JNACL3P6M7P5A4	3.6mH/7.5A
	5	JNACL2P2M10A4	2.2mH/10A
	7.5	JNACL1P42M15A4	1.42mH/15A
	10	JNACL1P06M20A4	1.06mH/20A
	15	JNACL0P7M30A4	0.7mH/30A
	20	JNACL0P53M40A4	0.53mH/40A
	25	JNACL0P42M50A4	0.42mH/50A
	30	JNACL0P36M60A4	0.36mH/60A
	40	JNACL0P26M80A4	0.26mH/80A
	50	JNACL0P24M90A4	0.24mH/90A
	60	JNACL0P18M120A4	0.18mH/120A
	75	JNACL0P15M150A4	0.15mH/150A
	100	JNACL0P11M200A4	0.11mH/200A
	125	JNACL0P09M250A4	0.09mH/250A
	150/175	JNACL0P06M330A4	0.06mH/330A
	215/250	JNACL0P05M400A4	0.05mH/400A
300	JNACL0P04M500A4	0.04mH/500A	
375/425	JNACL0P032M670A4	0.032mH/670A	

Note: AC reactors listed in this table can only be used for the inverter input side. Do not connect AC reactor to the inverter output side. Both 200V class 50HP ~ 150HP and 400V class 75HP ~ 425HP have a built-in DC reactors. If required by the application an AC reactor may be added.

11.3 Harmonic Filters

Model	Rated load power @400VAC /50Hz [kW]	Rated load power @500VAC /50Hz [kW]	Filter efficiency @25°C /50Hz [%]	Input/output connections 	Capacitance disconnections 	Weight [Kg]	NEMA 1 cover** Part Number
FN 341x-10-44	4	5.5	98.5	-44	-44	13	1151-081
FN 341x-13-44	5.5	7.5	98.5	-44	-44	14	1151-081
FN 341x-16-44	7.5	11	98.5	-44	-44	21	1151-082
FN 341x-24-33	11	15	98.5	-33	-44	27	1151-083
FN 341x-32-33	15	18.5	98.5	-33	-44	31	1151-083
FN 341x-38-33	18.5	22	98.6	-33	-44	35	1151-083
FN 341x-45-34	22	30	98.7	-34	-33	45	1151-084
FN 341x-60-34	30	37	98.8	-34	-33	54	1151-084
FN 341x-75-35	37	45	98.9	-35	-34	65	1151-085
FN 341x-90-35	45	55	99	-35	-34	77	1151-085
FN 341x-110-35	55	75	99.1	-35	-34	86	1151-085
FN 341x-150-40	75	90	99.2	-40	-35	118	1151-086
FN 341x-180-40	90	110	99.3	-40	-35	136	1151-086
FN 341x-210-40	110	132	99.3	-40	-35	154	1151-086
FN 341x-260-99	132	160	99.4	-99	-35	201	1151-086
FN 341x-320-99	160	200	99.5	-99	-35	201	1151-086

Model	Rated load power @460VAC /60Hz [kW]	Filter efficiency @25°C /50Hz [%]	Input / output connections 	Capacitance disconnections 	Weight [Kg]	NEMA 1 cover** Part Number
FN 341x-8-44	5	98.5	-44	-44	12	1151-081
FN 341x-11-44	7.5	98.5	-44	-44	13	1151-081
FN 341x-15-44	10	98.5	-44	-44	17	1151-082
FN 341x-21-33	15	98.5	-44	-44	21	1151-082
FN 341x-28-33	20	98.6	-33	-44	28	1151-083
FN 341x-35-33	25	98.6	-33	-44	32	1151-083
FN 341x-41-34	30	98.7	-33	-44	35	1151-083
FN 341x-53-34	40	98.9	-34	-33	48	1151-084
FN 341x-65-35	50	99	-34	-33	52	1151-084
FN 341x-80-35	60	99.1	-35	-34	69	1151-085
FN 341x-105-35	75	99.2	-35	-34	77	1151-085
FN 341x-130-35	100	99.3	-35	-34	87	1151-085
FN 341x-160-40	125	99.4	-40	-35	124	1151-086
FN 341x-190-40	150	99.4	-40	-35	132	1151-086
FN 341x-240-99	200	99.5	-99	-35	185	1151-086
FN 341x-310-99	250	99.5	-99	-35	202	1151-086

Part Number	Dimensions (mm)											
	A	B	C	E	F	G	J	V	W	X	Y	Z
FN 3410/FN 3411-10	400	170	190	380	130	7	M6	--	--	--	--	--
FN 3410/FN 3411-13	700	170	190	380	130	7	M6	--	--	--	--	--
FN 3410/FN 3411-16	430	210	210	410	170	9	M6	--	--	--	--	--
FN 3410/FN 3411-24	520	250	280	495	200	11	M8	--	--	--	--	--
FN 3410/FN 3411-32	520	250	280	495	200	11	M8	--	--	--	--	--
FN 3410/FN 3411-38	520	250	280	495	200	11	M8	--	--	--	--	--
FN 3410/FN 3411-45	590	300	300	565	250	11	M8	--	--	--	--	--
FN 3410/FN 3411-60	590	300	300	565	250	11	M8	--	--	--	--	--
FN 3410/FN 3411-75	750	320	300	725	270	11	M10	--	--	--	--	--
FN 3410/FN 3411-90	750	320	300	725	270	11	M10	--	--	--	--	--
FN 3410/FN 3411-110	750	320	300	725	270	11	M10	--	--	--	--	--
FN 3410/FN 3411-150	1000	500	450	240	338	14X30	M10	--	--	--	--	--
FN 3410/FN 3411-180	1000	500	450	240	338	14X30	M10	--	--	--	--	--
FN 3410/FN 3411-210	1000	500	450	240	338	14X30	M10	--	--	--	--	--
FN 3410/FN 3411-260	1000	500	450	240	338	14X30	M10	25	6	12.5	40	11
FN 3410/FN 3411-320	1000	500	450	240	338	14X30	M10	25	6	12.5	40	11
FN 3412/FN 3413-08	400	170	190	380	130	7	M6	--	--	--	--	--
FN 3412/FN 3413-11	700	170	190	380	130	7	M6	--	--	--	--	--
FN 3412/FN 3413-15	430	210	210	410	170	9	M6	--	--	--	--	--
FN 3412/FN 3413-21	430	210	210	410	170	9	M6	--	--	--	--	--
FN 3412/FN 3413-28	520	250	280	495	200	11	M8	--	--	--	--	--
FN 3412/FN 3413-35	520	250	280	495	200	11	M8	--	--	--	--	--
FN 3412/FN 3413-41	520	250	280	495	200	11	M8	--	--	--	--	--
FN 3412/FN 3413-53	590	300	300	565	250	11	M8	--	--	--	--	--
FN 3412/FN 3413-65	590	300	300	565	250	11	M8	--	--	--	--	--
FN 3412/FN 3413-80	750	320	300	725	270	11	M10	--	--	--	--	--
FN 3412/FN 3413-105	750	320	300	725	270	11	M10	--	--	--	--	--
FN 3412/FN 3413-130	750	320	300	725	270	11	M10	--	--	--	--	--
FN 3412/FN 3413-160	1000	500	450	240	338	14X30	M10	--	--	--	--	--
FN 3412/FN 3413-190	1000	500	450	240	338	14X30	M10	--	--	--	--	--
FN 3412/FN 3413-240	1000	500	450	240	338	14X30	M10	25	6	12.5	40	11
FN 3412/FN 3413-310	1000	500	450	240	338	14X30	M10	25	6	12.5	40	11

Mechanical data

FN 3410/FN 3411-10 to -110
FN 3412/FN 3413-8 to -130

FN 3410/FN 3411-150 to -210
FN 3412/FN 3413-160 to -190

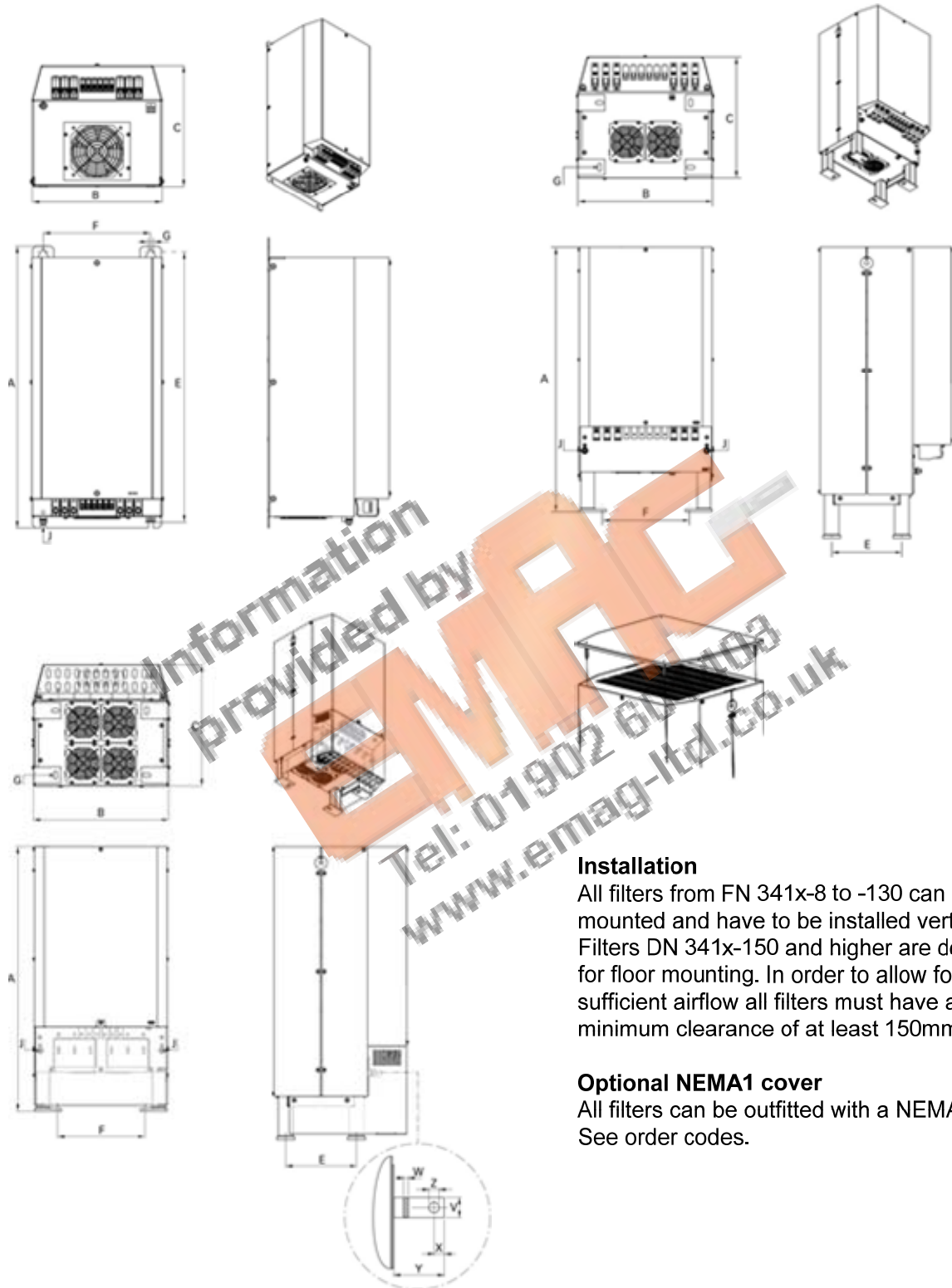





Information provided by **EMAG**
Tel: 01902 604103
www.emag-ltd.co.uk

Installation

All filters from FN 341x-8 to -130 can be wall mounted and have to be installed vertically. Filters DN 341x-150 and higher are designed for floor mounting. In order to allow for sufficient airflow all filters must have a minimum clearance of at least 150mm (6").

Optional NEMA1 cover

All filters can be outfitted with a NEMA1 cover. See order codes.

Filter connector cross sections	-33	-34	-34	-40	-44
					
Solid wire	16mm ²	35mm ²	50mm ²	95mm ²	10mm ²
Flexible wire	10mm ²	25mm ²	50mm ²	95mm ²	6mm ²
AWG type wire	AWG 6	AWG 2	AWG 1/0	AWG 4/0	AWG 8
Recommended torque	1.5-1.8Nm	4.0-4.5Nm	7.0-8.0Nm	17-20Nm	1.0-1.2Nm

Information
provided by
EMAG
Tel: 01902 601403
www.emag-ltd.co.uk

11.4 Input Noise Filters

A. Input Noise Filter on Specifications & Ratings

Install a noise filter on power supply side to eliminate noise transmitted between the power line and the inverter. The inverter noise filter shown in Table 11.4.1 below meets the EN61800-3 class A specification. 400V inverter class models can be ordered with integrated noise filter.

Table 11.4.1 Input Noise Filter Specifications and Ratings

Inverter size		Noise filter			
Input voltage	HP	Model	Rated current	Dimension	Part Number
200V 1Ø	1HP/2HP	FS32121-18-99	18	350*100*55	1HP/2HP
	3HP	FS32120-23-99	23	350*100*55	3HP
200V 3Ø	1HP/2HP	FS32125-11-99	11	263.8*45*70	1HP/2HP
	3HP/5HP	FS32124-23-99	23	290*50*85	3HP/5HP
	7.5HP/10HP	FS32123-42-99	42	330*85*90	7.5HP/10HP
	15HP	FS32125-61-99	61	318*80*135	15HP
	20HP/25HP	FS32125-86-99	86	360*95*90	20HP/25HP
	30HP/40HP	FS32125-150-99	150	320*226.5*86	30HP/40HP
	50HP/60HP	FS32125-232-99	232	320*226.5*86	50HP/60HP
	75HP/100HP	FS32125-343-99	343	320*226.5*86	75HP/100HP
	125HP/150HP	FS6100-600-99	600		125HP/150HP
400V 3Ø	1HP/2HP/3HP	JN5-FLT-8A	8	102*130*92	1HP/2HP/3HP
	5HP/7.5HP	JN5-FLT-19A	19	123*141*92	5HP/7.5HP
	10HP/15HP	JN5-FLT-33A	33	132*206*124	10HP/15HP
	20HP/25HP/30HP	JN5-FLT-63A	63	127*260*131	20HP/25HP/30HP
	40HP/50HP/60HP	JN5-FLT-112A	112	186*284*128	40HP/50HP/60HP
	75HP/100HP	FS32126-181-99	181	320*226.5*86	75HP/100HP
	125HP/150HP/175HP/215HP	FS32126-361-99	361	320*226.5*86	125HP/150HP/175HP/215HP
	250HP/300HP/375HP/425HP	FS6101-800-99	800		250HP/300HP/375HP/425HP

B. Input or Output Noise Filter (EMI Suppression Zero Phase Core)

- Part Number: 4H000D0250001
- Select a matched ferrite core to suppress EMI noise according to the required power rating and wire size.
- The ferrite core can attenuate high frequencies in the range of 100 kHz to 50 MHz, as shown in figure 11.4.1 below, and therefore should minimize the RFI generated by the inverter.
- The zero-sequence noise ferrite core can be installed either on the input side or on the output side. The wire around the core for each phase should be wound by following the same convention and in one direction. The more turns without resulting in saturation the better the attenuation. If the wire size is too large to be wound, all the wiring can be grouped and put through several cores together in one direction.

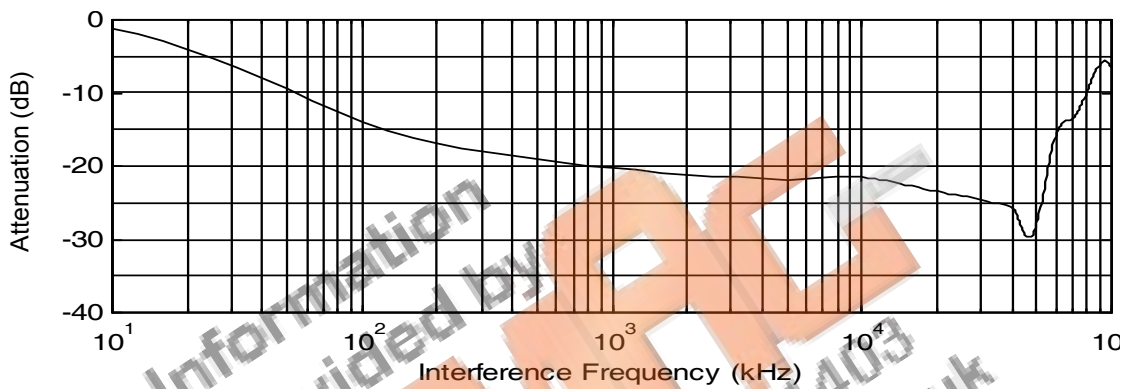

Fig. 11.4.1 Frequency attenuation characteristics (10 windings case)

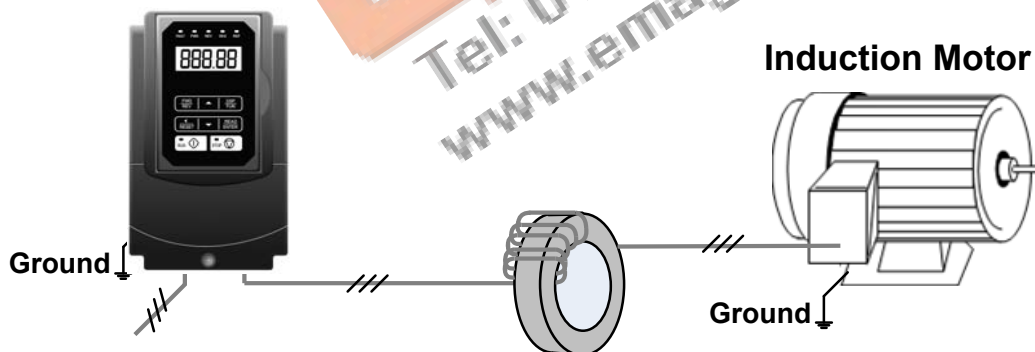



Fig. 11.4.2 Example of EMI Suppression Zero Phase Core Application

Note: All the wiring of phases U/T1, V/T2, W/T3 must pass through the same zero-phase core without crossing over.

11.5 Output Filters

Model	Rated current @45°C/ 50Hz [A]	Rated current @45°C/ 100Hz [A]	Typical motor power [kW]	Nominal Ind.[mH]	Nominal Cap.[μF]	Cap. connection	Min. Switching freq. [kHz]	Typical power loss [W]	Input/Output connections		Weight [Kg]
											
FN 5040-4.5-82	4.5	4.05	1.1/1.5	13	2.2	Y	4	65	-82		3.3
FN 5040-8-82	8	7.2	2.2/3	6.9	4.7	Y	4	80	-82		4.6
FN 5040-10-83	10	9	4	5.2	6.8	Y	4	90	-83		6.1
FN 5040-17-83	17	15.3	5.5/75.5	3.1	10	Y	4	115	-83		7.58
FN 5040-24-84	24	21.6	11	2.4	10	Y	4	150	-84		14.4
FN 5040-38-84	38	34.2	15/18.5	1.6	10	Y	4	170	-84		25
FN 5040-48-85	48	43.2	22	1.1	14.7	Y	4	260	-85		33
FN 5040-62-85	62	55.8	30	0.85	30	Y	3	280	-85		36
FN 5040-75-87	75	67.5	37	0.75	30	Y	3	330	-87		42
FN 5040-115-87	115	103.5	45/55	0.5	20	Δ	3	500	-87		68
FN 5040-180-99	180	162	75/90	0.3	33	Δ	3	680	-99		86
FN 5040-260-99	260	234	110/132	0.2	47	Δ	3	880	-99		125
FN 5040-410-99	410	369	160/200	0.13	66	Δ	3	1100	-99		184
FN 5040-480-99	480	432	250	0.11	94	Δ	3	1350	-99		235
FN 5040-660-99	660	594	315/355	0.14	141	Δ	2	2000	-99		310
FN 5040-750-99	750	675	400	0.12	165	Δ	2	2800	-99		470
FN 5040-880-99	880	792	450/500	0.11	188	Δ	2	3400	-99		640

FN 5040-1200-99	1200	1080	560/630	0.075	282	Δ	2	3800		-99	680
FN 5045-4.5-44	4.5	4.05	1.1/1.5	13	2.2	Y	4	65	-44		4.1
FN 5045-8-44	8	7.2	2.2/3	6.9	4.7	Y	4	80	-44		5.4
FN 5045-10-44	10	9	4	5.2	6.8	Y	4	90	-44		6.9
FN 5045-17-33	17	15.3	5.5/7.5	3.1	10	Y	4	115	-33		9
FN 5045-24-33	24	21.6	11	2.4	10	Y	4	150	-33		15.6
FN 5045-38-33	38	34.2	15/18.5	1.6	10	Y	4	170	-33		18.9
FN 5045-48-34	48	43.2	22	1.1	14.7	Y	4	260	-34		35.8
FN 5045-62-34	62	55.8	30	0.85	30	Y	3	280	-34		37.8
FN 5045-75-35	75	67.5	37	0.75	30	Y	3	330	-35		60
FN 5045-115-35	115	103.5	45/55	0.5	20	Δ	3	500	-35		70
FN 5048-180-99	180	162	75/90	0.3	33	Δ	3	680		-99	92
FN 5045-260-99	260	234	110/132	0.2	47	Δ	3	880		-99	131
FN 5045-410-99	410	369	160/200	0.13	66	Δ	3	1100		-99	198
FN 5045-480-99	480	432	250	0.11	94	Δ	3	1350		-99	243
FN 5045-660-99	660	594	315/355	0.14	141	Δ	2	2000		-99	425
FN 5045-750-99	750	675	400	0.12	162	Δ	2	2800		-99	482
FN 5045-880-99	880	792	450/500	0.11	188	Δ	2	3400		-99	652
FN 5045-1200-99	1200	1080	560/630	0.075	282	Δ	2	3800		-99	692

11.6 Input Current and Fuse Specifications

200V class

Model	Horse power	KVA	100% of rated output current HD/ND	3 phases Rated input current HD/ND	Three-phase fuse rating	Single-phase rated input current HD/ND
A510-2001-H	1	1.9	5/6	5.4/6.5	12	9.4/11.3
A510-2002-H	2	3	8/9.6	8.5/10.3	15	14.7/17.9
A510-2003-H	3	4.2	11/12	11.7/12.8	20	20.3/22.1
A510-2005-H3	5	6.7	17.5/21	18.7/22.3	30	X
A510-2008-H3	7.5	9.5	25/30	26.3/31.6	50	X
A510-2010-H3	10	12.6	33/40	34.5/41.7	60	X
A510-2015-H3	15	17.9	47/56	51.1/60.9	100	X
A510-2020-H3	20	22.9	60/69	65.2/75	125	X
A510-2025-H3	25	28.6	73/79	79.4/85.9	125	X
A510-2030-H3	30	32.4	85/110	92.4/119.6	150	X
A510-2040-H3	40	43.8	115/138	125/150	200	X
A510-2050-H3	50	55.3	145/169	159/186	250	X
A510-2060-H3	60	68.6	180/200	186/232	300	X
A510-2075-H3	75	81.9	215/250	232/275	350	X
A510-2100-H3	100	108	283/312	275/343	450	X
A510-2125-H3	125	132	346/400	380/440	600	X
A510-2150-H3	150	158	415/450	456/495	800	X

400V class

Model	Horse power	KVA	100% of rated output current HD/ND	Rated input current HD/ND	Fuse rating
A510-4001-H3(F)	1	2.6	3.4/4.1	3.7/4.5	6
A510-4002-H3(F)	2	3.2	4.2/5.4	5.3/5.9	10
A510-4003-H3(F)	3	4.2	5.5/6.9	6.0/7.5	10
A510-4005-H3(F)	5	7	9.2/11.1	9.6/11.6	20
A510-4008-H3(F)	7.5	11.3	14.8/17.5	15.5/18.2	25
A510-4010-H3(F)	10	13.7	18/23	18.7/24.0	30
A510-4015-H3(F)	15	18.3	24/31	25.0/32.3	50
A510-4020-H3(F)	20	23.6	31/38	33.7/41.3	60
A510-4025-H3(F)	25	29.7	39/44	42.4/47.8	70
A510-4030-H3(F)	30	34.3	45/58	48.9/58.7	80
A510-4040-H3(F)	40	45.7	60/72	65.2/78.3	100
A510-4050-H3(F)	50	57.2	75/88	81.5/95.7	125
A510-4060-H3(F)	60	69.3	91/103	98.9/112	150
A510-4075-H3	75	85.4	118/145	130/159	200
A510-4100-H3	100	114	150/165	159/181	250
A510-4125-H3	125	137	180/208	181/229	300
A510-4150-H3	150	165	216/250	229/275	350
A510-4175-H3	175	198	260/296	275/325	400
A510-4215-H3	215	225	295/328	325/361	450
A510-4250-H3	250	270	370/435	407/478	600
A510-4300-H3	300	317	450/515	495/566	800
A510-4375-H3	375	400	523/585	575/643	1000
A510-4425-H3	425	400	585/585	643.5/643.5	1000

Fuse type: Choose semiconductor fuse to comply with UL.

Class: CC, J, T, RK1 or RK5

Voltage Range:

For 200V class inverter, use 300V class fuse.

For 400V class inverter, use 600V class fuse.

11.7 PG Speed Feedback Card

Refer to the dedicated option card manual for installation instructions.

A) JN5-PG-O speed feedback card: Open collector speed feedback card

JN5-PG-O terminal specification:

Terminal Name	Description
Vcc	Power supply for encoder. 12V or 5V $\pm 5\%$, 200mA Maximum
GND (0V Common Terminal)	(12V or 5V input voltage selected by the Switch Jumper. Can't use both 12V and 5V at the same time)
A, A\, B, B\, Z, Z\	Encoder input signal, two-phase input is required for correct divider ratio output. Open collector input type.
AO, AO\, BO, BO\, ZO, ZO\	A ,B phase divider ratio output, z phase output monitor, Open collector type: 24V, 200mA.
E	Grounding Terminal.

JN5-PG-O block diagram:

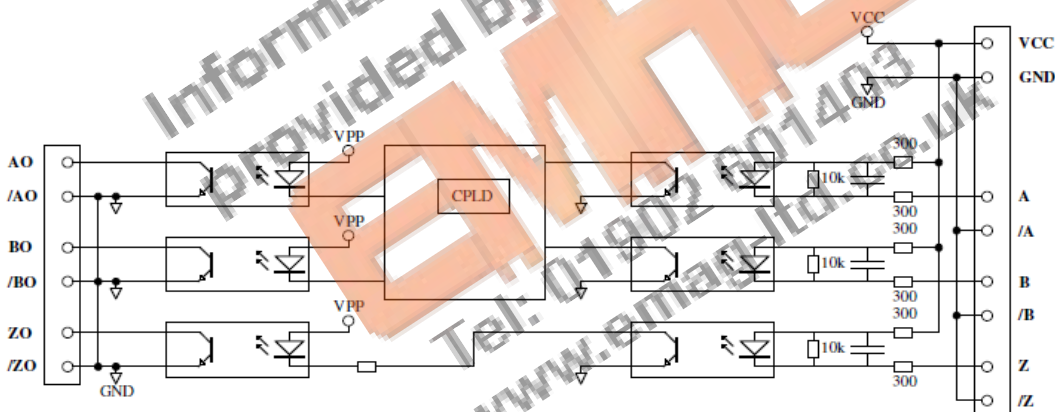

B) JN5-PG-L speed feedback card: Line driver speed feedback card

JN5-PG-L terminal specification

Terminal Name	Description
Vcc	Power supply for encoder. 12V or 5V $\pm 5\%$, 200mA Maximum
GND (0V Common Terminal)	(12V or 5V input voltage selected by the Switch Jumper. Can't use both 12V and 5V at the same time)
A, A\, B, B\, Z, Z\	Encoder input signal, A correct divider ratio output requires a two-phase input. Line driver input type, RS-422 level input.
AO, AO\, BO, BO\, ZO, ZO\	A ,B phase divider ratio output, z phase output monitor, Line driver output type, RS-422 level output.
E	Grounding terminal.

JN5-PG-L block diagram:

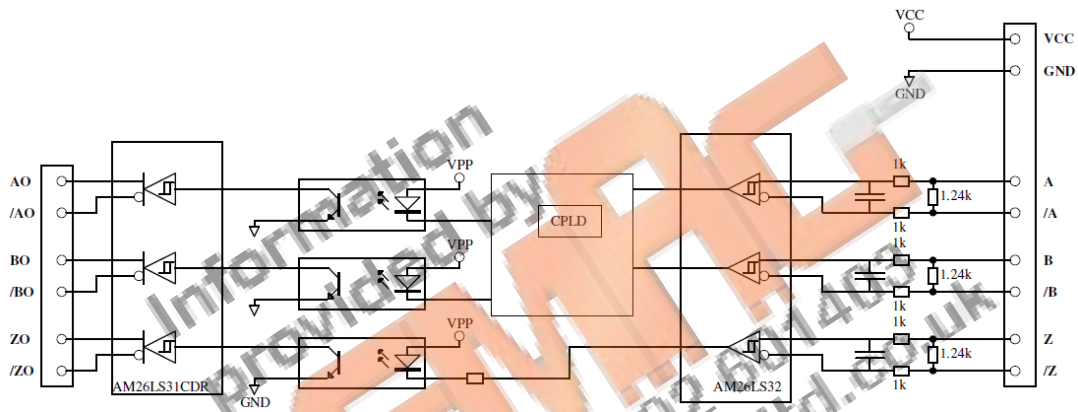

C) JN5-PG-PM speed feedback card: synchronous motor line driver speed feedback card

JN5-PG-PM terminal specification

Terminal Name	Description
Vcc	Power supply for encoder.
GND (0V Common Terminal)	5V \pm 5%, 200mA Maximum
A, A\, B, B\, Z, Z\ U, U\, V, V\, Z, Z\ AO, AO\ BO, BO\ ZO, ZO\ E	Encoder input signal, A correct divider ratio output requires a two-phase input. Line driver input type, RS-422 level input. A ,B phase divider ratio output, z phase output monitor, Line driver output type, RS-422 level output. Grounding terminal.

JN5-PG-PM block diagram:

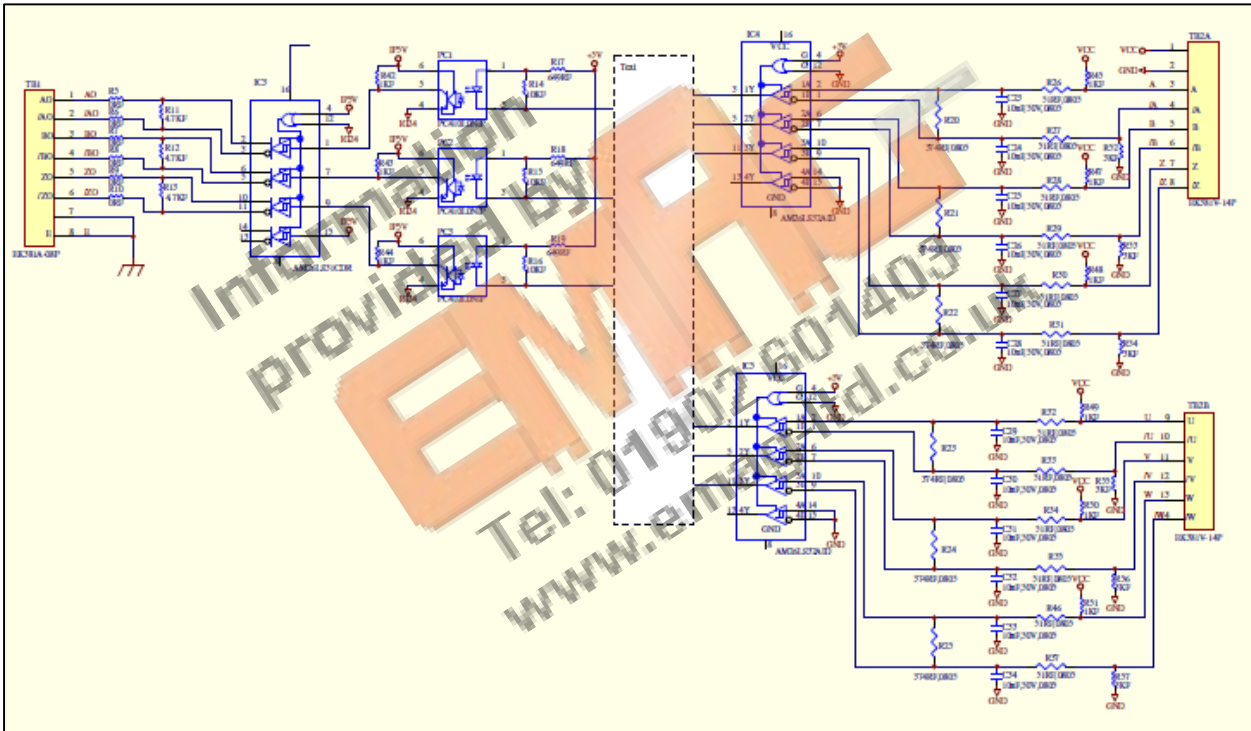

D) JN5-PG-PMS speed feedback card with HEIDENHAIN ERN1387 encoder

JN5-PG-PMS terminal specification

Terminal Name	Description
E5V	Power supply for encoder.
GND (0V Common Terminal)	5V \pm 5%, 200mA Maximum
C+, C-, D+, D-, -	Sinusoidal signals from encoder. 0.6 to 1.2Vpp.
A+, A-, B+, B-	Sinusoidal incremental signals from encoder. 0.6 to 1.2Vpp. Max. Input frequency: 20 kHz.
R+, R-	Reference mark signal from encoder. 0.2 to 2.35Vpp
a+, a-, b+, b-	Monitor signal output, line driver Output Type, RS-422 level.
E	Grounding terminal

E) JN5-PG-PMR speed feedback card with TAMAGAWA Resolver Encoder

JN5-PG-PMR terminal specification

Terminal Name	Description
R+, R-	Excitation signal to Resolver. 7Vrms, 10KHz.
S1, S3	COS signals from Resolver.
S2, S4	SIN signals from Resolver.
a+, a-, b+, b-, z+, z-	A,B,Z pulse Monitor signal output, Line driver output Type, RS-422 level.
E	Grounding terminal

11.8 Other Options

A. Blank cover and keypad extension cable

When used for remote control purposes, the keypad can be removed and remotely connected with an extension cable. Extension cables are available in the following lengths: 1m (3.3ft), 2m (6.6ft), 3m (10ft), and 5m (16.4ft).

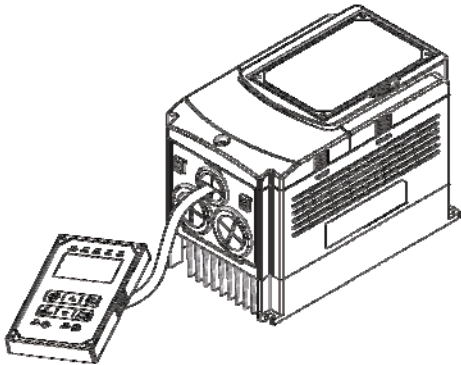

Name	Model	Specification
LED digital operator wire	JN5-CB-01M	1m (3.3ft)
	JN5-CB-02M	2m (6.6ft)
	JN5-CB-03M	3m (10ft)
	JN5-CB-05M	5m (16.4ft)

When using a remote mount keypad a blank cover can be installed in place of the original keypad to prevent dust and debris from entering the inverter.

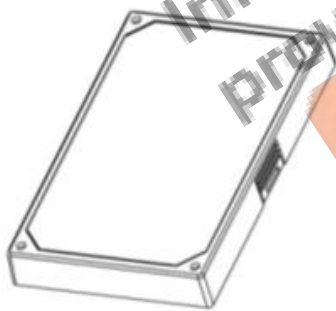

Name	Model	Specification
Blank cover	JN5-OP-A03	Blank cover

Blank keypad cover

LED keypad dimensions

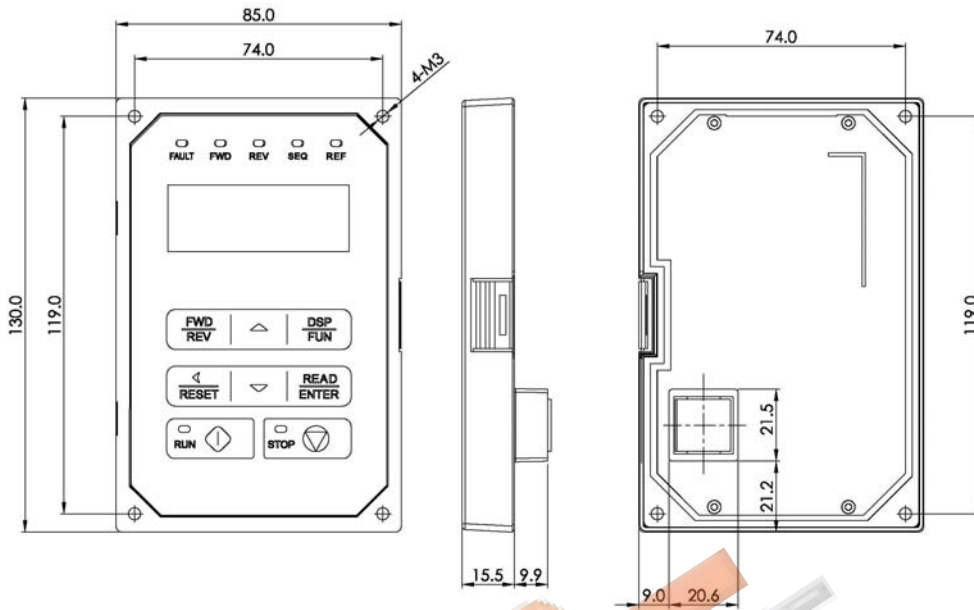

B. Copy Unit (JN5-CU)

The copy unit is used to copy an inverter parameter setup to another inverter. The copy unit saves time in applications with multiple inverters requiring the same parameter setup.

Copy Unit (JN5-CU) dimensions

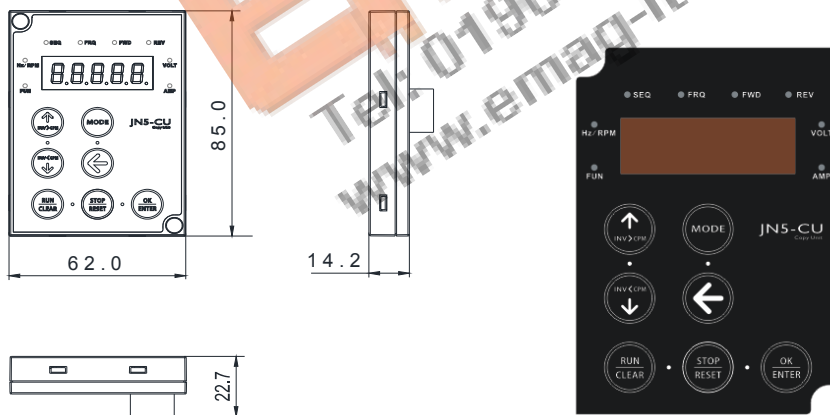

11.9 Communication Options

(a) PROFIBUS communication interface module (JN5-CM-PDP)

For wiring example and communication setup refer to JN5-CM-PDP communication option manual.

(b) DEVICENET communication interface module (JN5-CM-DNET)

For wiring example and communication setup refer to JN5-CM-DNET communication option manual.

(c) CANopen communication interface module (JN5-CM-CAN)

For wiring example and communication setup refer to JN5-CM-VAN communication option manual.

(d) TCP-IP communication interface module (JN5-CM-TCPIP)

For wiring example and communication setup refer to JN5-CM-TCPIP communication option manual.

11.10 Protective Cover

If inverter is around the environment of dust or metal shavings, it is recommended to purchase the protective covers positioned on both sides of the inverter to prevent unknown objects from invading.

Frame	Model
1	JN5-CR-A01
2	JN5-CR-A02
4	JN5-CR-A04

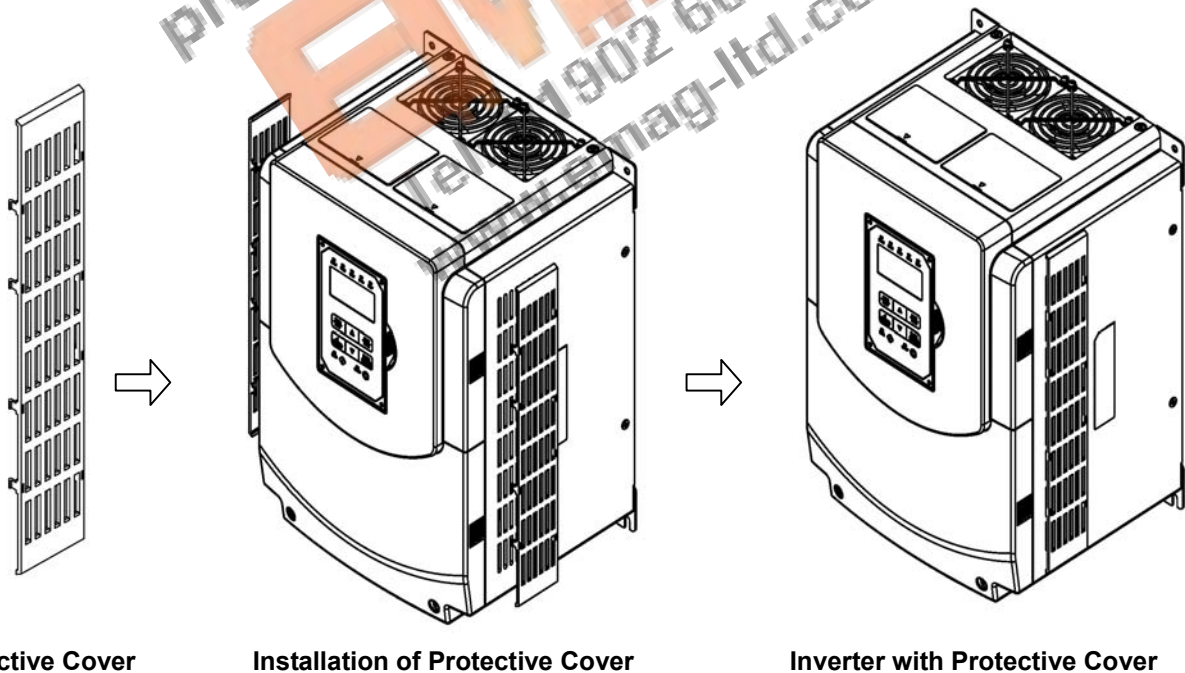

Appendix A: Communication Networks

A1.1 RS485 –Network (Modbus)

This section shows a RS485 network consisting of several inverters communicating using the built-in Modbus RTU protocol.

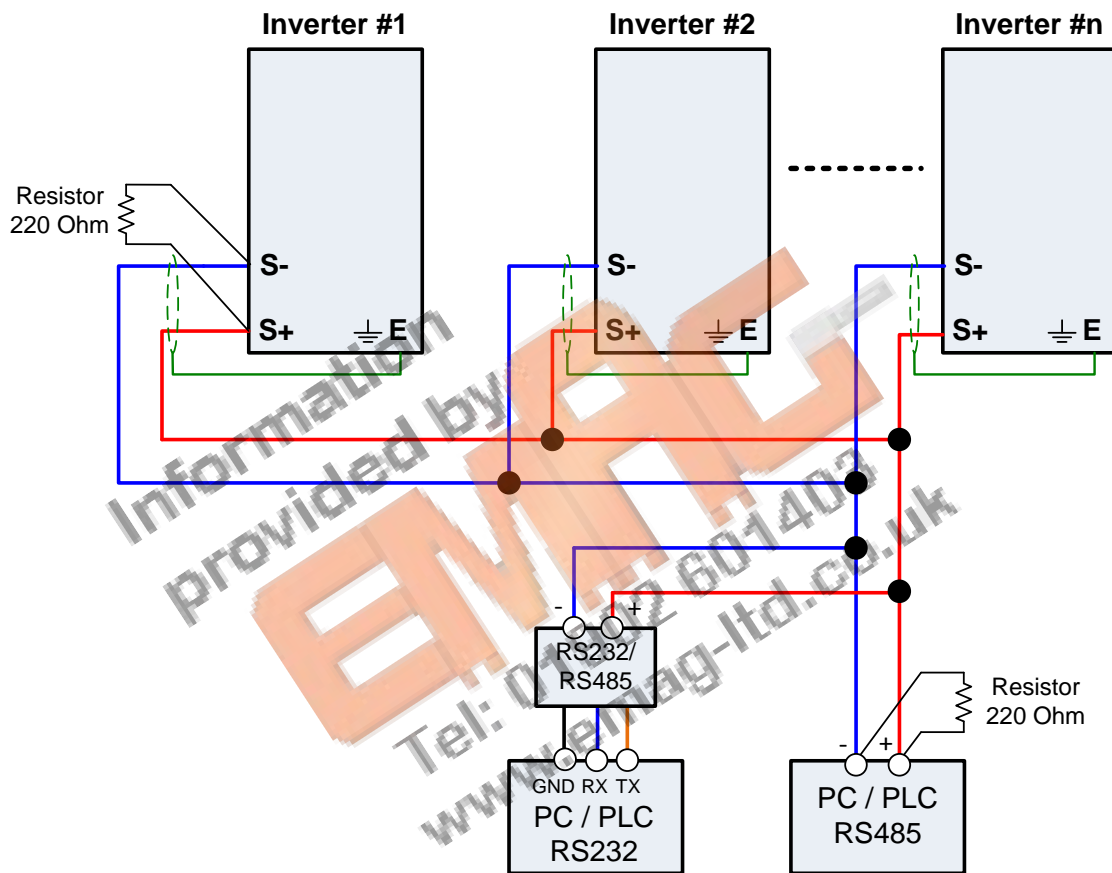

Wiring diagram RS485 Modbus RTU Network

Notes:

- A PC / PLC controller with a built-in RS-485 interface can be connected directly to the RS-485 network. Use a RS232 to RS485 converter to connect a PC / PLC with a built-in RS-232 interface.
- A maximum of 31 inverters can be connected to the network. Terminating resistors of 220 ohm must be installed at both end of the network.

Refer to A510 RS-485 Modbus communication manual for more information.

A1.2 Profibus DP Network

This section shows a Profibus DP network consisting of several inverters communicating using the profibus DB option card.

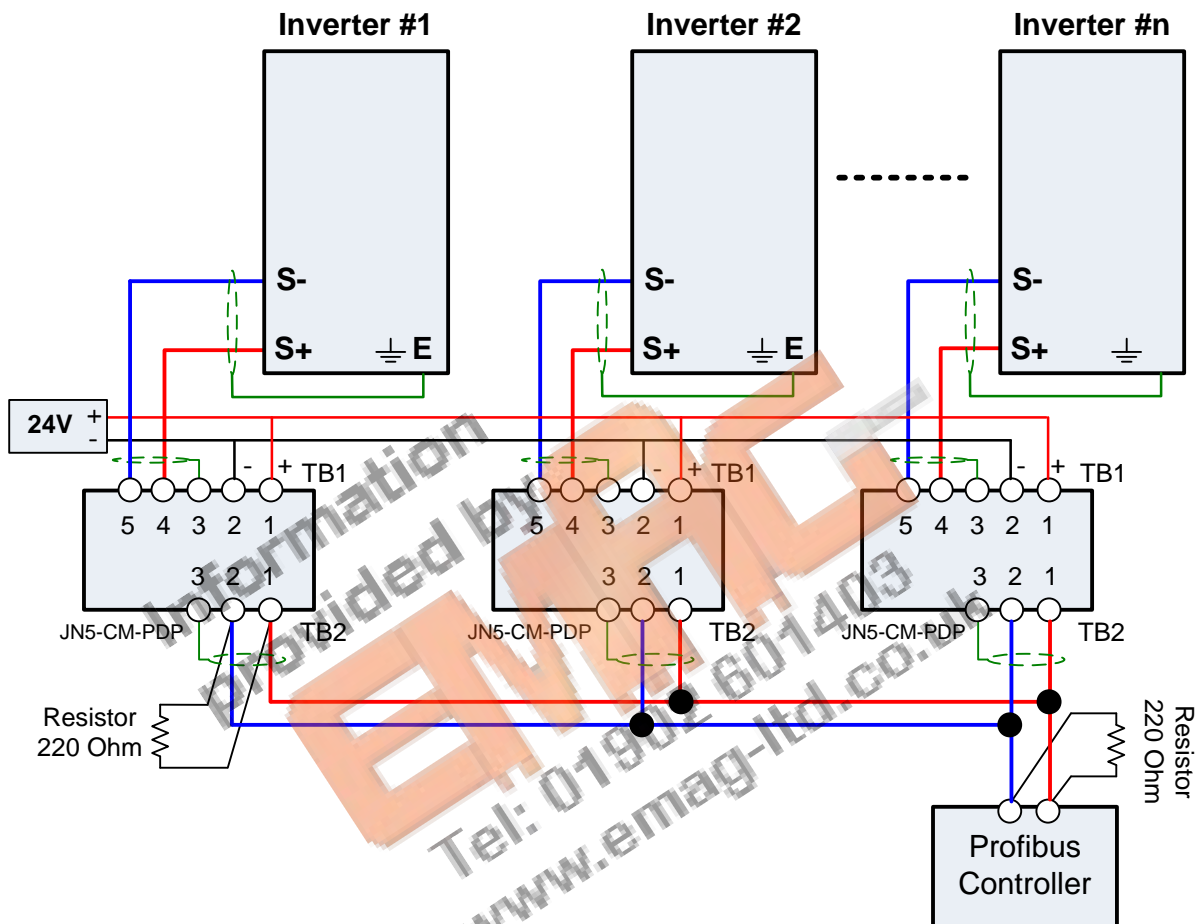

Wiring diagram Profibus DP Network

Notes:

- Requires a Profibus DP option card (JN5-CM-PDP) for each inverter.
- Requires 24Vdc power supply. Size power supply based on the number of inverters on the network.
- A maximum of 31 inverters can be connected to the network. Terminating resistors of 220 ohm must be installed at both end of the network.

Refer to JN5-CM-PDP option communication manual for more information.

Appendix B: UL Instructions

Danger

Electric Shock Hazard

Do not connect or disconnect wiring while the power is on.
Failure to comply will result in death or serious injury.

Warning

Electric Shock Hazard

Do not operate equipment with covers removed.

Failure to comply could result in death or serious injury.

The diagrams in this section may show inverters without covers or safety shields to show details. Be sure to reinstall covers or shields before operating the inverters and run the inverters according to the instructions described in this manual.

Always ground the motor-side grounding terminal.

Improper equipment grounding could result in death or serious injury by contacting the motor case.

Do not touch any terminals before the capacitors have fully discharged.

Failure to comply could result in death or serious injury.

Before wiring terminals, disconnect all power to the equipment. The internal capacitor remains charged even after the power supply is turned off. After shutting off the power, wait for at least the amount of time specified on the inverter before touching any components.

Do not allow unqualified personnel to perform work on the inverter.

Failure to comply could result in death or serious injury.

Installation, maintenance, inspection, and servicing must be performed only by authorized personnel familiar with installation, adjustment, and maintenance of inverters.

Do not perform work on the inverter while wearing loose clothing, jewelry, or lack of eye protection.

Failure to comply could result in death or serious injury.

Remove all metal objects such as watches and rings, secure loose clothing, and wear eye protection before beginning work on the inverter.

Do not remove covers or touch circuit boards while the power is on.

Failure to comply could result in death or serious injury.

Warning

Fire Hazard

Tighten all terminal screws to the specified tightening torque.

Loose electrical connections could result in death or serious injury by fire due to overheating of electrical connections.

Do not use an improper voltage source.

Failure to comply could result in death or serious injury by fire.

Verify that the rated voltage of the inverter matches the voltage of the incoming power supply before applying power.

Do not use improper combustible materials.

Failure to comply could result in death or serious injury by fire. Attach the inverter to metal or other noncombustible material.

NOTICE

Observe proper electrostatic discharge procedures (ESD) when handling the inverter and circuit boards.

Failure to comply may result in ESD damage to the inverter circuitry.

Never connect or disconnect the motor from the inverter while the inverter is outputting voltage.

Improper equipment sequencing could result in damage to the inverter.

Do not use unshielded cable for control wiring.

Failure to comply may cause electrical interference resulting in poor system performance. Use shielded twisted-pair wires and ground the shield to the ground terminal of the inverter.

Do not modify the inverter circuitry.

Failure to comply could result in damage to the inverter and will void warranty. Teco is not responsible for any modification of the product made by the user. This product must not be modified.

Check all the wiring to ensure that all connections are correct after installing the inverter and connecting any other devices.

Failure to comply could result in damage to the inverter.

❖ **UL Standards**

The UL/cUL mark applies to products in the United States and Canada and it means that UL has performed product testing and evaluation and determined that their stringent standards for product safety have been met. For a product to receive UL certification, all components inside that product must also receive UL certification.



❖ **UL Standards Compliance**

This inverter is tested in accordance with UL standard UL508C and complies with UL requirements. To ensure continued compliance when using this inverter in combination with other equipment, meet the following conditions:

■ **Installation Area**

Do not install the inverter to an area greater than pollution severity 2 (UL standard).

■ Main Circuit Terminal Wiring

UL approval requires crimp terminals when wiring the inverter's main circuit terminals. Use crimping tools as specified by the crimp terminal manufacturer. Teco recommends crimp terminals made by NICHIFU for the insulation cap.

The table below matches inverter models with crimp terminals and insulation caps. Orders can be placed with a Teco representative or directly with the Teco sales department.

Closed-Loop Crimp Terminal Size

Drive Model A510	Wire Gauge mm ² , (AWG)		Terminal Screws	Crimp Terminal Model No.	Tool Machine No.	Insulation Cap Model No.
	R/L1 · S/L2 · T/L3	U/T1 · V/T2 · W/T3				
2002	2 (14)		M4	R2-4	Nichifu NH 1 / 9	TIC 2
	3.5 (12)			R5.5-4		TIC 3.5
	5.5 (10)					TIC 5.5
2005	5.5 (10)		M4	R5.5-4	Nichifu NH 1 / 9	TIC 5.5
2010	8 (8)		M4	R8-4	Nichifu NOP 60	TIC 8
2025	22 (4)		M6	R22-6	Nichifu NOP 60 / 150H	TIC 22
2040	60 (1/0)		M8	R60-8	Nichifu NOP 60 / 150H	TIC 60
2060	100 (4/0)		M10	R80-10	Nichifu NOP 150H	TIC 80
2100	200 (4/0)*2		M10	R100-10	Nichifu NOP 150H	TIC 100
4003	2 (14)		M4	R2-4	Nichifu NH 1 / 9	TIC 2
	3.5 (12)			R5.5-4		TIC 3.5
	5.5 (10)					TIC 5.5
4008	3.5 (12)		M4	R5.5-4	Nichifu NH 1 / 9	TIC 3.5
	5.5 (10)					TIC 5.5
4015	8 (8)		M4	R8-4	Nichifu NOP 60	TIC 8
4030	14 (6)		M6	R14-6	Nichifu NOP 60 / 150H	TIC 14
4060	38 (2)		M8	R38-8	Nichifu NOP 60 / 150H	TIC 38
4100	80 (3/0)		M10	R80-10	Nichifu NOP 150H	TIC 80
4215	100 (4/0)*2		M10	R100-10	Nichifu NOP 150H	TIC 100

❖ Type 1

During installation, all conduit hole plugs shall be removed, and all conduit holes shall be used.

Note: Contact Teco for inverter ratings 2125-2150 and 4250- 4425.

Drive Model A510	Fuse Type	
	Manufacturer: Bussmann / FERRAZ SHAWMUT	
	Model	Fuse Ampere Rating (A)
200 V Class Three-Phase Drives		
2001	Bussmann 20CT	690V 20A
2002	Bussmann 30FE	690V 30A
2003	Bussmann 50FE	690V 50A
2005	Bussmann 50FE	690V 50A
2008	Bussmann 63FE	690V 63A
2010	FERRAZ SHAWMUT A50QS100-4	500V 100A
2015	Bussmann 120FEE / FERRAZ A50QS150-4	690V 120A / 500V 150A
2020	FERRAZ SHAWMUT A50QS150-4	500V 150A
2025	FERRAZ SHAWMUT A50QS200-4	500V 200A
2030	FERRAZ SHAWMUT A50QS250-4	500V 250A
2040	FERRAZ SHAWMUT A50QS300-4	500V 300A
2050	FERRAZ SHAWMUT A50QS400-4	500V 400A
2060	FERRAZ SHAWMUT A50QS500-4	500V 500A
2075	FERRAZ SHAWMUT A50QS600-4	500V 600A
2100	FERRAZ SHAWMUT A50QS700-4	500V 700A

Drive Model A510	Fuse Type	
	Manufacturer: Bussmann / FERRAZ SHAWMUT	
	Model	Fuse Ampere Rating (A)
400 V Class Three-Phase Drives		
4001	Bussmann 10CT	690V 10A
4002	Bussmann 16CT	690V 16A
4003	Bussmann 16CT	690V 16A
4005	Bussmann 25ET	690V 25A
4008	Bussmann 40FE	690V 40A
4010	Bussmann 50FE	690V 50A
4015	Bussmann 63FE	690V 63A
4020	Bussmann 80FE	690V 80A
4025	Bussmann 100FE / FERRAZ A50QS100-4	690V 100A / 500V 100A
4030	Bussmann 120FEE	690V 120A
4040	FERRAZ SHAWMUT A50QS150-4	500V 150A
4050	FERRAZ SHAWMUT A50QS200-4	500V 200A
4060	FERRAZ SHAWMUT A50QS250-4	500V 250A
4075	FERRAZ SHAWMUT A50QS300-4	500V 300A
4100	FERRAZ SHAWMUT A50QS400-4	500V 400A
4125	FERRAZ SHAWMUT A50QS500-4	500V 500A
4150	FERRAZ SHAWMUT A50QS600-4	500V 600A
4175	FERRAZ SHAWMUT A50QS700-4	500V 700A
4215	FERRAZ SHAWMUT A50QS700-4	500V 700A

❖ Motor Overtemperature Protection

Motor overtemperature protection shall be provided in the end use application.

■ Field Wiring Terminals

All input and output field wiring terminals not located within the motor circuit shall be marked to indicate the proper connections that are to be made to each terminal and indicate that copper conductors, rated 75°C are to be used.

■ Inverter Short-Circuit Rating

This inverter has undergone the UL short-circuit test, which certifies that during a short circuit in the power

supply the current flow will not rise above value. Please see electrical ratings for maximum voltage and table below for current.

- The MCCB and breaker protection and fuse ratings (refer to the preceding table) shall be equal to or greater than the short-circuit tolerance of the power supply being used.
- Suitable for use on a circuit capable of delivering not more than (A) RMS symmetrical amperes for DiJ2.IHp in 240 / 480 V class drives motor overload protection.

Horse Power (Hp)	Current (A)	Voltage (V)
1 - 50	5,000	240 / 480
51 - 200	10,000	240 / 480
201 - 400	18,000	240 / 480
401 - 600	30,000	240 / 480

❖ Inverter Motor Overload Protection

Set parameter 02-0 I (motor rated current) to the appropriate value to enable motor overload protection. The internal motor overload protection is UL listed and in accordance with the NEC and CEC.

■ 02-01 Motor Rated Current

Setting Range Model Dependent
 Factory Default: Model Dependent

The motor rated current parameter (02-0) protects the motor and allows for proper vector control when using open loop vector or flux vector control methods (00-00 = 2 or 3). The motor protection parameter 08-05 is set as factory default. Set 02-01 to the full load amps (FLA) stamped on the nameplate of the motor. The operator must enter the rated current of the motor (17-02) in the menu during auto-tuning. If the auto-tuning operation completes successfully (17-00 = 0), the value entered into 17-02 will automatically write into 02-0 I.

■ 08-05 Motor Overload Protection Selection

The inverter has an electronic overload protection function (OL1) based on time, output current, and output frequency, which protects the motor from overheating. The electronic thermal overload function is UL-recognized, so it does not require an external thermal overload relay for single motor operation. This parameter selects the motor overload curve used according to the type of motor applied.

08-05	Selection for motor overload protection (OL1)
Range	xxx0b : Motor overload is invalid xxx1b : Motor overload is valid xx0xb : Cold start of motor overload xx1xb : Hot start of motor overload x0xxb : Standard motor x1xxb : Special motor 0xxxb : Reserved 1xxxb : Reserved

Sets the motor overload protection function in 08-05 according to the applicable motor.

08-05 = ---OB: Disables the motor overload protection function when two or more motors are connected to a single inverter. Use an alternative method to provide separate overload protection for each motor such as connecting a thermal overload relay to the power line of each motor.

08-05 = --1-B: The motor overload protection function should be set to hot start protection characteristic curve when the power supply is turned on and off frequently, because the thermal values are reset each time when the power is turned off.

08-05 = -0—B: For motors without a forced cooling fan (general purpose standard motor), the heat dissipation capability is lower when in low speed operation.

08-05 = -1—B: For motors with a forced cooling fan (inverter duty or VIF motor), the heat dissipation capability is not dependent upon the rotating speed.

To protect the motor from overload by using electronic overload protection, be sure to set parameter 02-01 according to the rated current value shown on the motor nameplate.

Refer to the following "Motor Overload Protection Time" for the standard motor overload protection curve example: Setting 08-05 = -0--B.

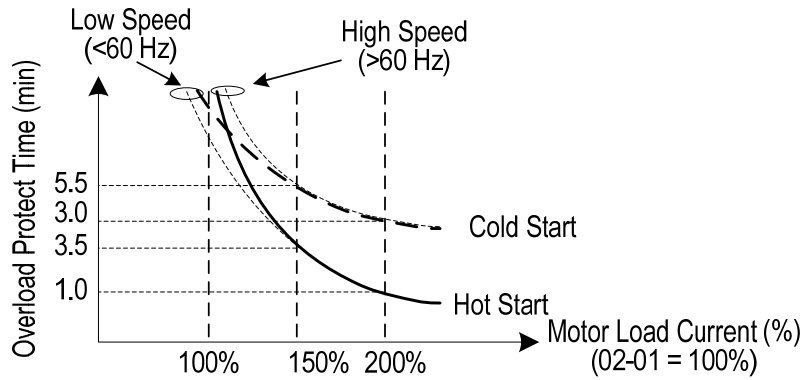

■ **08-06 Motor Overload Operation Selection**

08-06	Start-up mode of overload protection operation (OL1)
Range	0: Stop output after overload protection 1: Continuous operation after overload protection.

08-06=0: When the inverter detects a motor overload the inverter output is turned off and the OL1 fault message will flash on the keypad. Press RESET button on the keypad or activate the reset function through the multi-function inputs to reset the OL1 fault.

08-06=1: When the inverter detects a motor overload the inverter will continue running and the OL1 alarm message will flash on the keypad until the motor current falls within the normal operating range.

UL- Additional Data

Closed-Loop Crimp Terminal Size

Drive Model A510	Wire Gauge mm ² , (AWG)		Terminal	Crimp Terminal	Tool	Insulation Cap
	R/L1 · S/L2 · T/L3	U/T1 · V/T2 · W/T3	Screws	Model No.	Machine No.	Model No.
2125	100 (4/0)		M12	R100-12	Nichifu NOP 150H	TIC 100
2150	100 (4/0)		M12	R100-12	Nichifu NOP 150H	TIC 100
4250	100 (4/0)		M12	R100-12	Nichifu NOP 150H	TIC 100
4300	100 (4/0)		M12	R100-12	Nichifu NOP 150H	TIC 100
4375	100 (4/0)		M12	R100-12	Nichifu NOP 150H	TIC 100
4425	100 (4/0)		M12	R100-12	Nichifu NOP 150H	TIC 100

❖ **Type 1**

During installation, all conduit hole plugs shall be removed, and all conduit holes shall be used

Recommended Input Fuse Selection

Drive Model A510	Fuse Type	
	Manufacturer: Bussmann / FERRAZ SHAWMUT	
	Model	Fuse Ampere Rating (A)
200 V Class Three-Phase Drives		
2125	Bussmann 170M5464	690V 800A
2150	Bussmann 170M5464	690V 800A

Drive Model A510	Fuse Type	
	Manufacturer: Bussmann / FERRAZ SHAWMUT	
	Model	Fuse Ampere Rating (A)
400 V Class Three-Phase Drives		
4250	Bussmann 170M5464	690V 800A
4300	Bussmann 170M5464	690V 800A
4375	Bussmann 170M5466	690V 1000A
4425	Bussmann 170M5466	690V 1000A

Information
provided by
EMAG
Tel: 01902 601403
www.emag-ltd.co.uk

TECO 

TECO Electric & Machinery Co., Ltd.

10F., No.3-1, Yuancyu St., Nangang District,
Taipei City 115, Taiwan
Tel : +886-2-6615-9111
Fax : +886-2-6615-0933

<http://globalsa.teco.com.tw/tw>

Distributor

Ver:03 2013.11

This manual may be modified when necessary because of improvement of the product, modification, or changes in specifications, This manual is subject to change without notice.